



US00D488586S

(12) **United States Design Patent**
Minami

(10) **Patent No.:** **US D488,586 S**

(45) **Date of Patent:** **** Apr. 13, 2004**

(54) **AUTOMATIC HAIR WASHER**

(75) **Inventor:** **Nobuyuki Minami, Osaka (JP)**

(73) **Assignee:** **Oohiro Works, Ltd., Osaka (JP)**

(**) **Term:** **14 Years**

(21) **Appl. No.:** **29/124,731**

(22) **Filed:** **Jun. 9, 2000**

(30) **Foreign Application Priority Data**

Dec. 17, 1999 (JP) 11-34788

(51) **LOC (7) Cl.** **28-03**

(52) **U.S. Cl.** **D28/20**

(58) **Field of Search** D28/9, 10, 20,
D28/99, 19; D32/1; 132/212, 272, 333;
4/515, 523

(56) **References Cited**

U.S. PATENT DOCUMENTS

3,521,647 A * 7/1970 Mercer 132/272
5,025,514 A * 6/1991 Miller 4/518
5,906,012 A * 5/1999 Sakane et al. 4/519

FOREIGN PATENT DOCUMENTS

JP 406078821 A * 3/1994 4/519
JP 406078824 A * 3/1994 4/519
JP 916105 1/1995
JP 916105-1 8/1999
KR 0264494 8/2000

OTHER PUBLICATIONS

A color copy of a brochure of "Auto Shampoo Shamplize" issued by Oohiro Works, Ltd., in which "Shamplize" developed by Oohiro Works, Ltd. and Toto Ltd., is shown.—undated.

A color copy of a brochure of "Auto Shampoo Shamplize II 2001" issued by Oohiro Works, Ltd., in which "Shamplize II 2001" is shown.—undated.

"Aqua Vibro 2," brochure issued by Takara Belmont Group, Japanese Design Application HC10018535 filed Aug. 25, 1998.

"Beauty Salon Equipment Lineup Catalog," a brochure issued by Takara Belmont Group, featuring "Aqua Vibro 802".

"SAS1200 Kikuboshizenjidousenpatsuki Auto Shampoo," an automatic shampoo machine developed by Kabushiki Kaisha Kikuboshi and Sanyo Electric Co., Ltd.

* cited by examiner

Primary Examiner—Ted Shooman

Assistant Examiner—C Tuttle

(74) *Attorney, Agent, or Firm*—Burr & Brown

(57) **CLAIM**

The ornamental design for an automatic hair washer, as shown and described.

DESCRIPTION

FIG. 1 is a front view of the automatic hair washer in accordance with my new design;

FIG. 2 is a back view thereof;

FIG. 3 is a right side view thereof;

FIG. 4 is a left side view thereof;

FIG. 5 is a top view thereof;

FIG. 6 is a bottom view thereof; and,

FIG. 7 is a perspective view thereof.

The broken lines in FIGS. 1, 2, 3, 4, 5 and 7 immediately adjacent to solid lines define the bounds of the claimed design; all other broken lines are for illustrative purposes only. None of the broken lines form a part of the present claim.

1 Claim, 6 Drawing Sheets

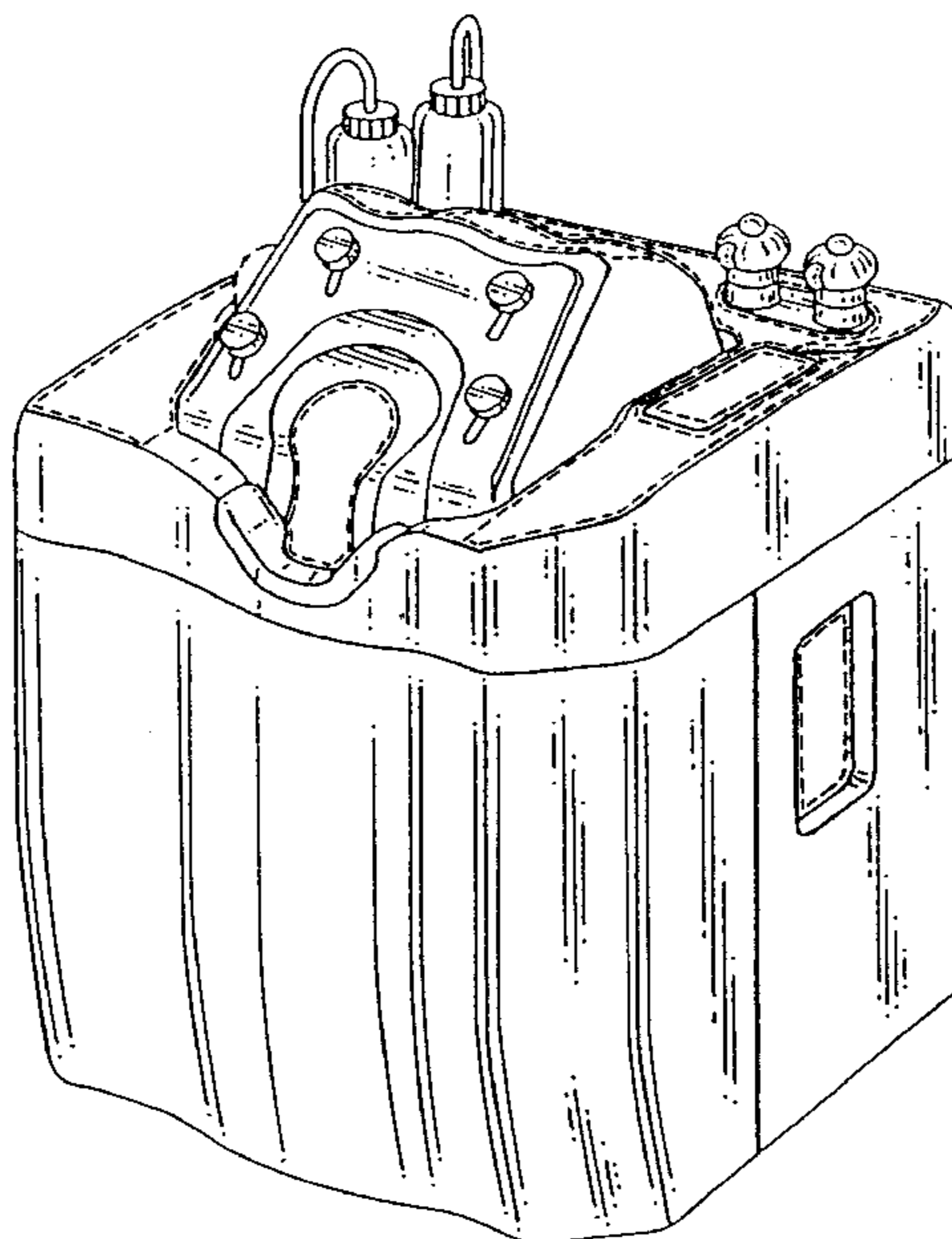

Fig.1

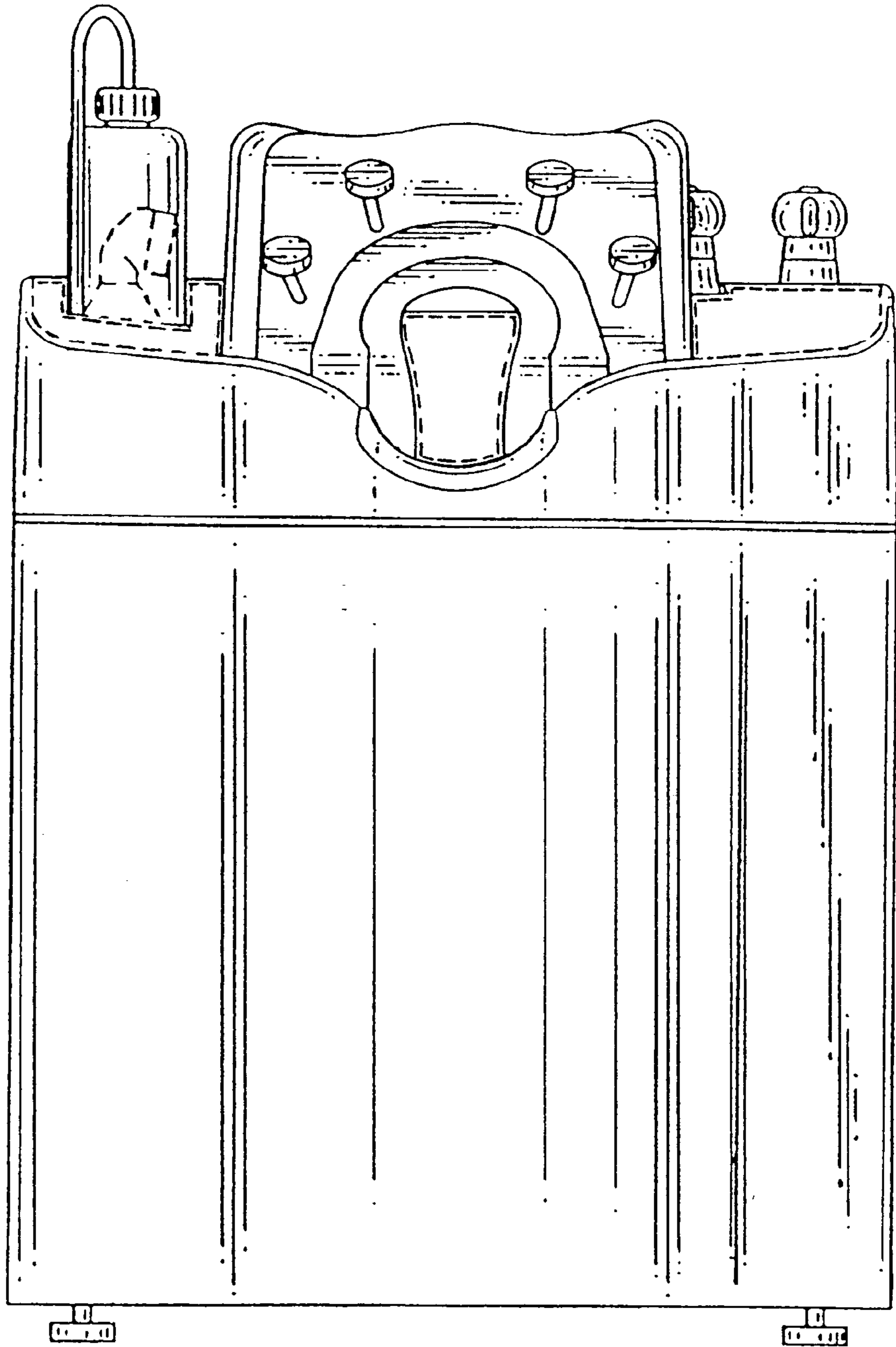

Fig.2

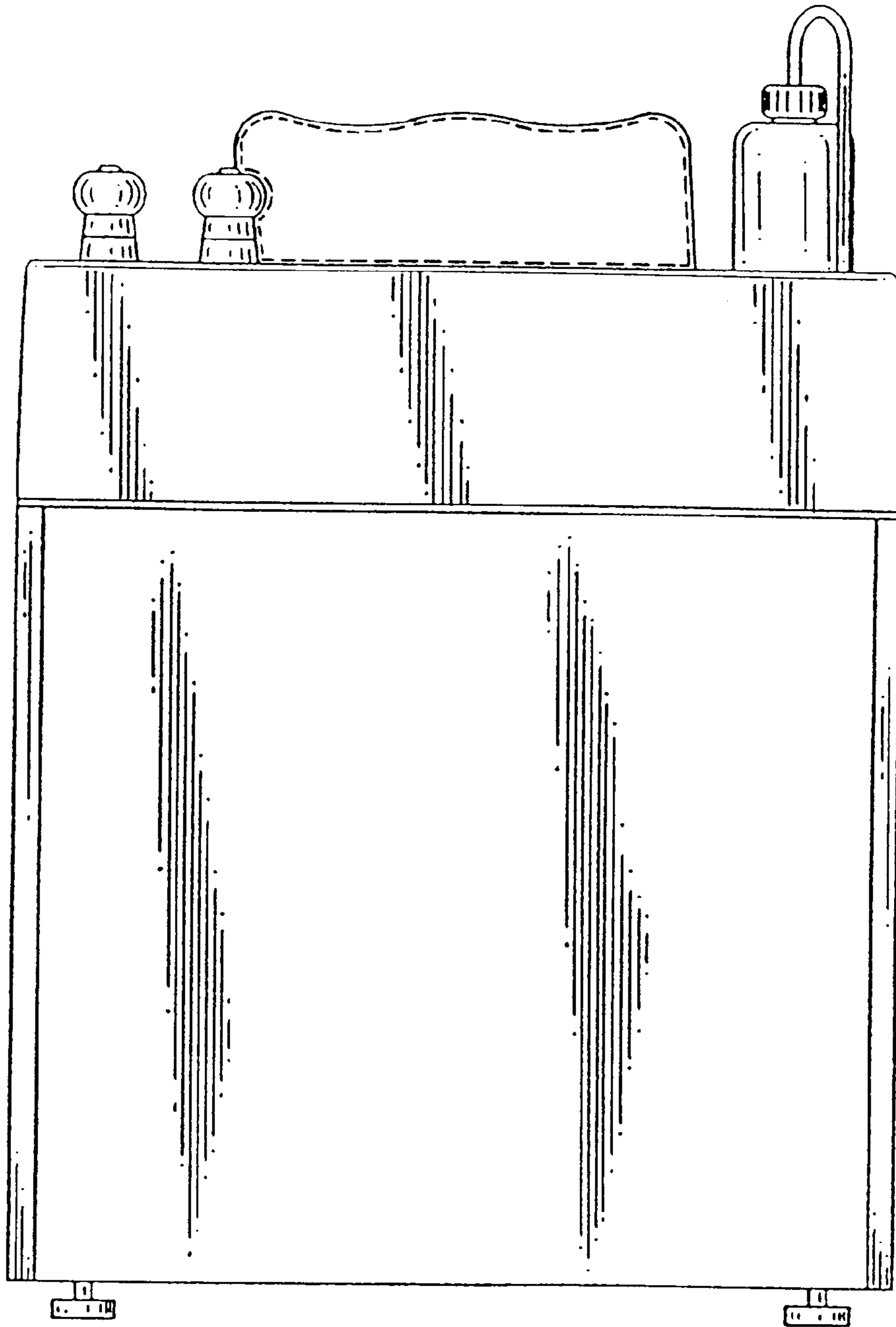

Fig.3

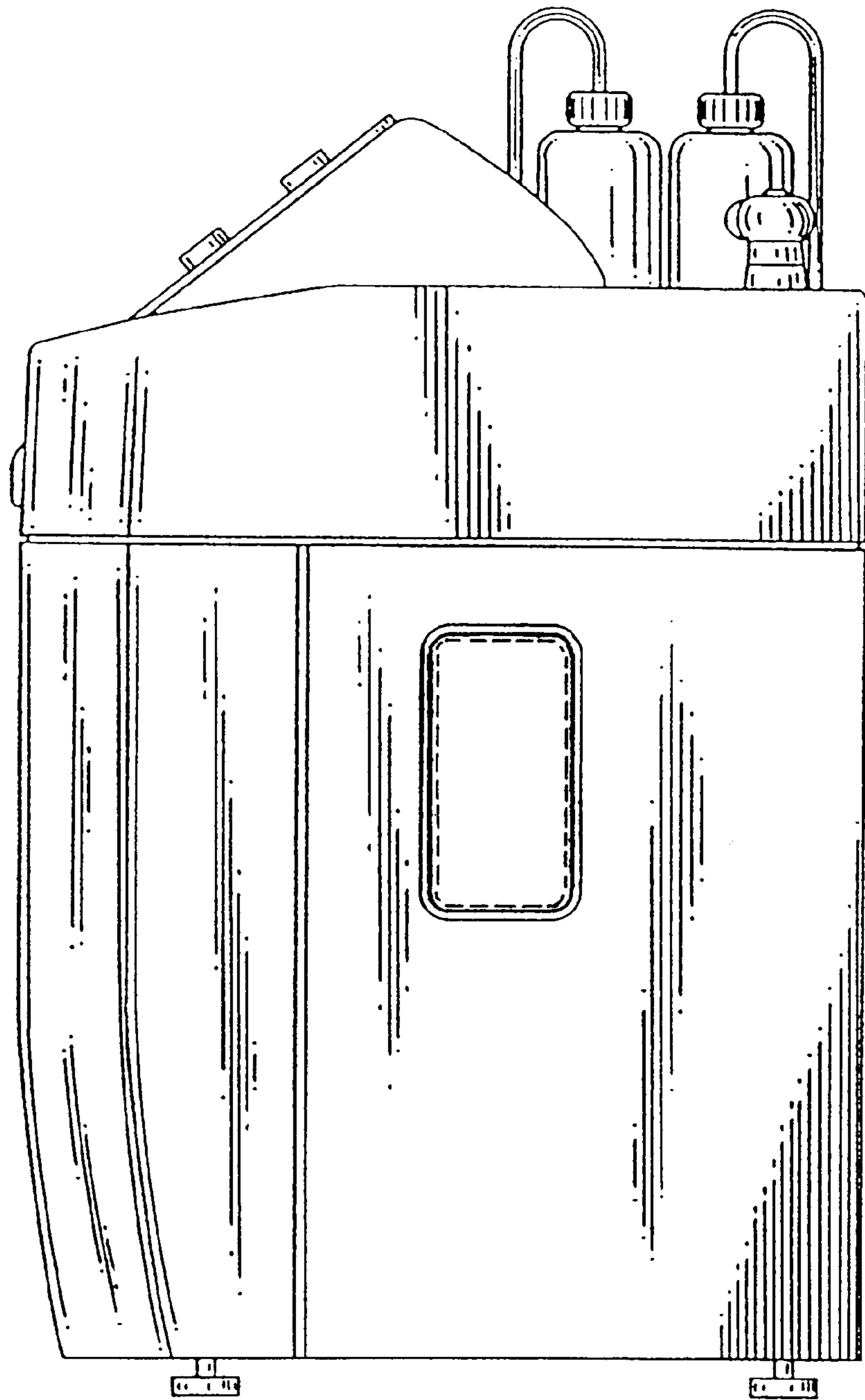

Fig.4

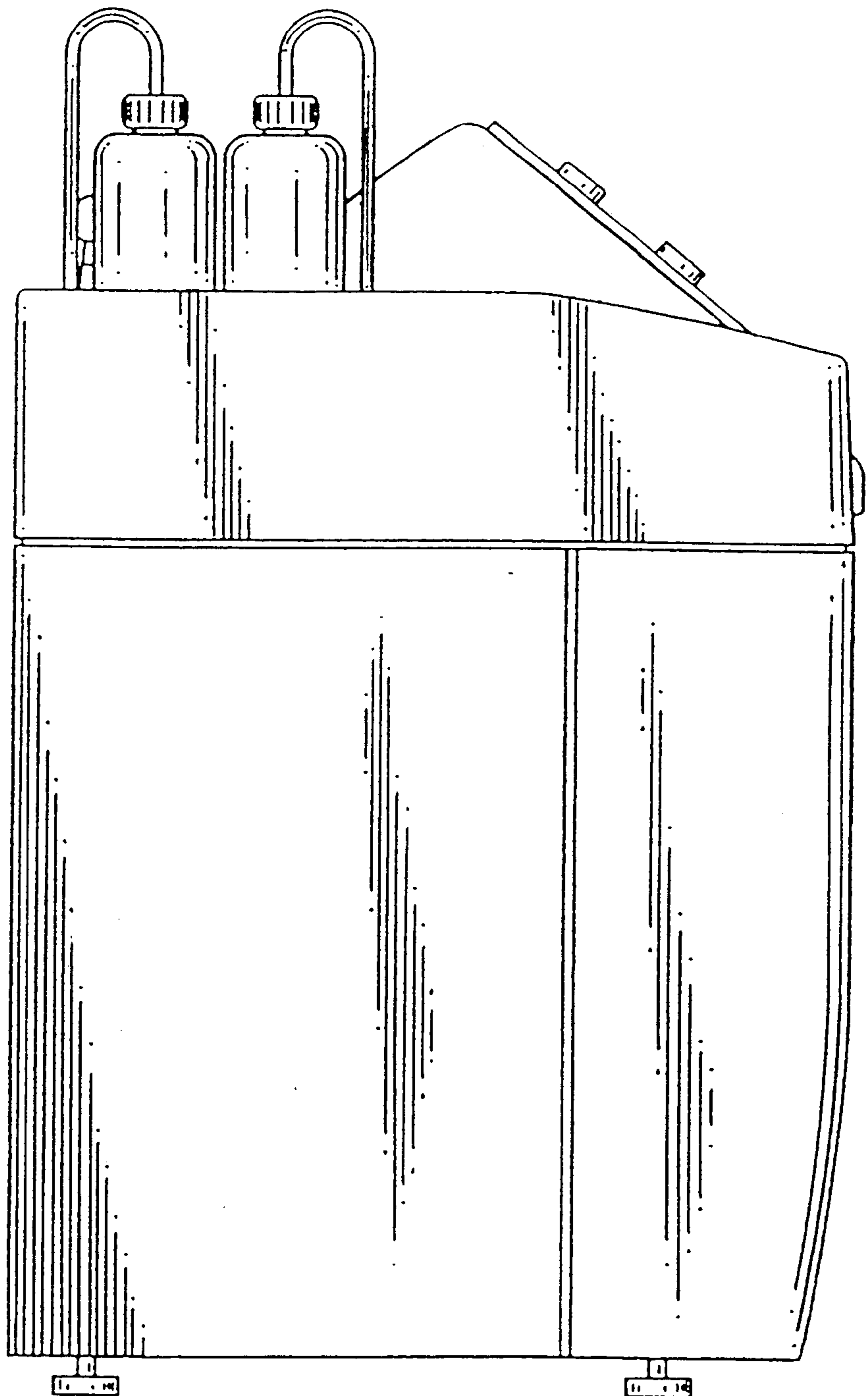

Fig.5

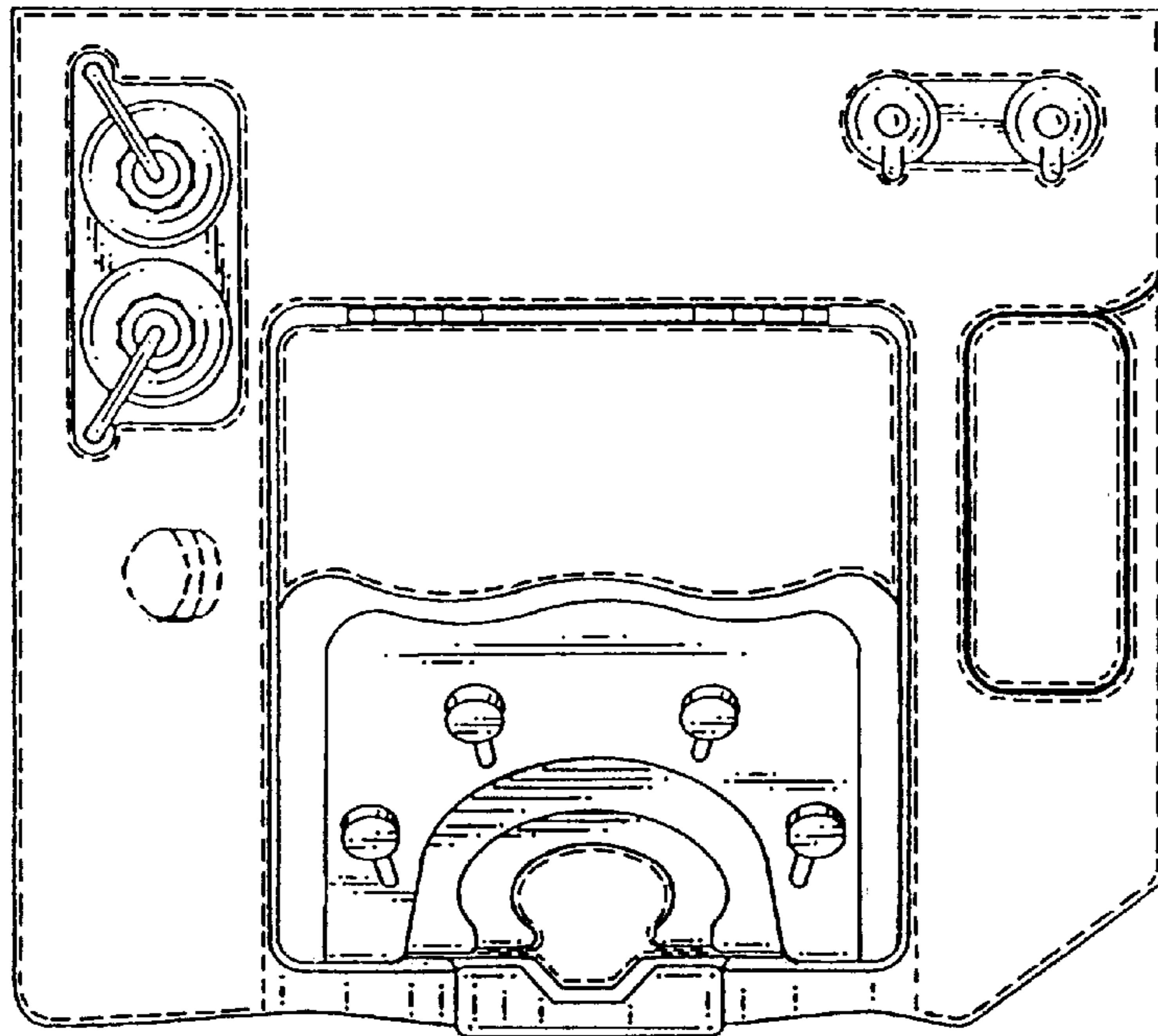

Fig.6

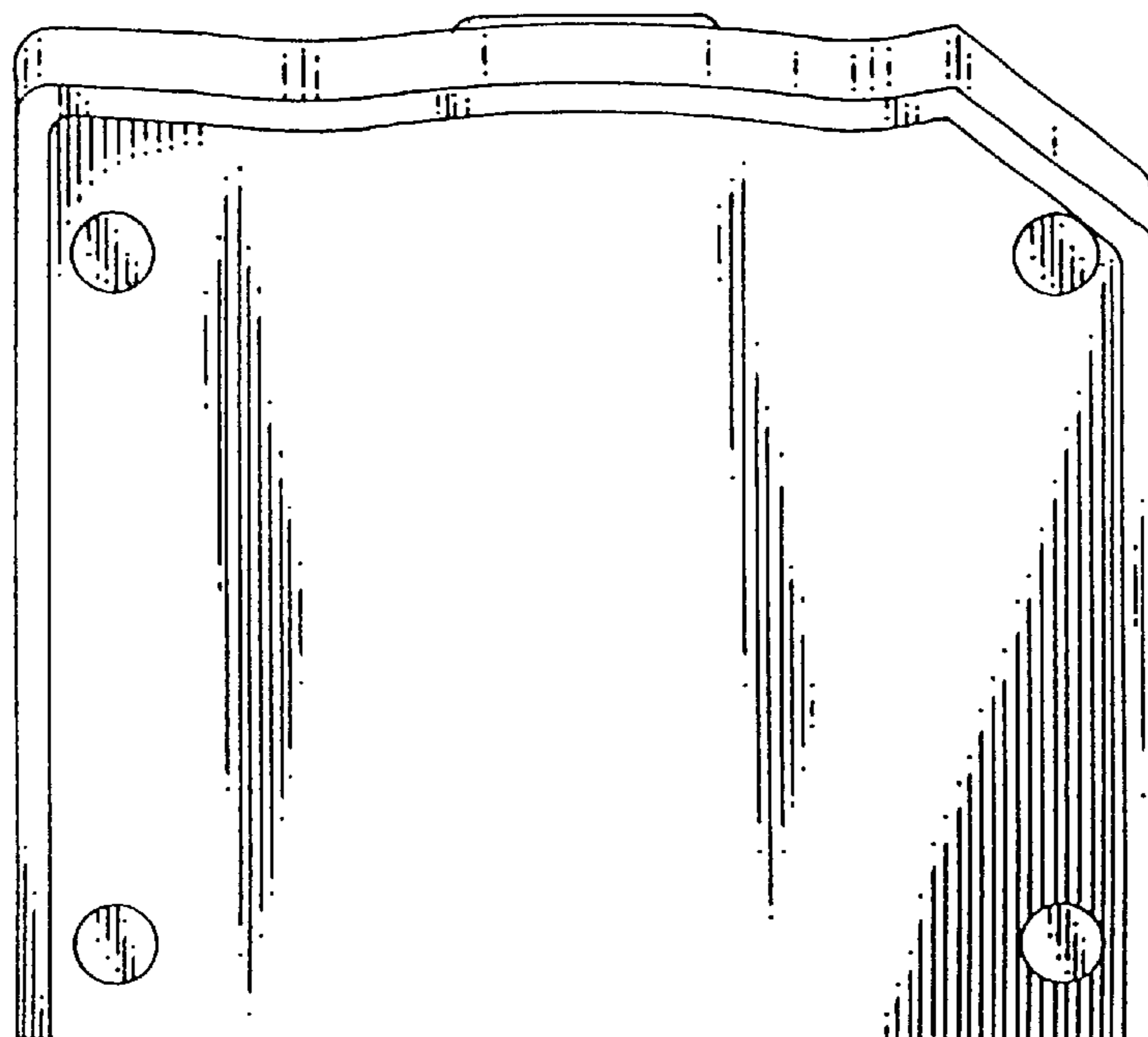
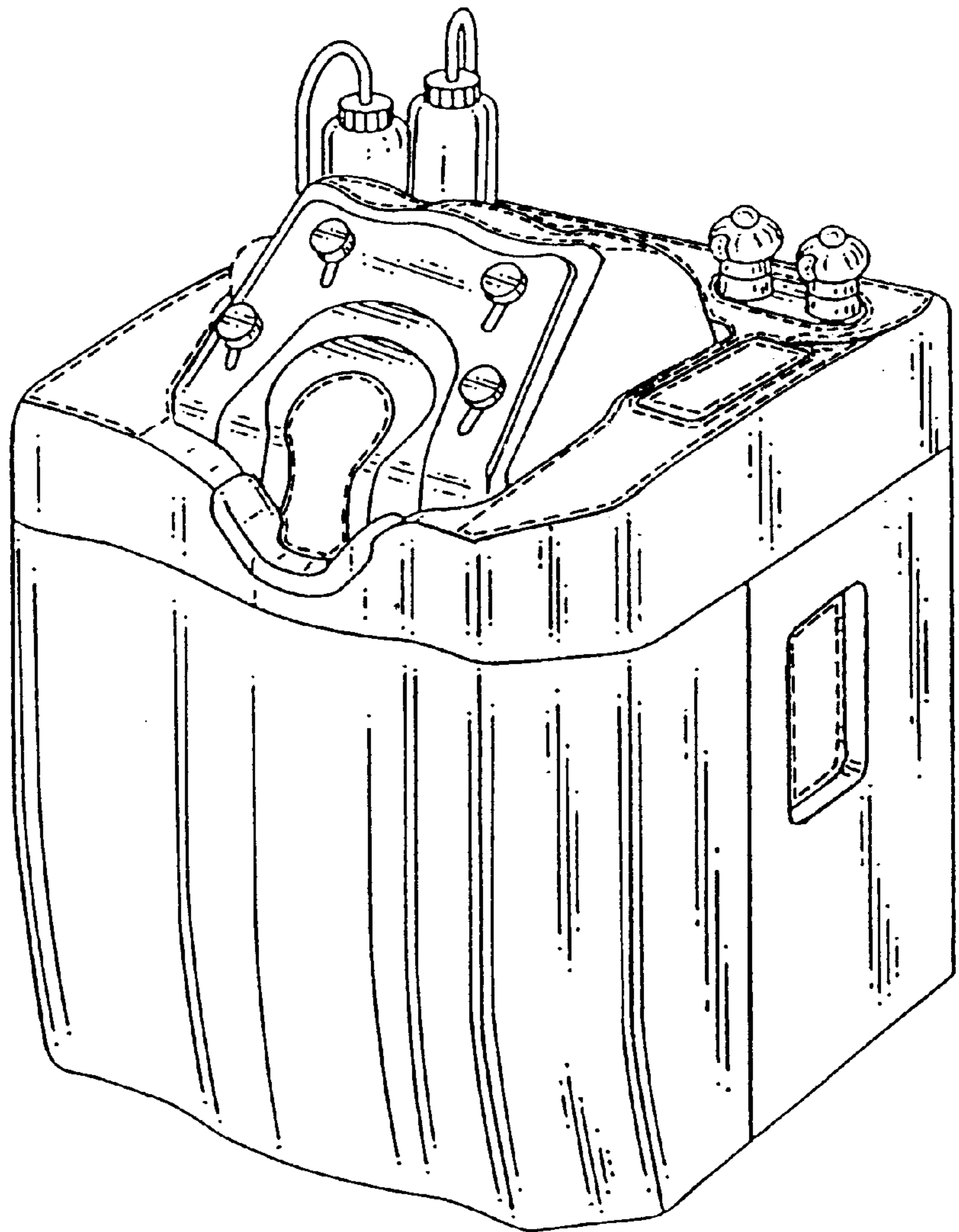

Fig.7



UNITED STATES PATENT AND TRADEMARK OFFICE
CERTIFICATE OF CORRECTION

PATENT NO. : Des. 488,586 S
APPLICATION NO. : 29/124731
DATED : April 13, 2004
INVENTOR(S) : Nobuyuki Minami

Page 1 of 8

It is certified that error appears in the above-identified patent and that said Letters Patent is hereby corrected as shown below:

Delete the title page and the drawings to be replaced with the attached title page and drawings.

Signed and Sealed this

Nineteenth Day of September, 2006

A handwritten signature in black ink on a light gray dotted background. The signature reads "Jon W. Dudas" in a cursive style.

JON W. DUDAS

Director of the United States Patent and Trademark Office

(12) **United States Design Patent** (10) **Patent No.:** **US D488,586 S**
Minami (45) **Date of Patent:** **** Apr. 13, 2004**

(54) **AUTOMATIC HAIR WASHER**

(75) **Inventor:** Nobuyuki Minami, Osaka (JP)

(73) **Assignee:** Oohiro Works, Ltd., Osaka (JP)

(**) **Term:** 14 Years

(21) **Appl. No.:** 29/124,731

(22) **Filed:** Jun. 9, 2000

(30) **Foreign Application Priority Data**

Dec. 17, 1999 (JP) 11-34788

(51) **LOC (7) Cl.** 28-03

(52) **U.S. Cl.** D28/20

(58) **Field of Search** D28/9, 10, 20,
D28/99, 19; D32/1; 132/212, 272, 333;
4/515-523

(56) **References Cited**

U.S. PATENT DOCUMENTS

3,521,647 A * 7/1970 Meroer 132/272
5,025,514 A * 6/1991 Miller 4/518
5,906,012 A * 5/1999 Sakane et al. 4/519

FOREIGN PATENT DOCUMENTS

JP 406078821 A * 3/1994 4/519
JP 406078824 A * 3/1994 4/519
JP 916105 1/1995
JP 916105-1 8/1999
KR 0264494 8/2000

OTHER PUBLICATIONS

A color copy of a brochure of "Auto Shampoo Shamplize" issued by Oohiro Works, Ltd., in which "Shamplize" developed by Oohiro Works, Ltd., and Toto Ltd., is shown, undated.

A color copy of a brochure of "Auto Shampoo Shamplize II 2001" issued by Oohiro Works, Ltd., in which "Shamplize II 2001" is shown, undated.

"Aqua Vibro 2," brochure issued by Takara Belmont Group, Japanese Design Application HC10018535 filed Aug. 25, 1998.

"Beauty Salon Equipment Lineup Catalog," a brochure issued by Takara Belmont Group, featuring "Aqua Vibro 802".

"SAS1200 Kikuboshizenjidousenpatsuki Auto Shampoo," an automatic shampoo machine developed by Kabushiki Kaisha Kikuboshi and Sanyo Electric Co., Ltd.

* cited by examiner

Primary Examiner—Ted Shooman

Assistant Examiner—C Tuttle

(74) *Attorney, Agent, or Firm*—Burr & Brown

(57) **CLAIM**

The ornamental design for an automatic hair washer, as shown and described.

DESCRIPTION

FIG. 1 is a front view of the automatic hair washer in accordance with my new design;

FIG. 2 is a back view thereof;

FIG. 3 is a right side view thereof;

FIG. 4 is a left side view thereof;

FIG. 5 is a top view thereof;

FIG. 6 is a bottom view thereof; and,

FIG. 7 is a perspective view thereof.

The portions shown in broken lines are for illustrative purposes only and form no part of the claimed design.

1 Claim, 6 Drawing Sheets

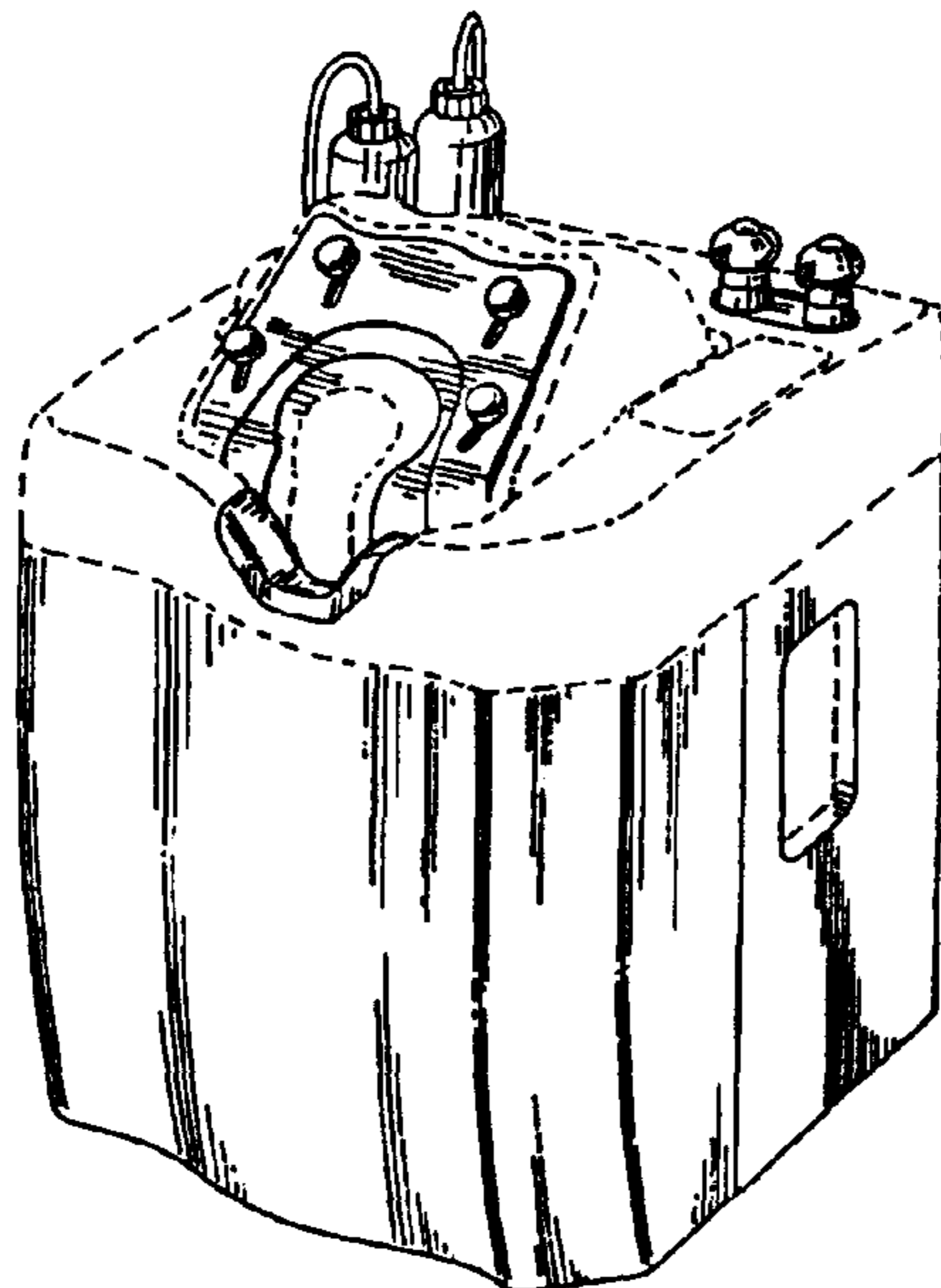

Fig. 1

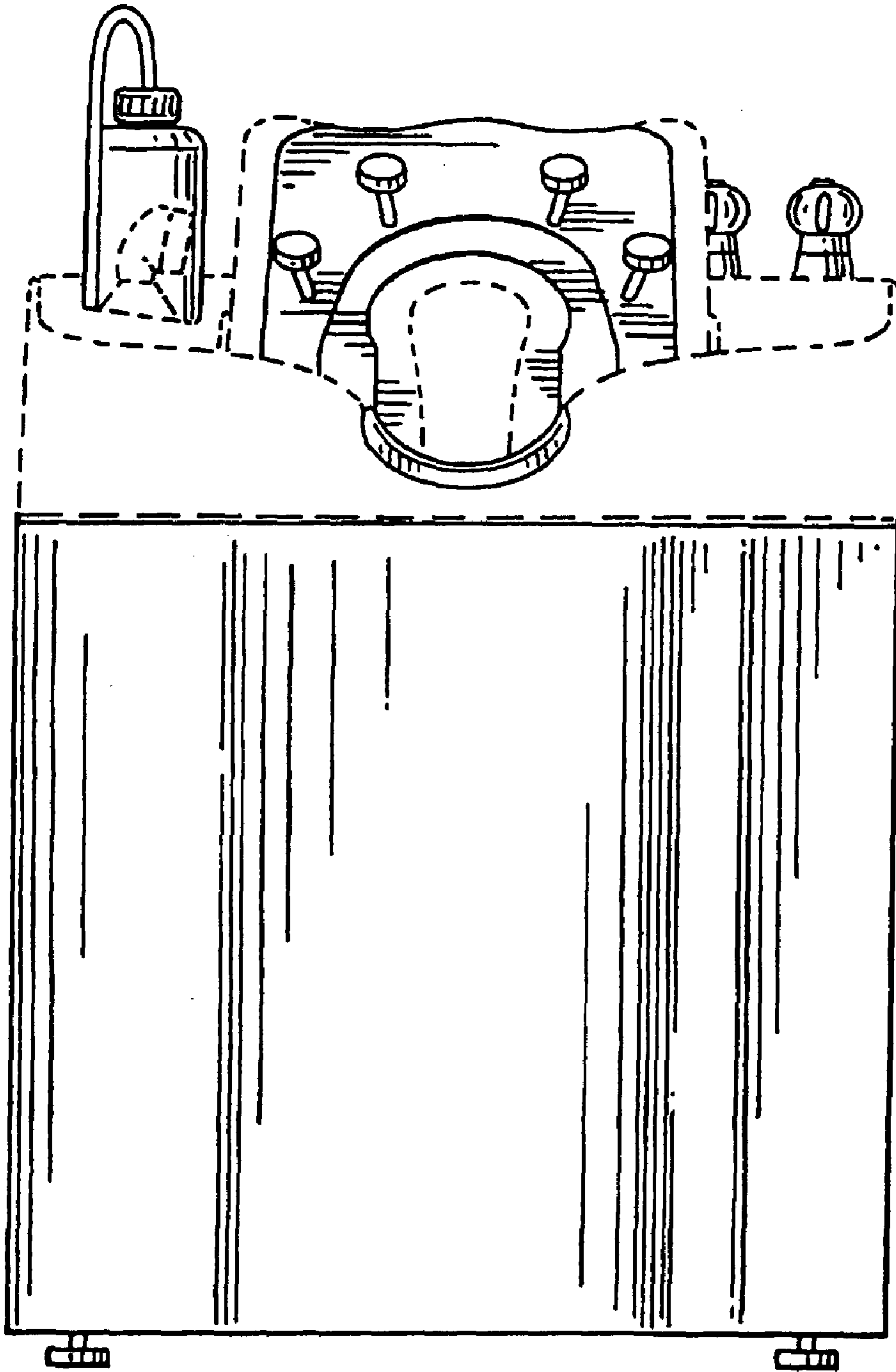

Fig. 2

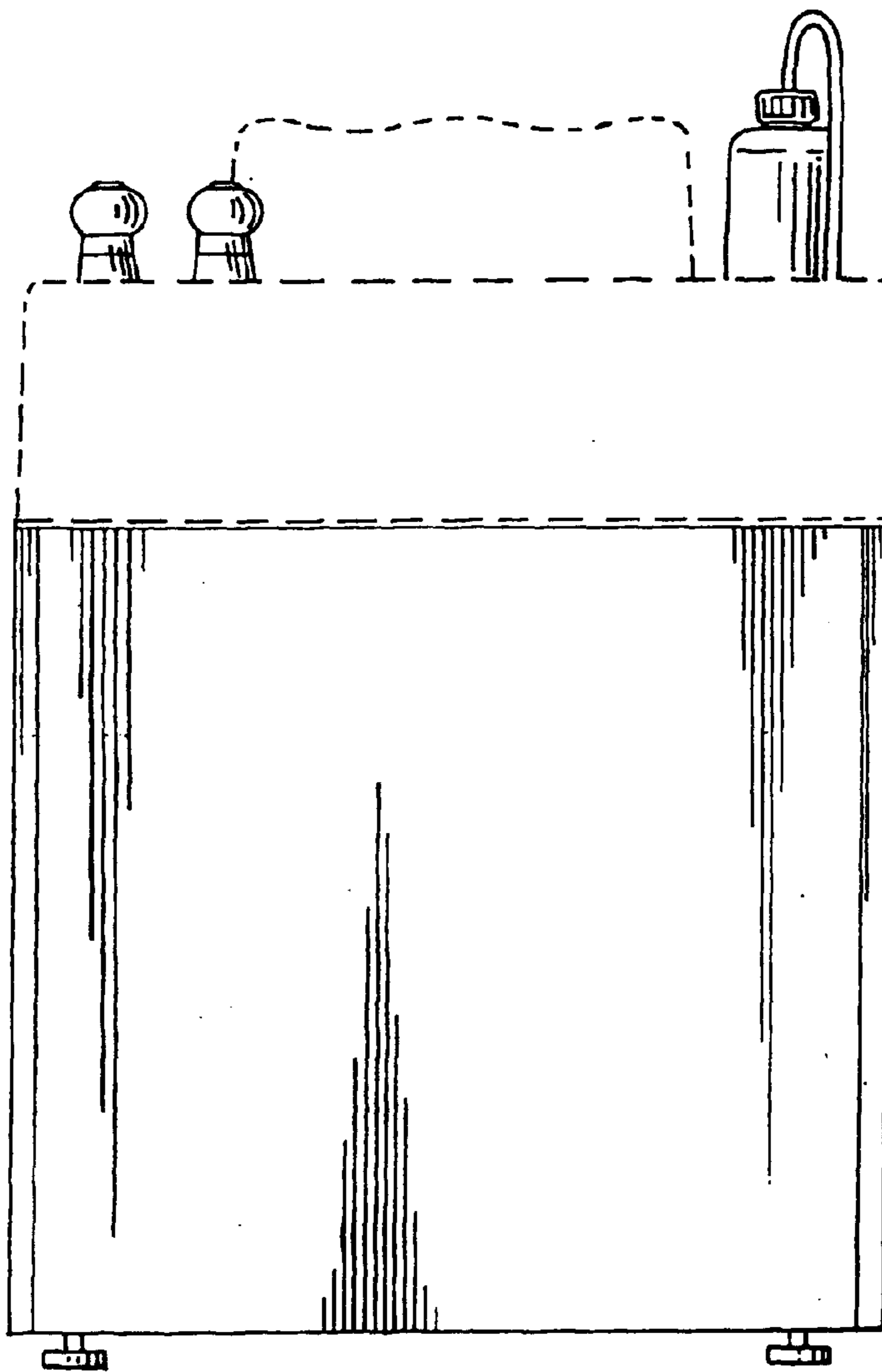

Fig. 3

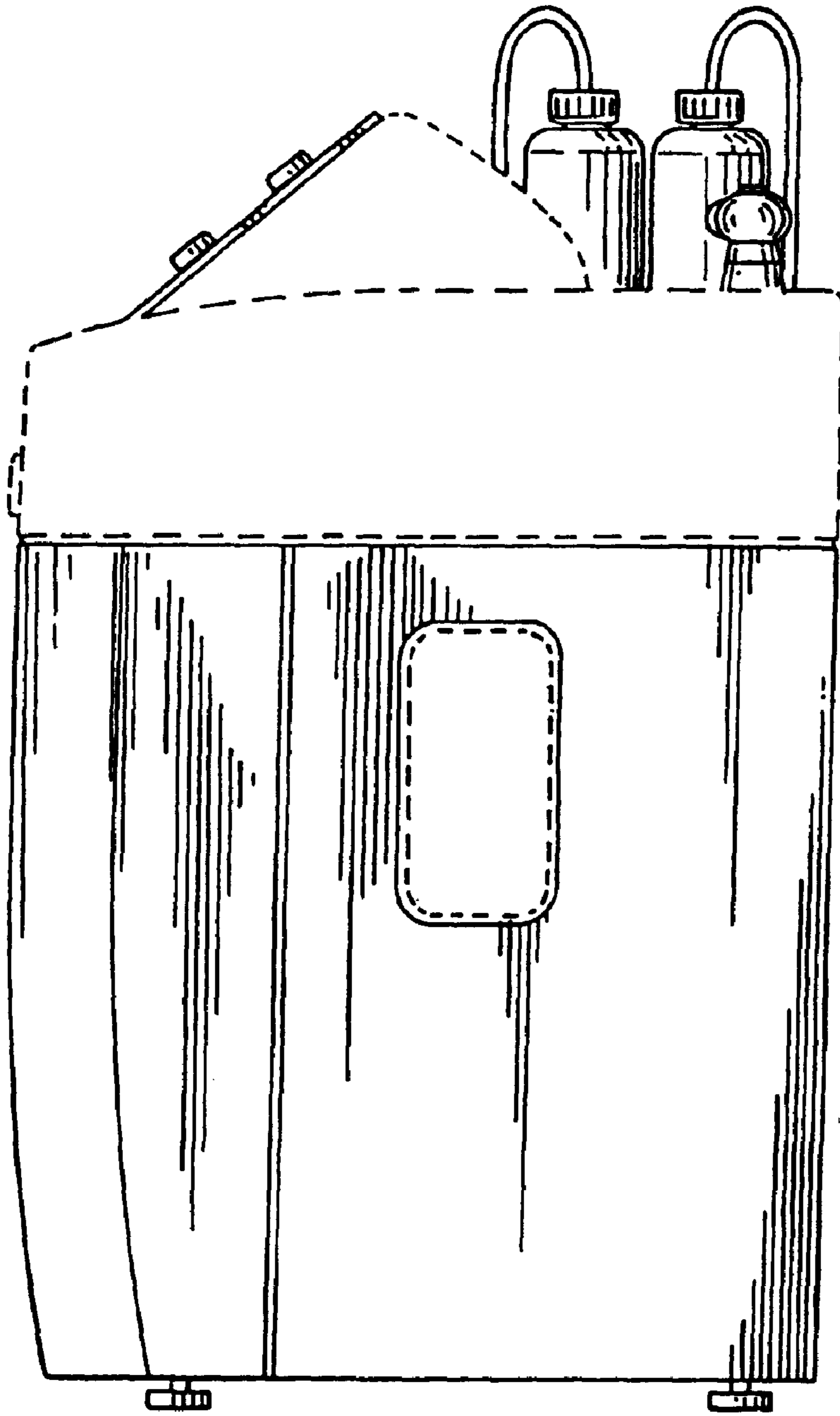

Fig. 4

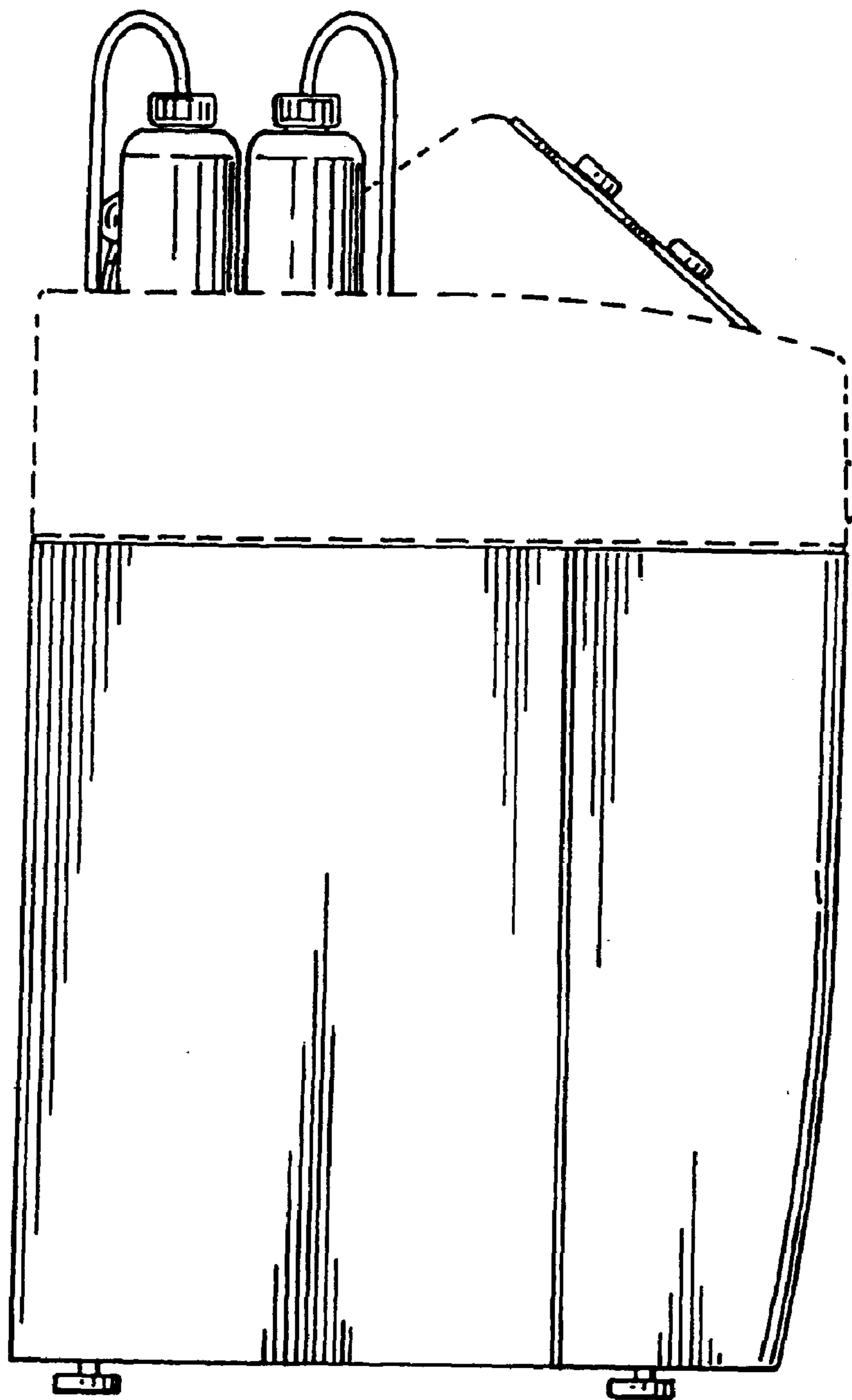

Fig. 5

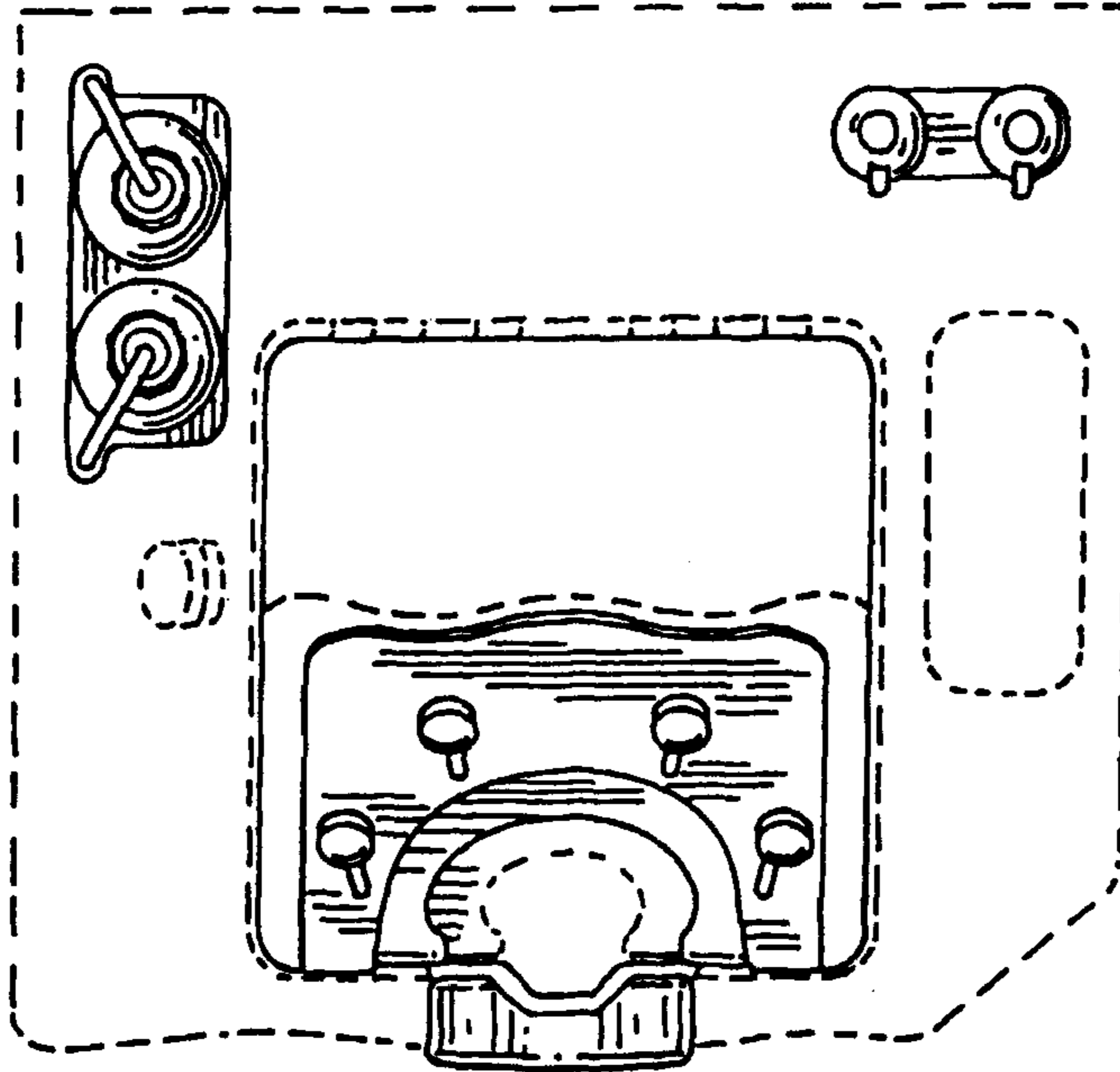

Fig. 6

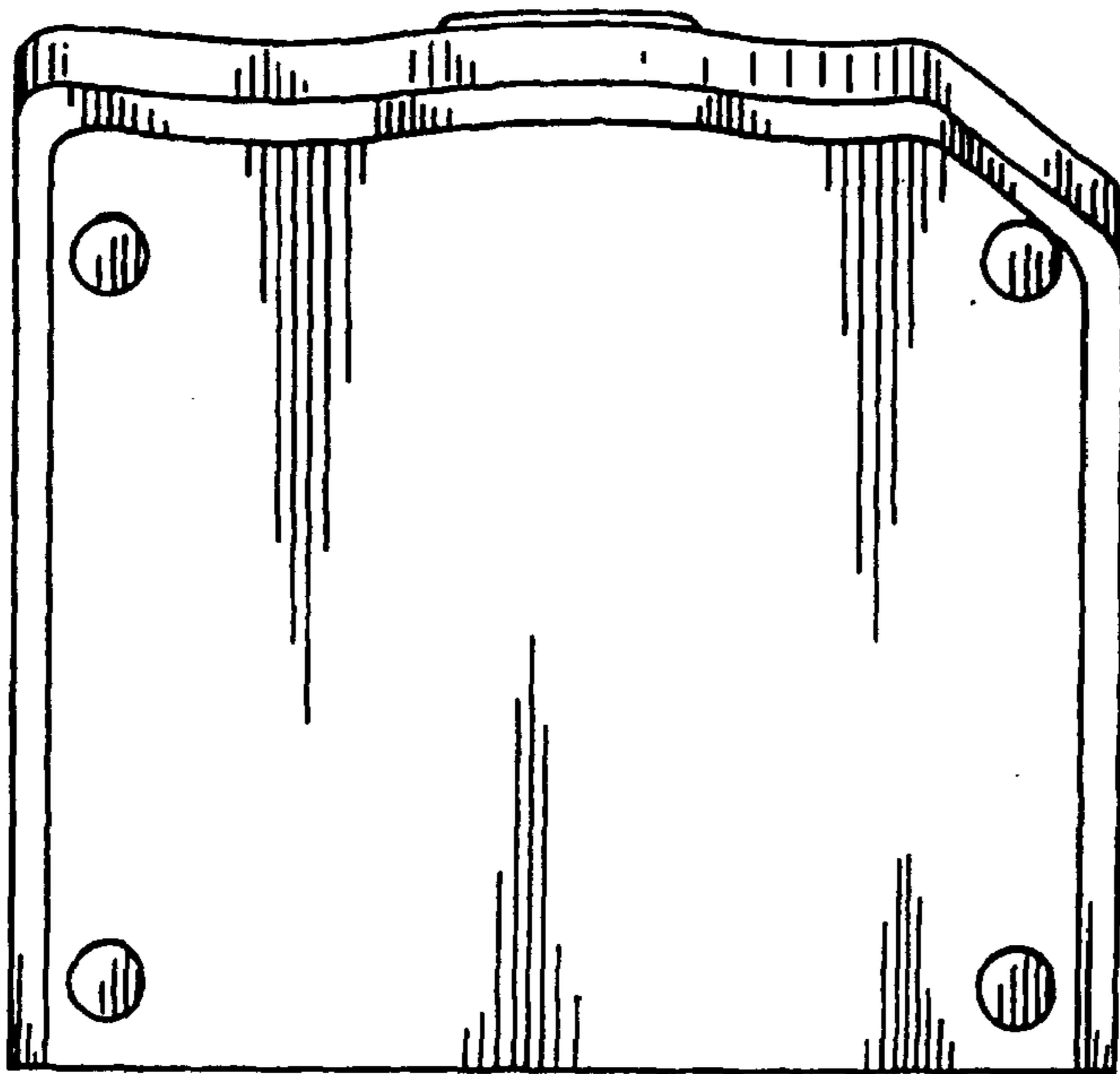

Fig. 7

