



US00D488579S

(12) **United States Design Patent**
Painter et al.

(10) **Patent No.:** **US D488,579 S**

(45) **Date of Patent:** **** Apr. 13, 2004**

(54) **WALL SCONCE**

(75) Inventors: **Michael J. Painter**, Columbus, OH (US); **Christopher P. Marks**, Pickerington, OH (US); **Paul P. Kolada**, Bexley, OH (US)

(73) Assignee: **American Standard International Inc.**, New York, NY (US)

(**) Term: **14 Years**

(21) Appl. No.: **29/167,307**

(22) Filed: **Sep. 12, 2002**

(51) **LOC (7) Cl.** **26-03**

(52) **U.S. Cl.** **D26/92**

(58) **Field of Search** D8/72, 80-92,
D8/138; 362/147, 404-408, 431, 432, 362,
806, 237

(56) **References Cited**

U.S. PATENT DOCUMENTS

- 1,012,234 A * 12/1911 Beardslee 362/406
- D48,278 S * 12/1915 Guth D26/91
- 1,233,829 A * 7/1917 White 362/432

OTHER PUBLICATIONS

Rejuvenation Lamp & Fixture Company Catalog (c) 1999, p. 51, the "Webster", "Cape Meares and Austin" wall fixtures.*

Rejuvenation Lamp & Fixture Company (c) 1999; p. 50 ; "Pacific City" single mission style wall bracket in top right photo. Model #W707.*

Rejuvenation Lamp & Fixture Company Catalog (c) 1999; p. 6; classic "mission" style wall bracket in top right of page.*

Rejuvenation Lamp & Fixture Company Catalog (c)1999, p. 85; glass shade # 174CE.*

* cited by examiner

Primary Examiner—Clare Heflin

(57) **CLAIM**

The ornamental design for a wall sconce, as shown and described.

DESCRIPTION

FIG. 1 is a front perspective view of a preferred embodiment of a wall sconce showing our new design;

FIG. 2 is a top view of the wall sconce of FIG. 1;

FIG. 3 is a bottom view of the wall sconce of FIG. 1;

FIG. 4 is a front view of the wall sconce of FIG. 1;

FIG. 5 is a back view of the wall sconce of FIG. 1;

FIG. 6 is a left side view of the wall sconce of FIG. 1; and,

FIG. 7 is a right side view of the wall sconce of FIG. 1.

The broken lines shown on the drawings are for illustrative purposes only and form no part of the claimed design.

1 Claim, 7 Drawing Sheets

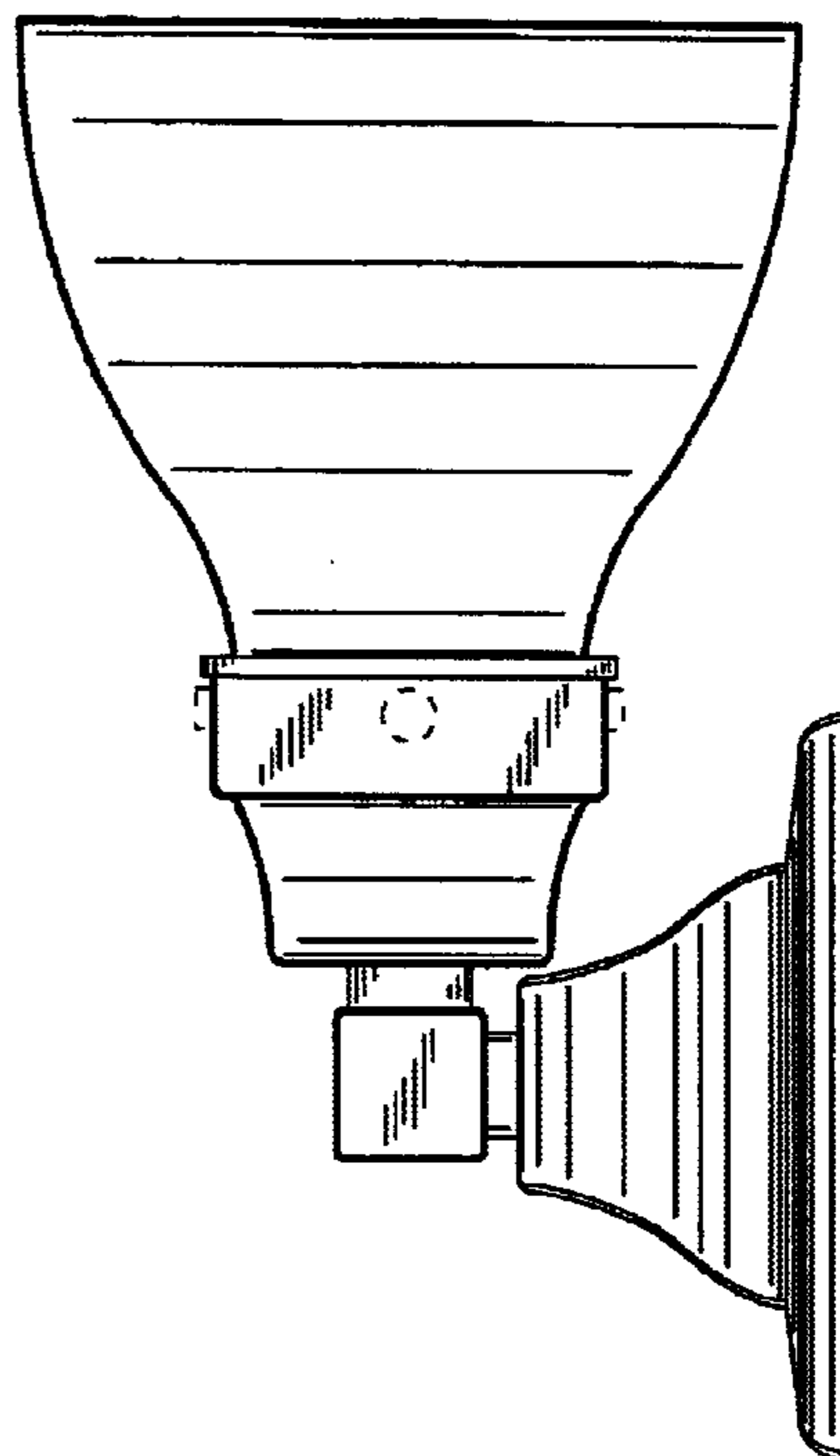
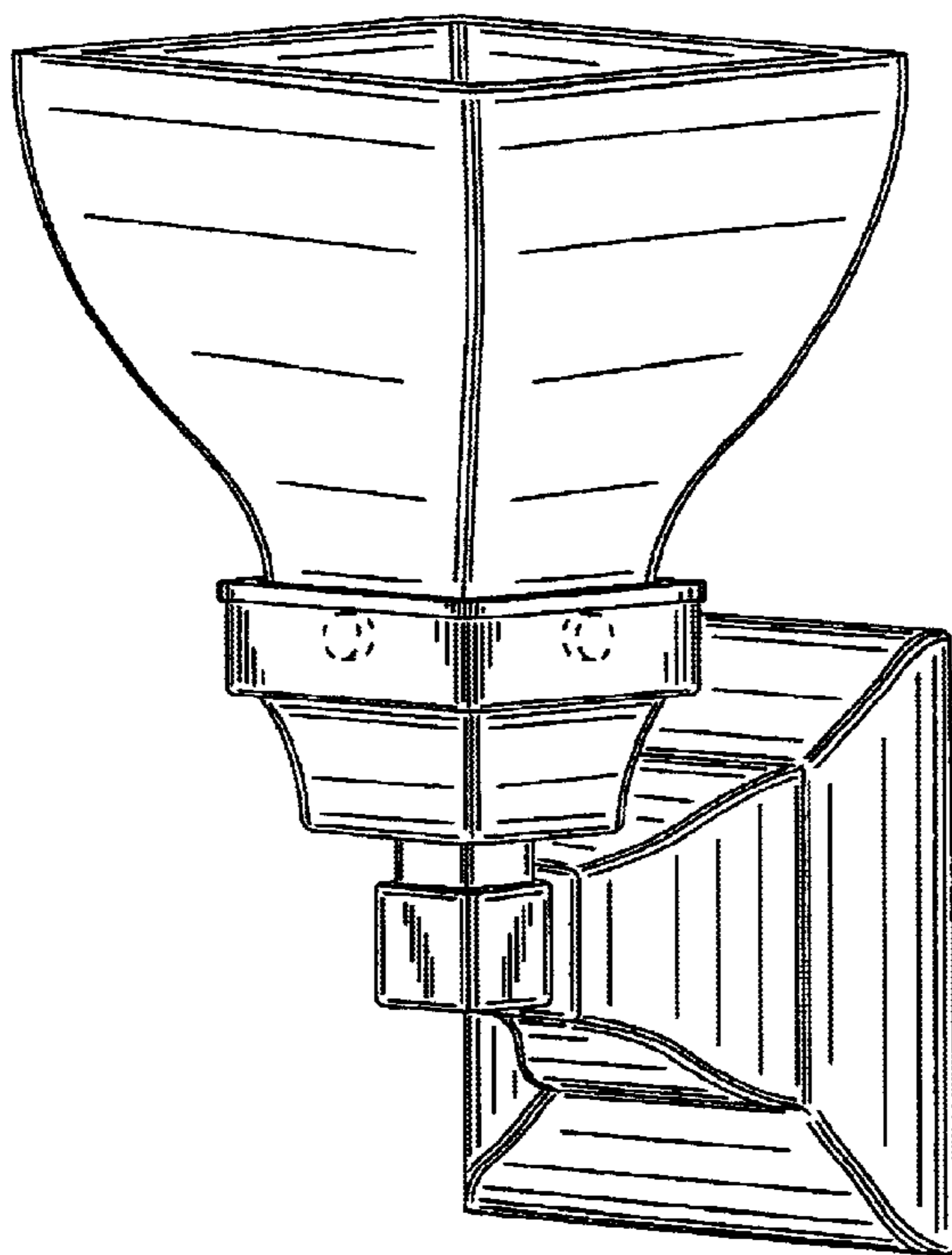

FIG. 1

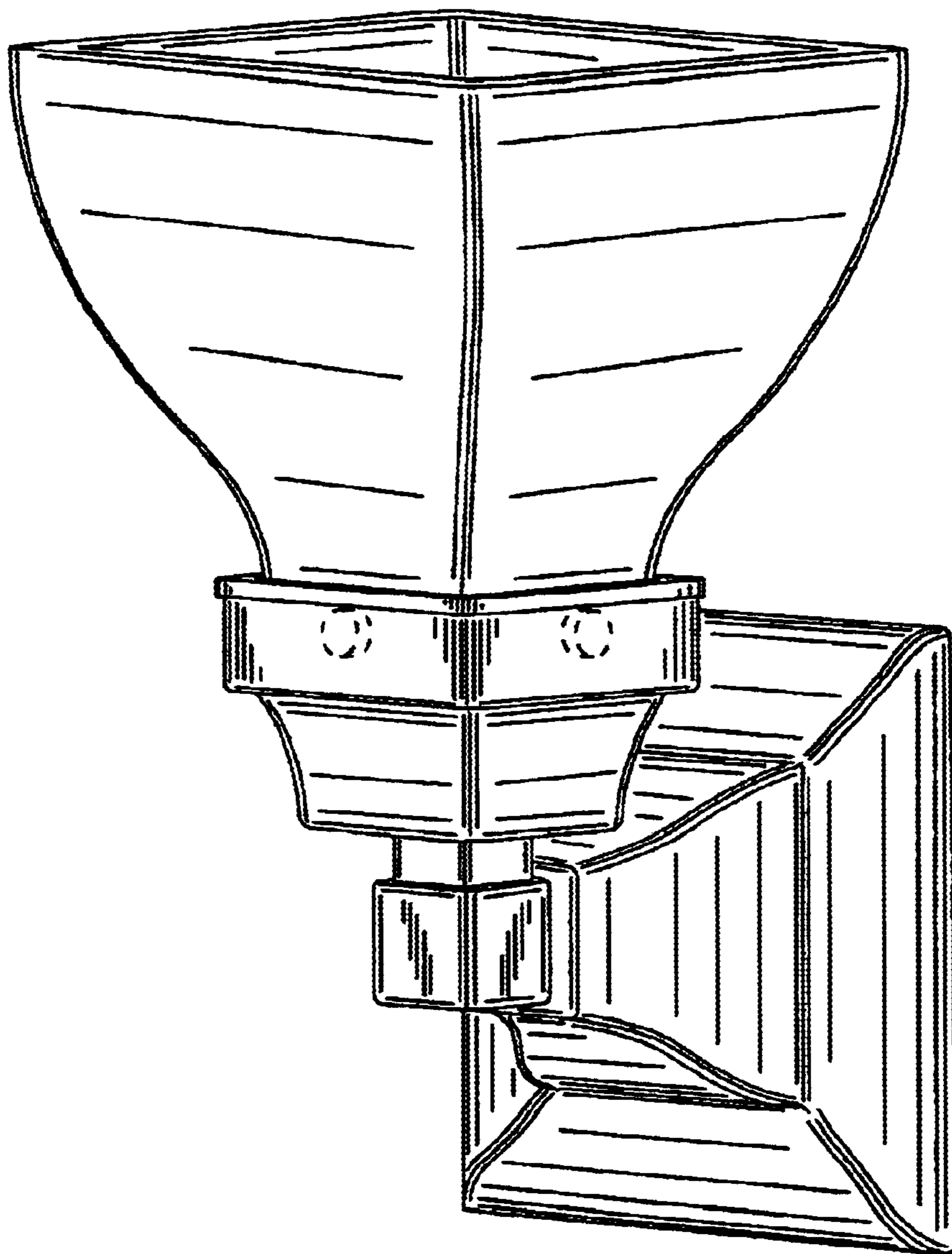

FIG. 2

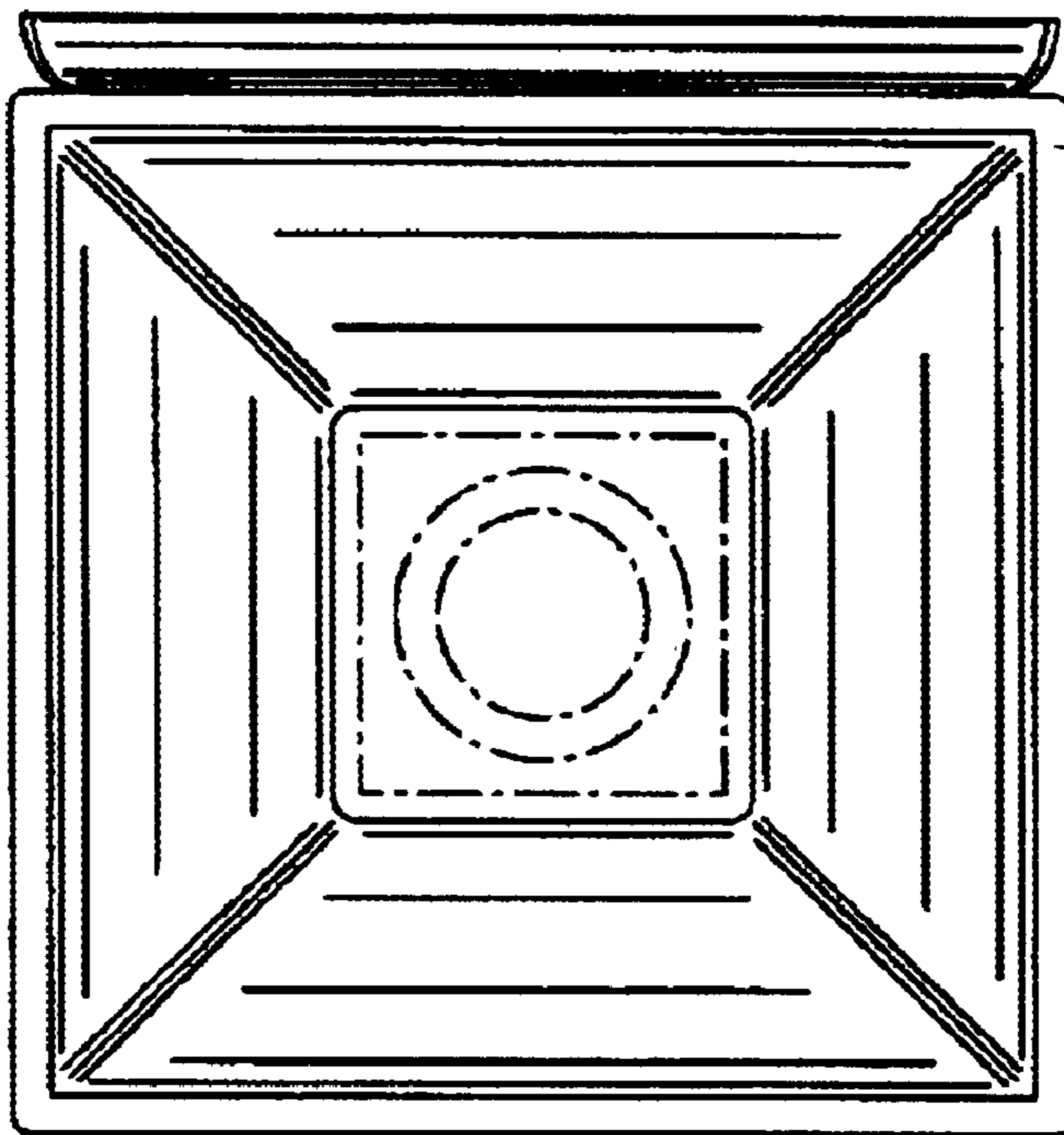

FIG. 3

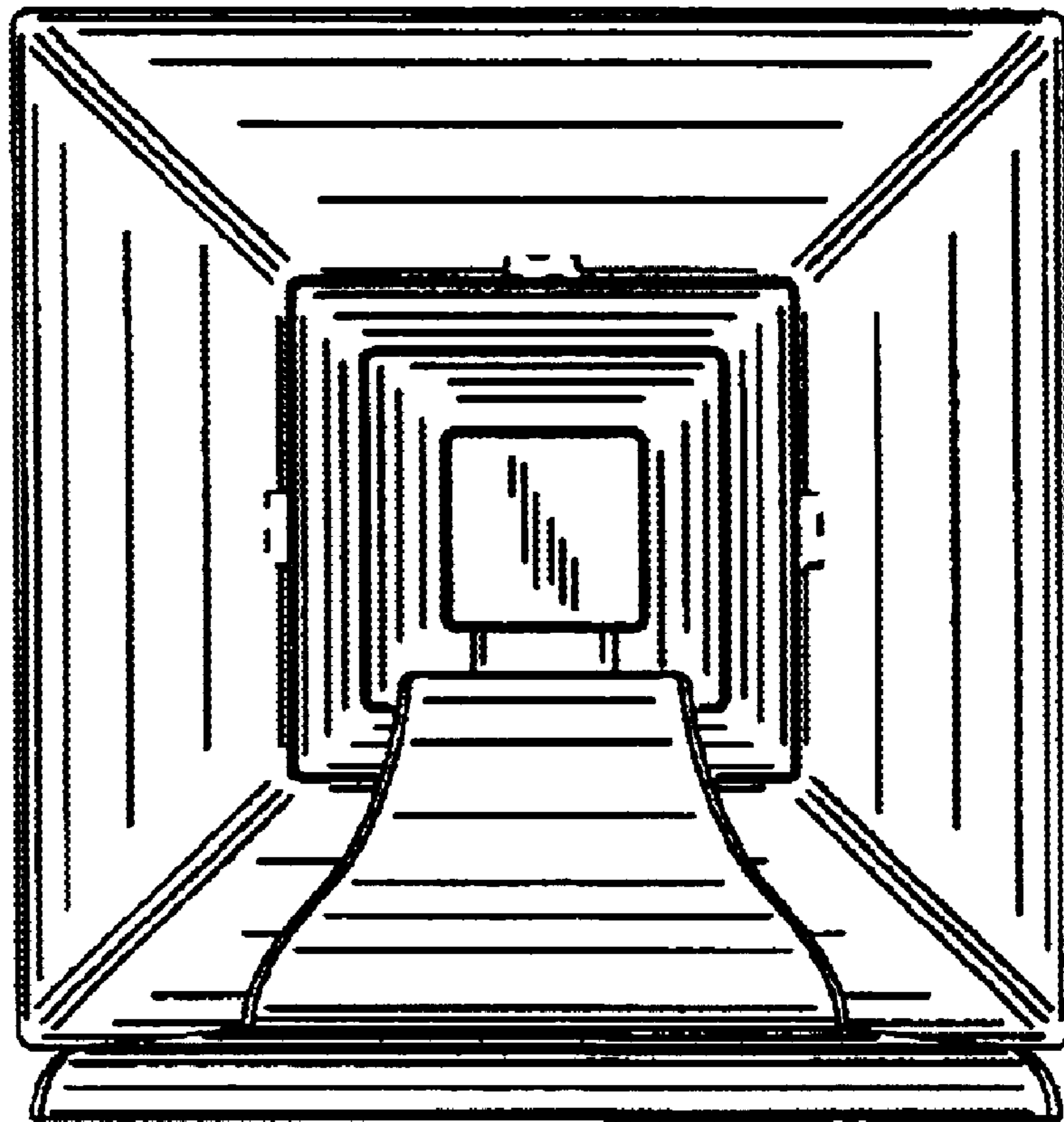

FIG. 4

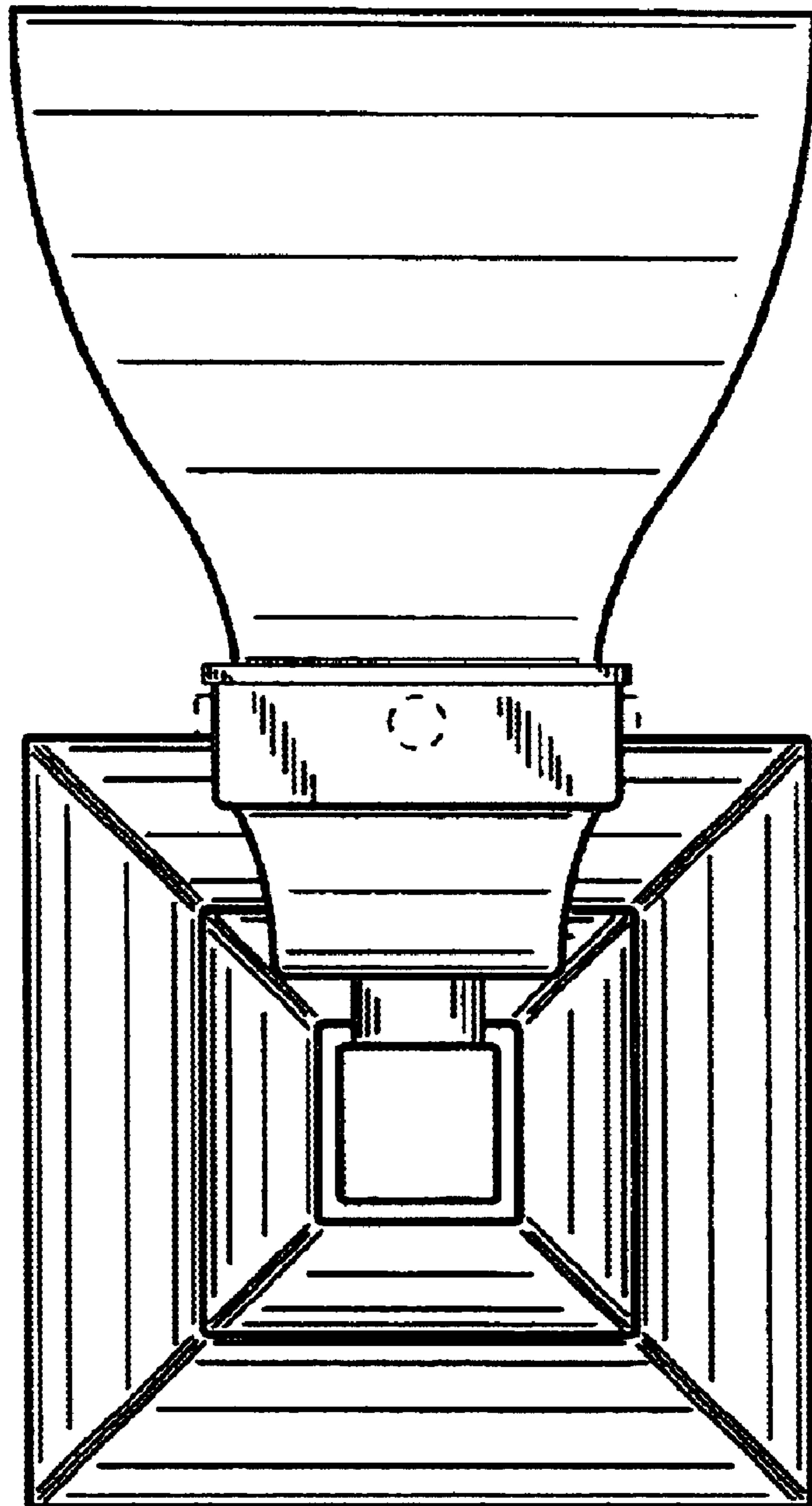

FIG. 5

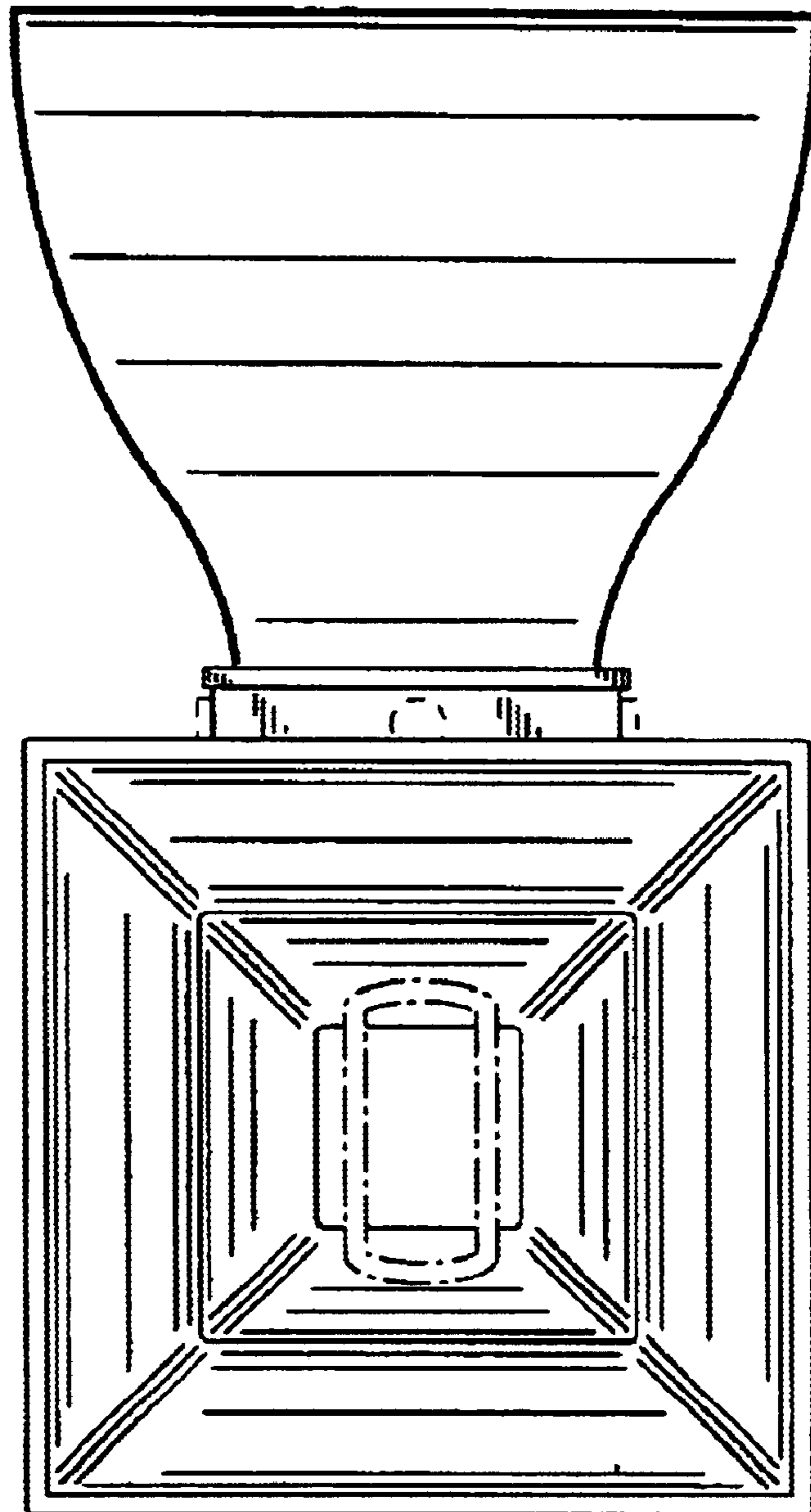

FIG. 6

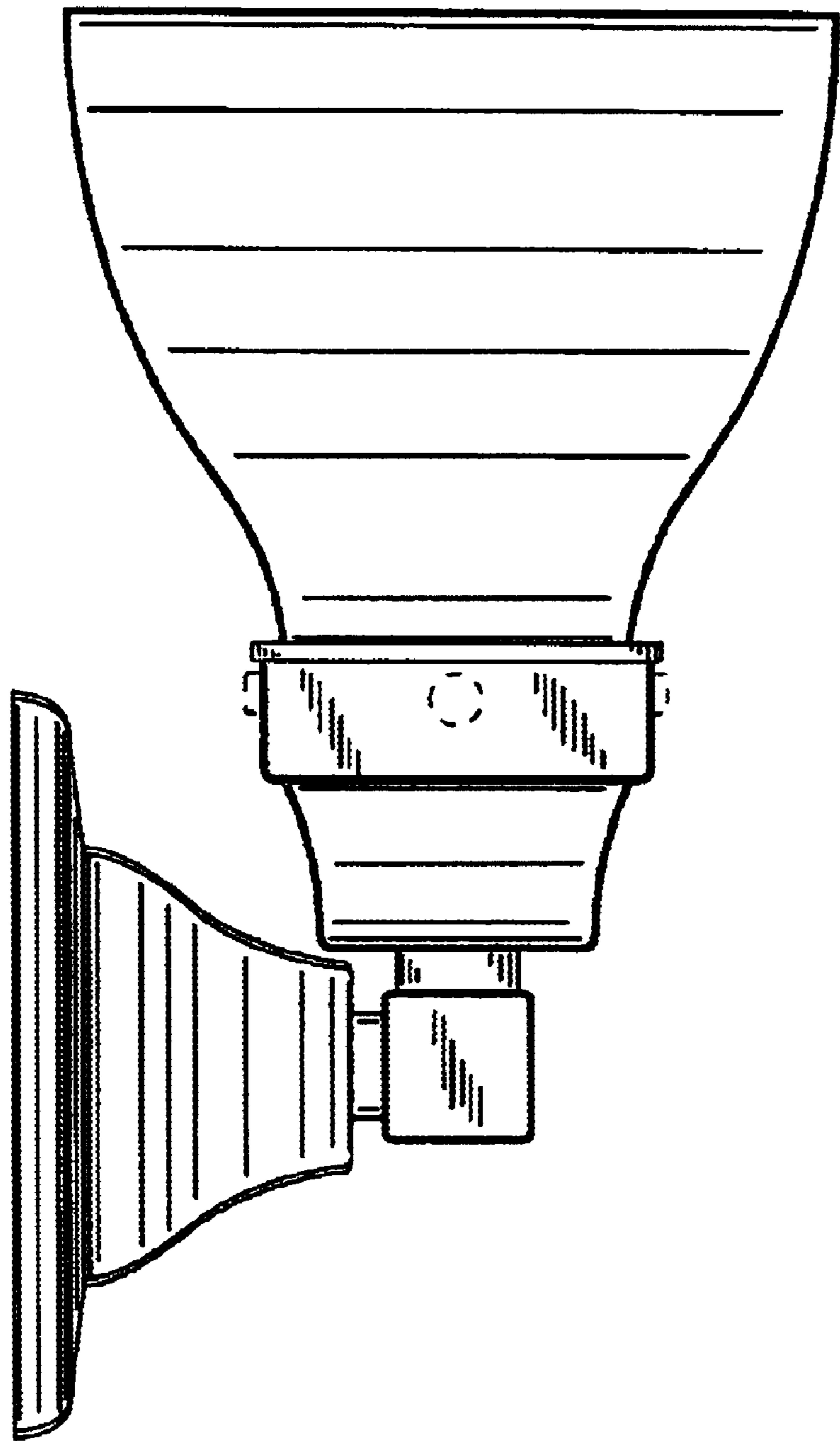

FIG. 7

