



US00D488540S

(12) **United States Design Patent**
Ouyoung

(10) **Patent No.:** **US D488,540 S**

(45) **Date of Patent:** **** Apr. 13, 2004**

(54) **FAUCET**

D461,879 S * 8/2002 Mullenmeister D23/257

(76) Inventor: **Scott Ouyoung**, c/o PMB#1008, 1867
Ygnacio Valley Rd., Walnut Creek, CA
(US) 94598-3214

* cited by examiner

Primary Examiner—Louis S. Zarfaz
Assistant Examiner—Gregory Andoll

(**) Term: **14 Years**

(57) **CLAIM**

(21) Appl. No.: **29/170,490**

The ornamental design for a faucet, as shown and described.

(22) Filed: **Nov. 7, 2002**

DESCRIPTION

(51) **LOC (7) Cl.** **23-01**

(52) **U.S. Cl.** **D23/255**

(58) **Field of Search** D23/238–243,
D23/250–257; 4/675–678; 137/801

FIG. 1 is perspective view of a faucet showing my new design;

FIG. 2 is a front side elevation view thereof;

FIG. 3 is a left side elevation view thereof;

FIG. 4 is a right side elevation view thereof;

FIG. 5 is a rear side elevation view thereof;

FIG. 6 is a top plan view thereof; and,

FIG. 7 is a bottom plan view thereof.

(56) **References Cited**

U.S. PATENT DOCUMENTS

D285,597 S * 9/1986 Miller et al. D23/242

D357,526 S * 4/1995 Jans D23/257

1 Claim, 4 Drawing Sheets

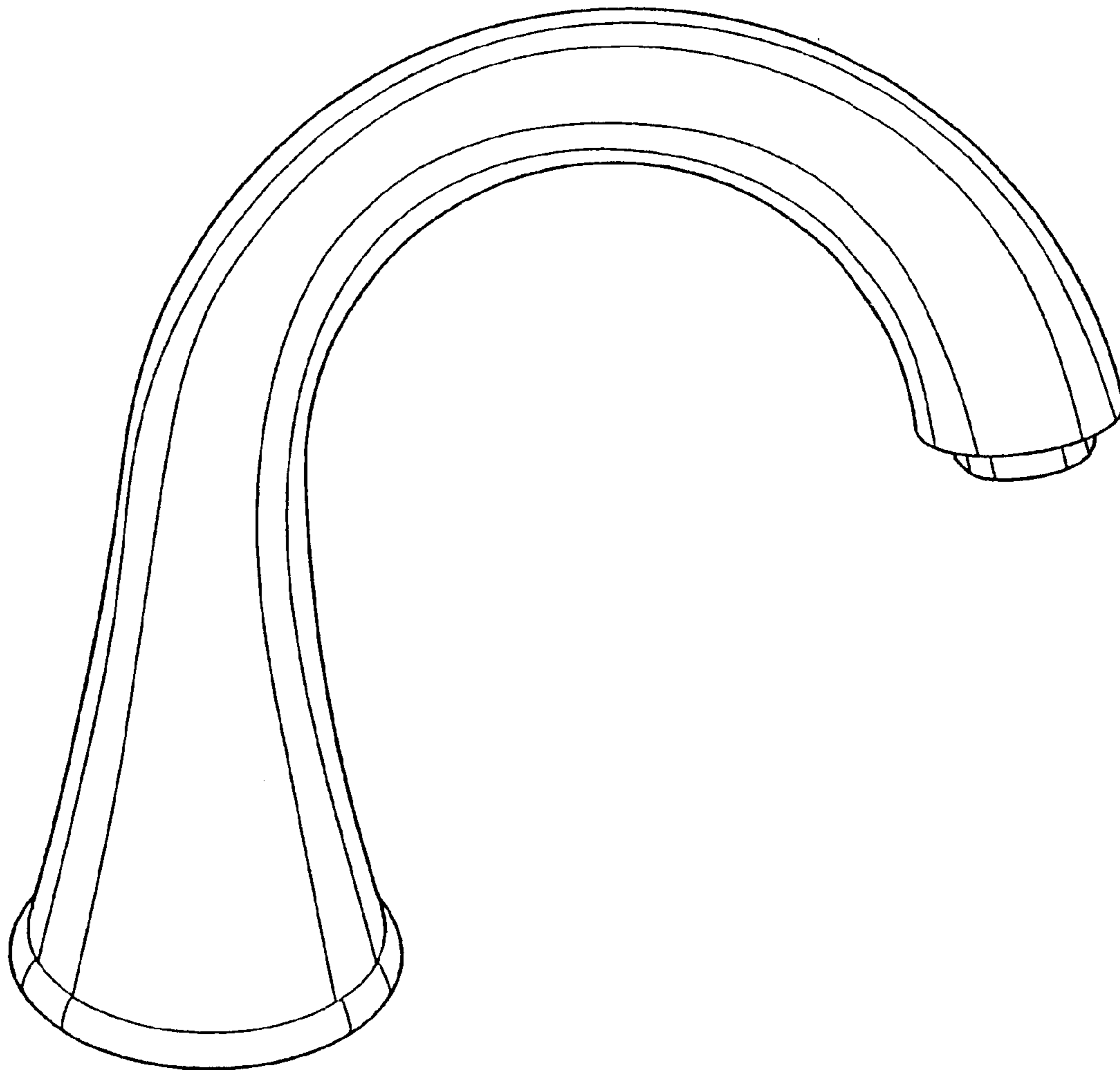

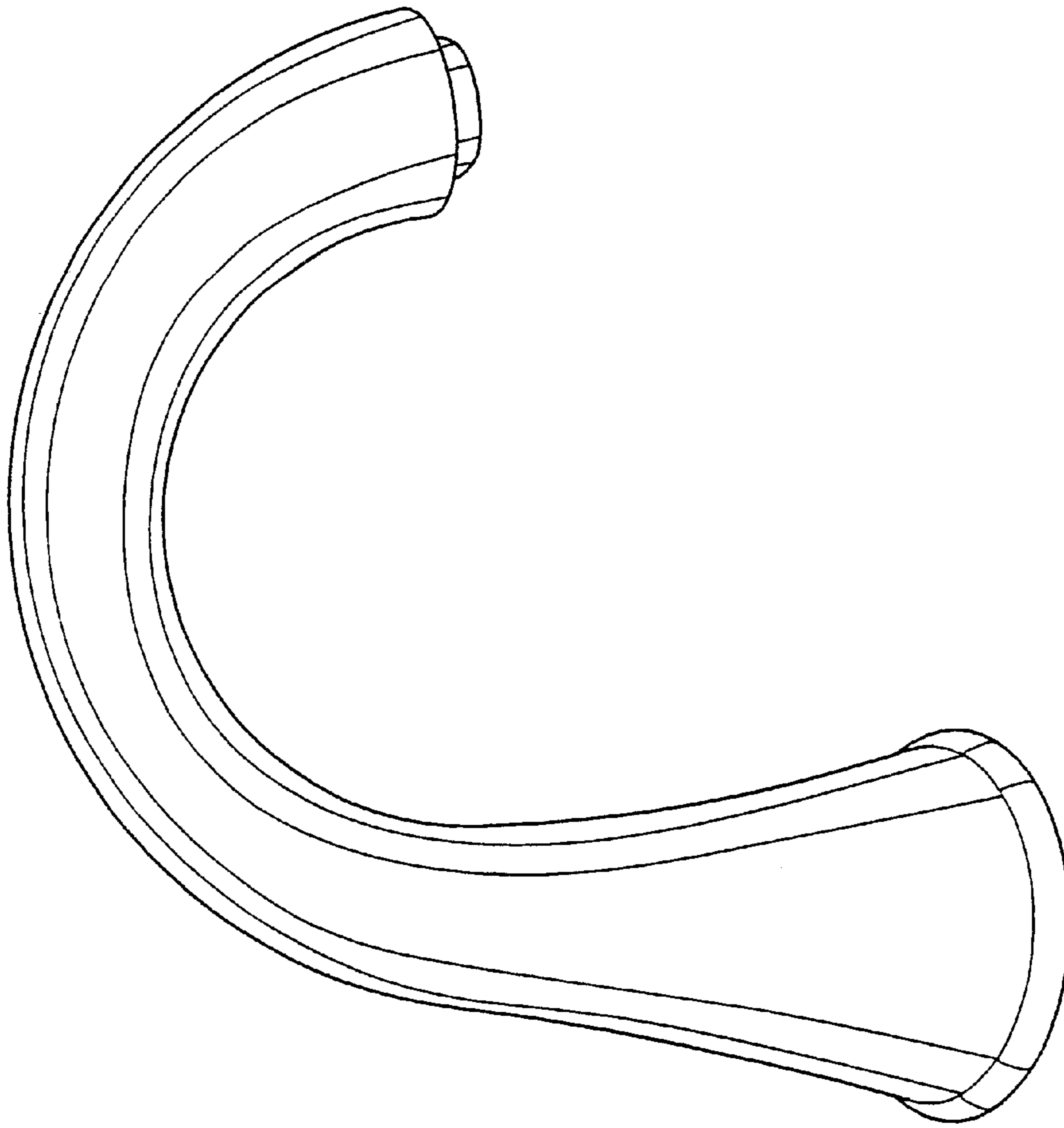

FIG. 1

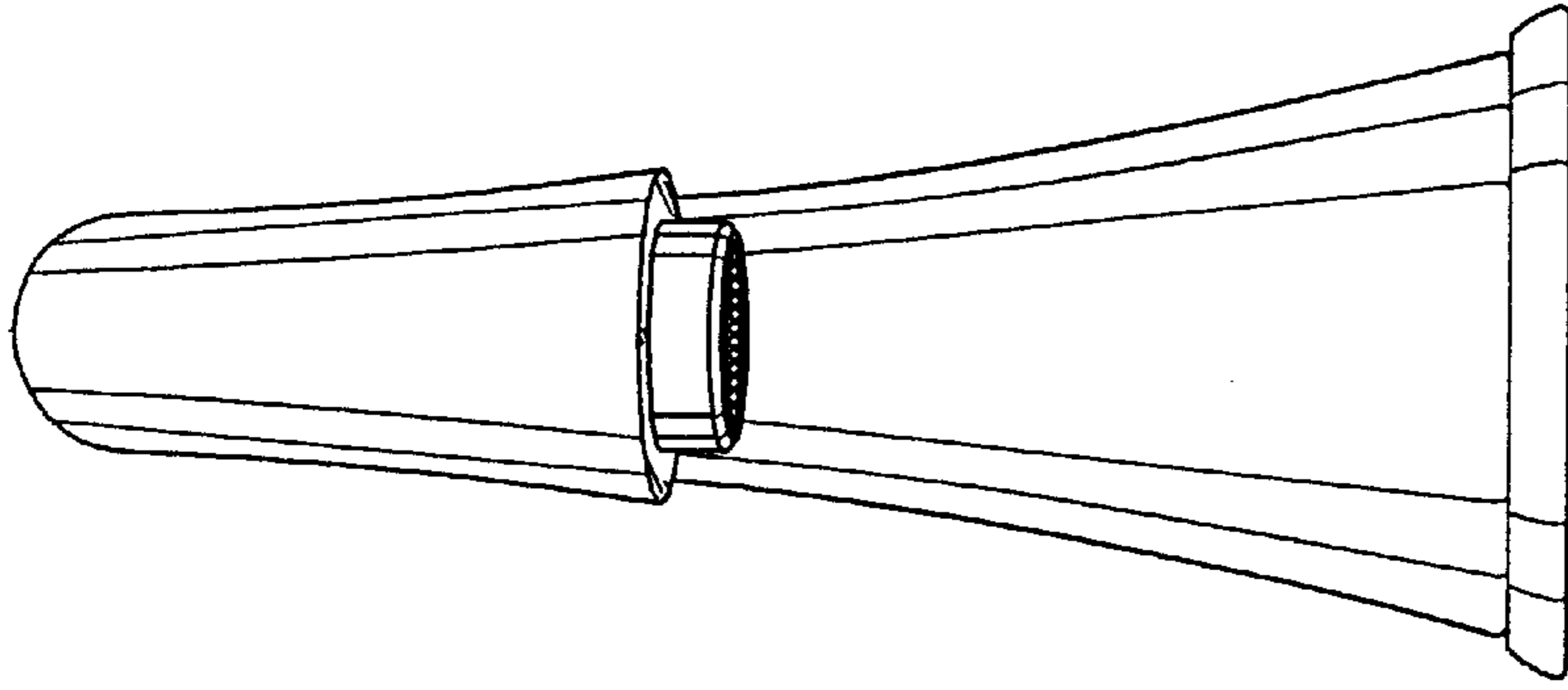

FIG. 2

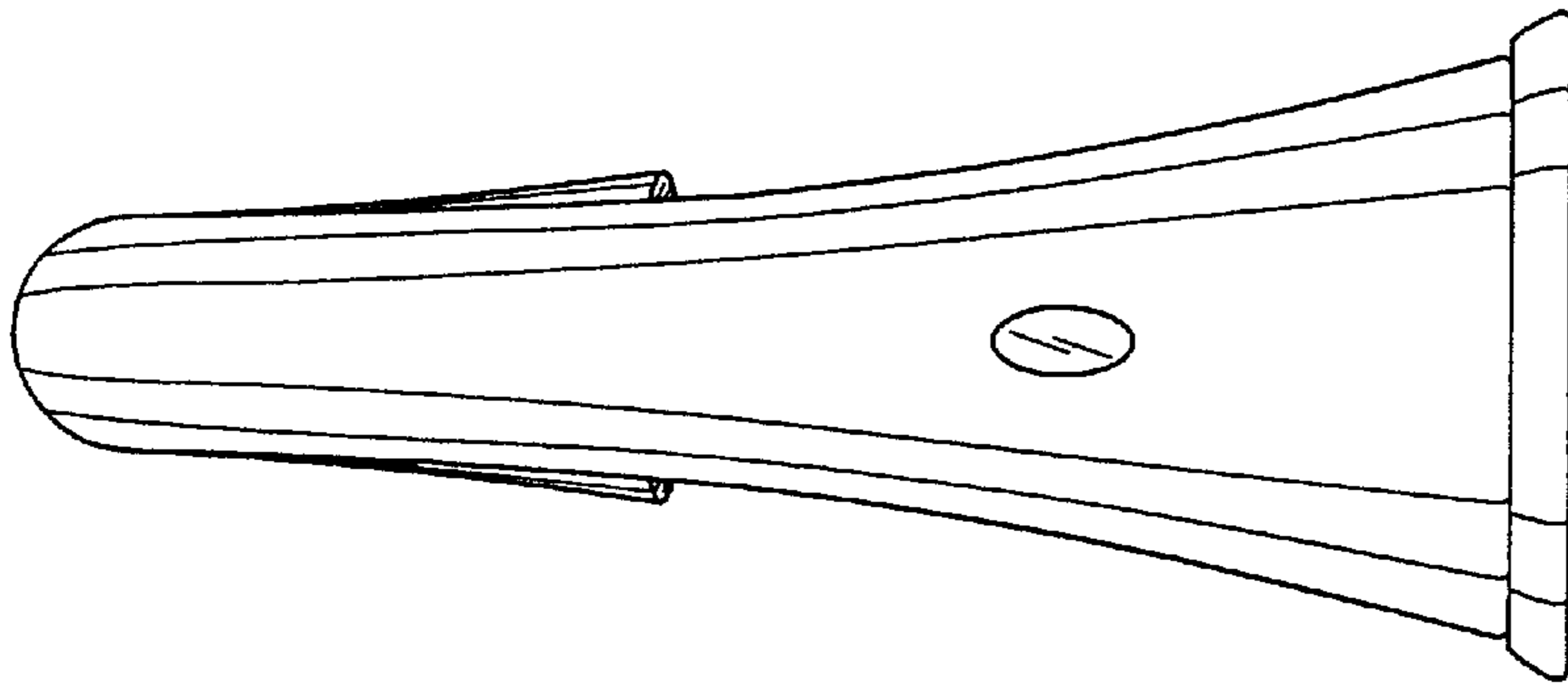

FIG. 5

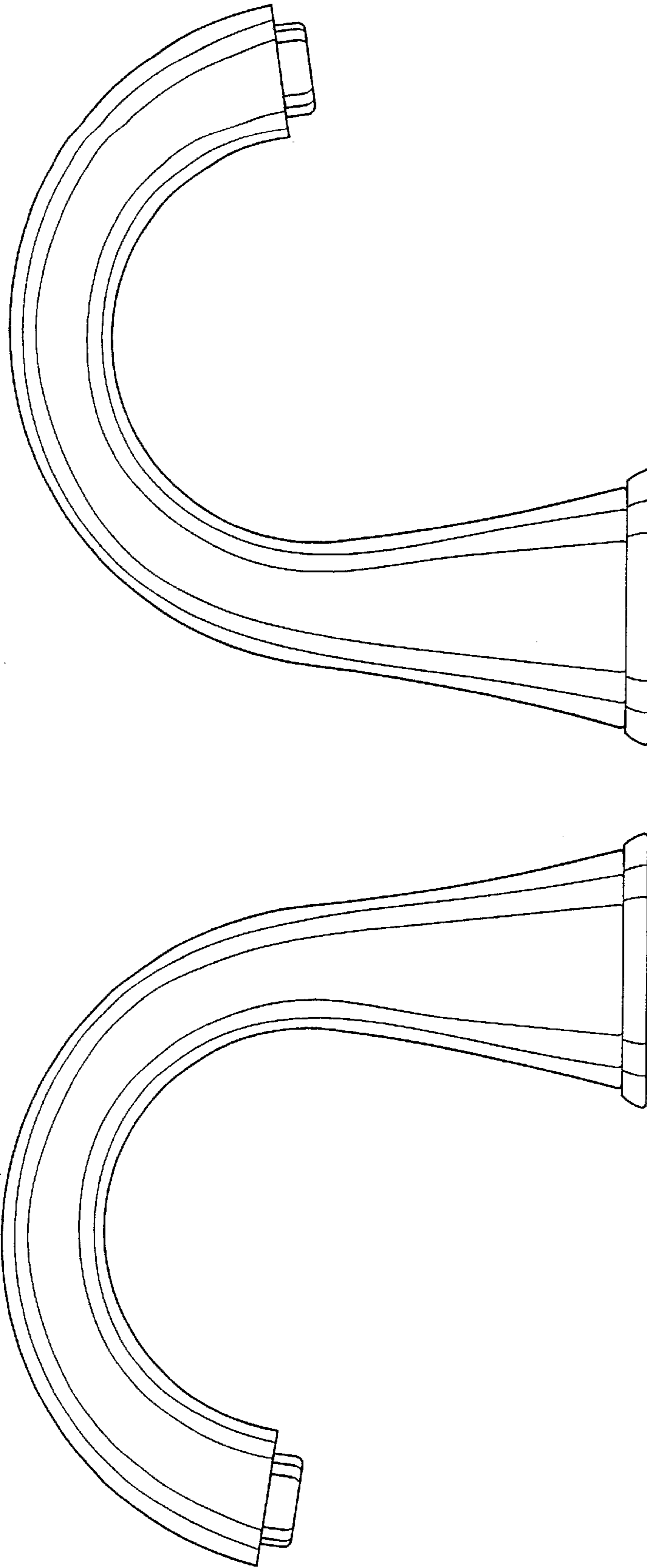

FIG. 3

FIG. 4

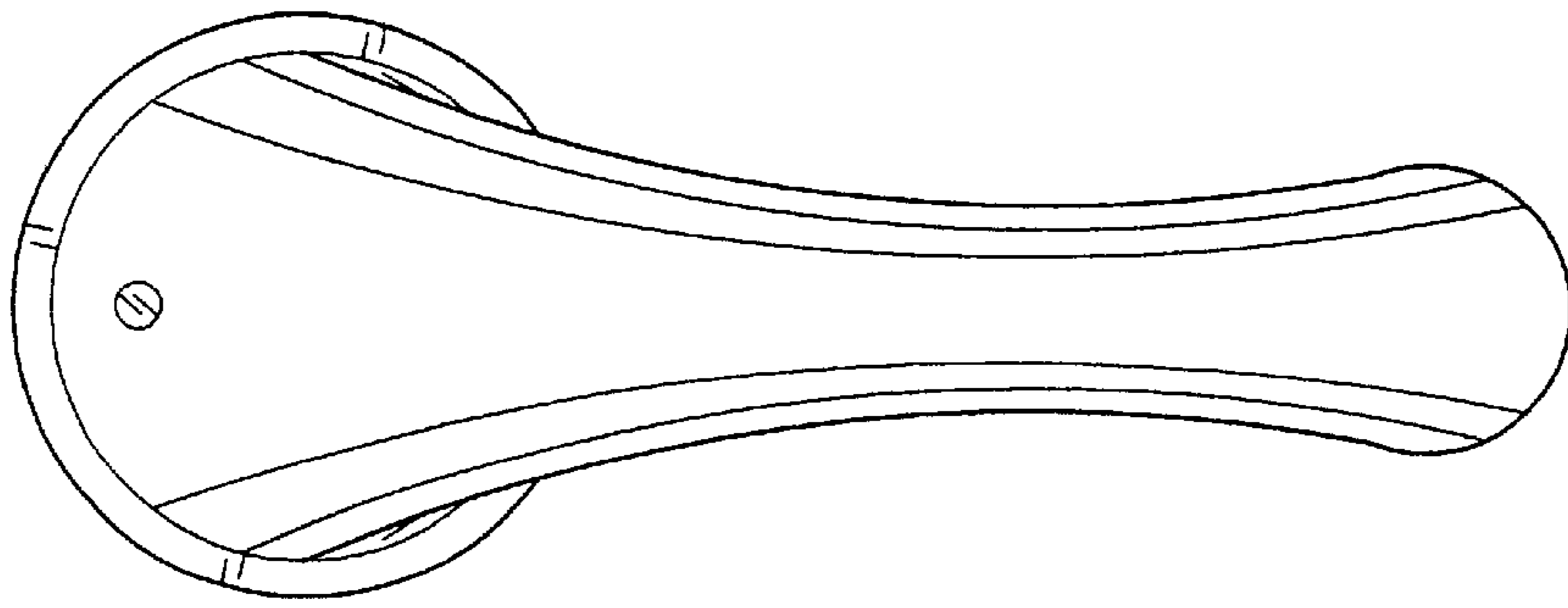

FIG. 6

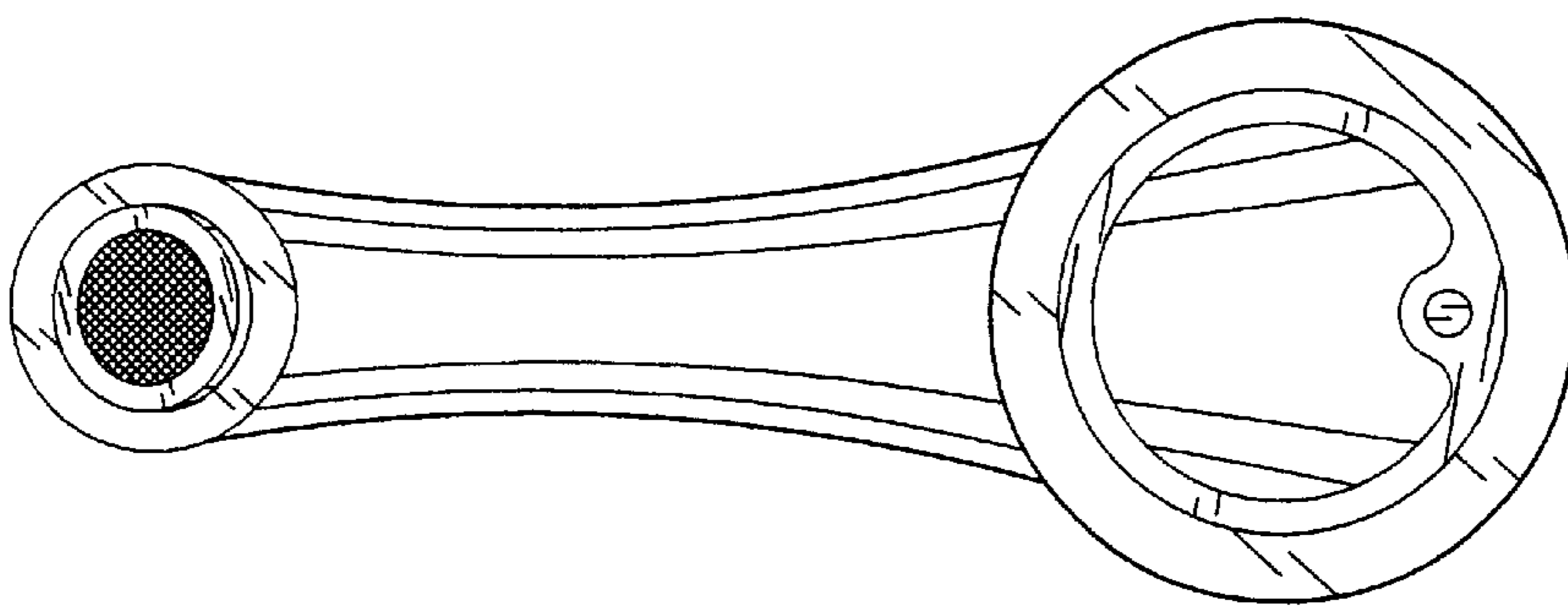

FIG. 7