



US00D488497S

(12) **United States Design Patent**  
**Suzuki**

(10) **Patent No.:** **US D488,497 S**

(45) **Date of Patent:** **\*\* Apr. 13, 2004**

(54) **CAMERA**

(75) Inventor: **Akio Suzuki**, Tokyo (JP)

(73) Assignee: **Sony Corporation**, Tokyo (JP)

(\*\*) Term: **14 Years**

(21) Appl. No.: **29/183,892**

(22) Filed: **Jun. 19, 2003**

(51) **LOC (7) Cl.** ..... **16-01**

(52) **U.S. Cl.** ..... **D16/218; D16/202**

(58) **Field of Search** ..... **D16/200–206,**  
**D16/208, 209, 218; 348/373–376; 358/909.1;**  
**396/535–541**

(56) **References Cited**

**U.S. PATENT DOCUMENTS**

D406,599 S	*	3/1999	Swayze et al.	.....	D16/202
D435,572 S		12/2000	Maeyama		
D442,203 S	*	5/2001	Suzuki et al.	.....	D16/202
D442,614 S	*	5/2001	Sumita	.....	D16/202
D445,438 S	*	7/2001	Kubota	.....	D16/202
D450,074 S		11/2001	Miyashita		

**OTHER PUBLICATIONS**

Web page “MVC–CD200” <http://support.d-imaging.sony.co.jp/contents/mvc-cd200/>, 1 sheet, Sony (Mar. 2003).

Web page “MVC–CK250 TOP” <http://www.sony.jp/products/Consumer/DSC/MVC-CD250/index.html>, 1 sheet, Sony (Mar. 2003).

Web page “MVC–FD200 TOP” <http://www.sony.jp/products/Consumer/DSC/MVC-FD200/index.html>, 1 sheet, Sony (Mar. 2003).

\* cited by examiner

*Primary Examiner*—Adir Aronovich

(74) *Attorney, Agent, or Firm*—Rader, Fishman & Grauer PLLC

(57) **CLAIM**

The ornamental design for a camera, as shown.

**DESCRIPTION**

FIG. 1 is a perspective view of a camera showing my new design;

FIG. 2 is a front elevational view thereof;

FIG. 3 is a rear elevational view thereof;

FIG. 4 is a left side elevational view thereof;

FIG. 5 is a right side elevational view thereof;

FIG. 6 is a top plan view thereof; and,

FIG. 7 is a bottom plan view thereof.

**1 Claim, 4 Drawing Sheets**

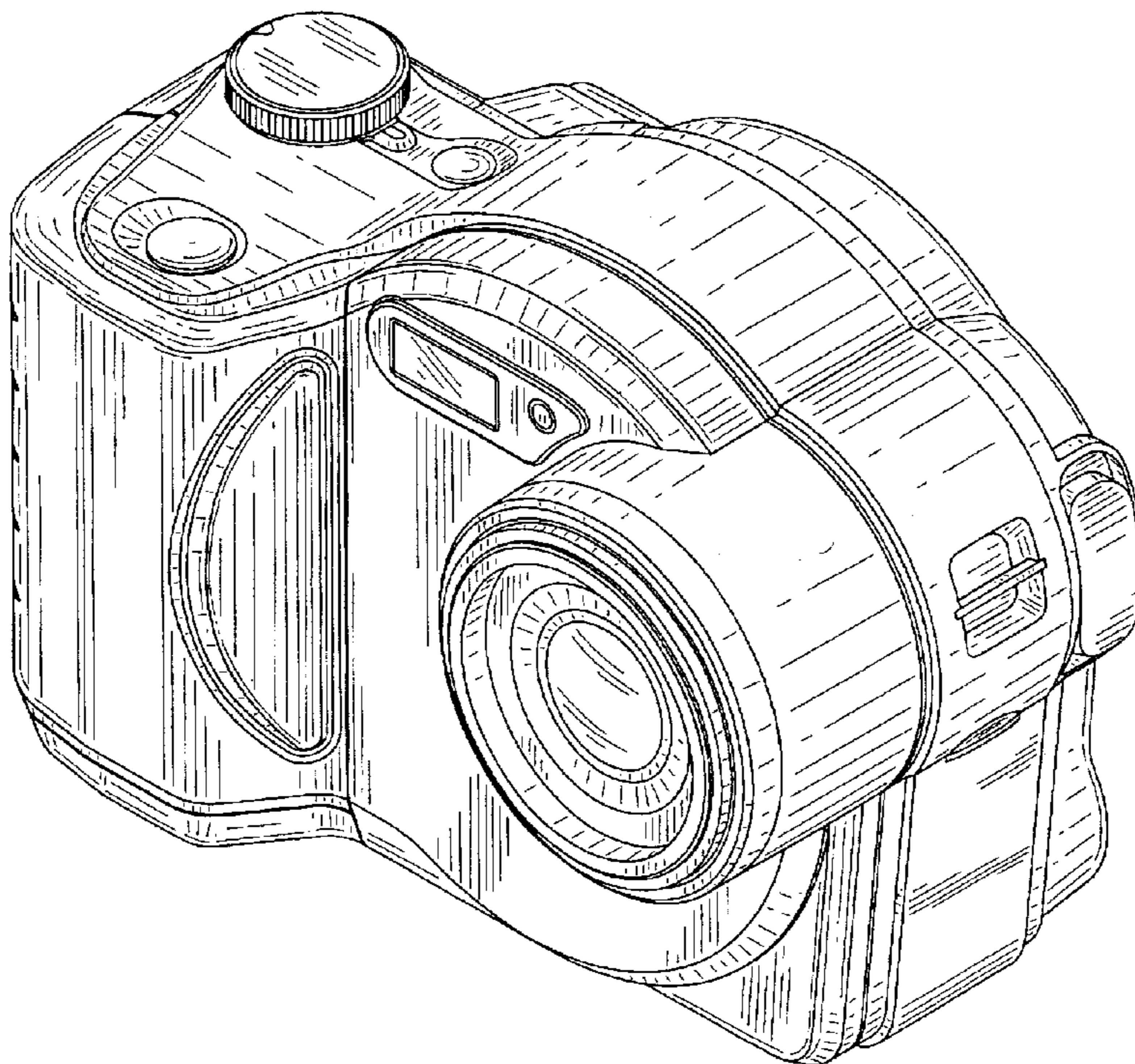

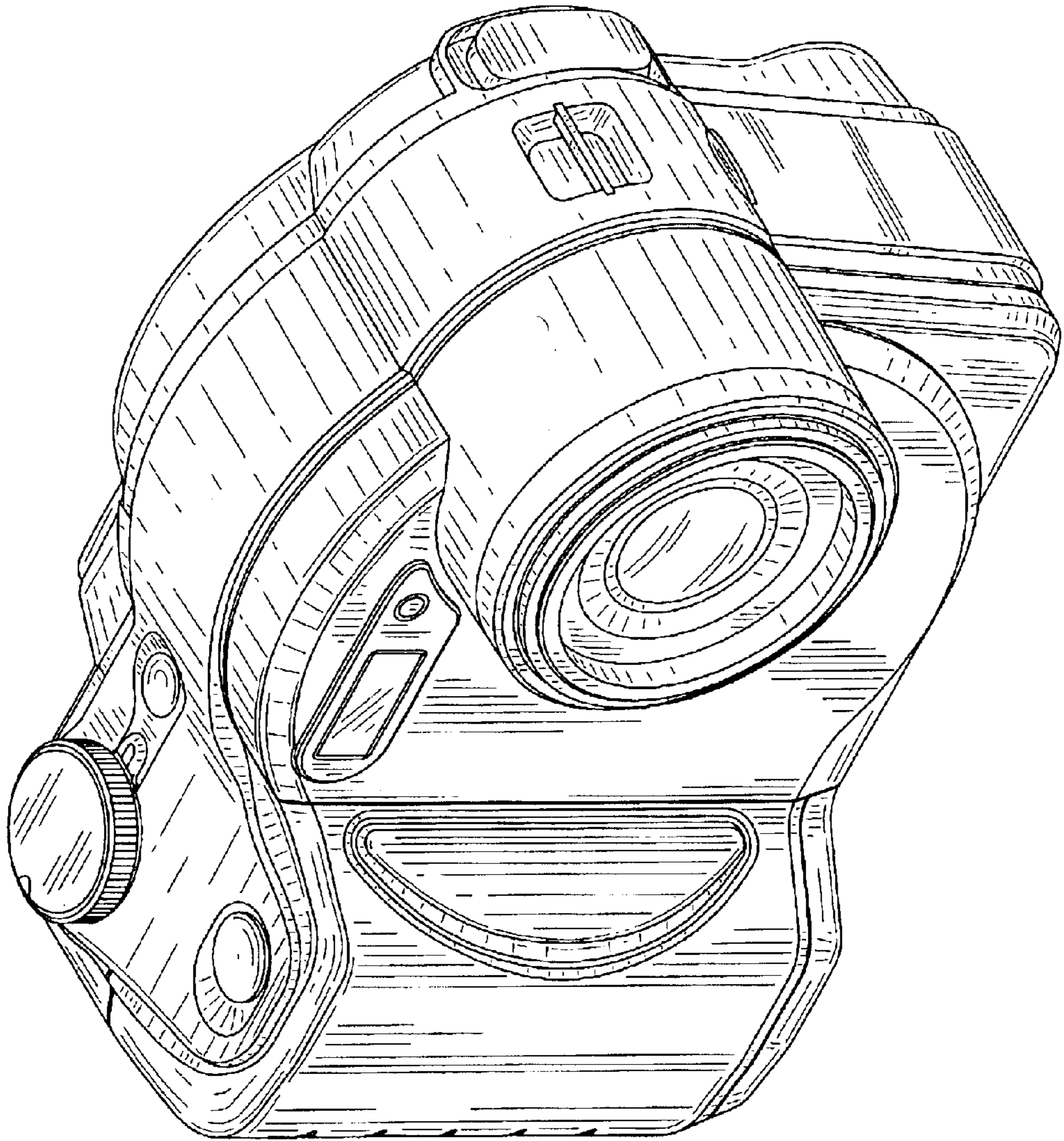

FIG.1

FIG.2

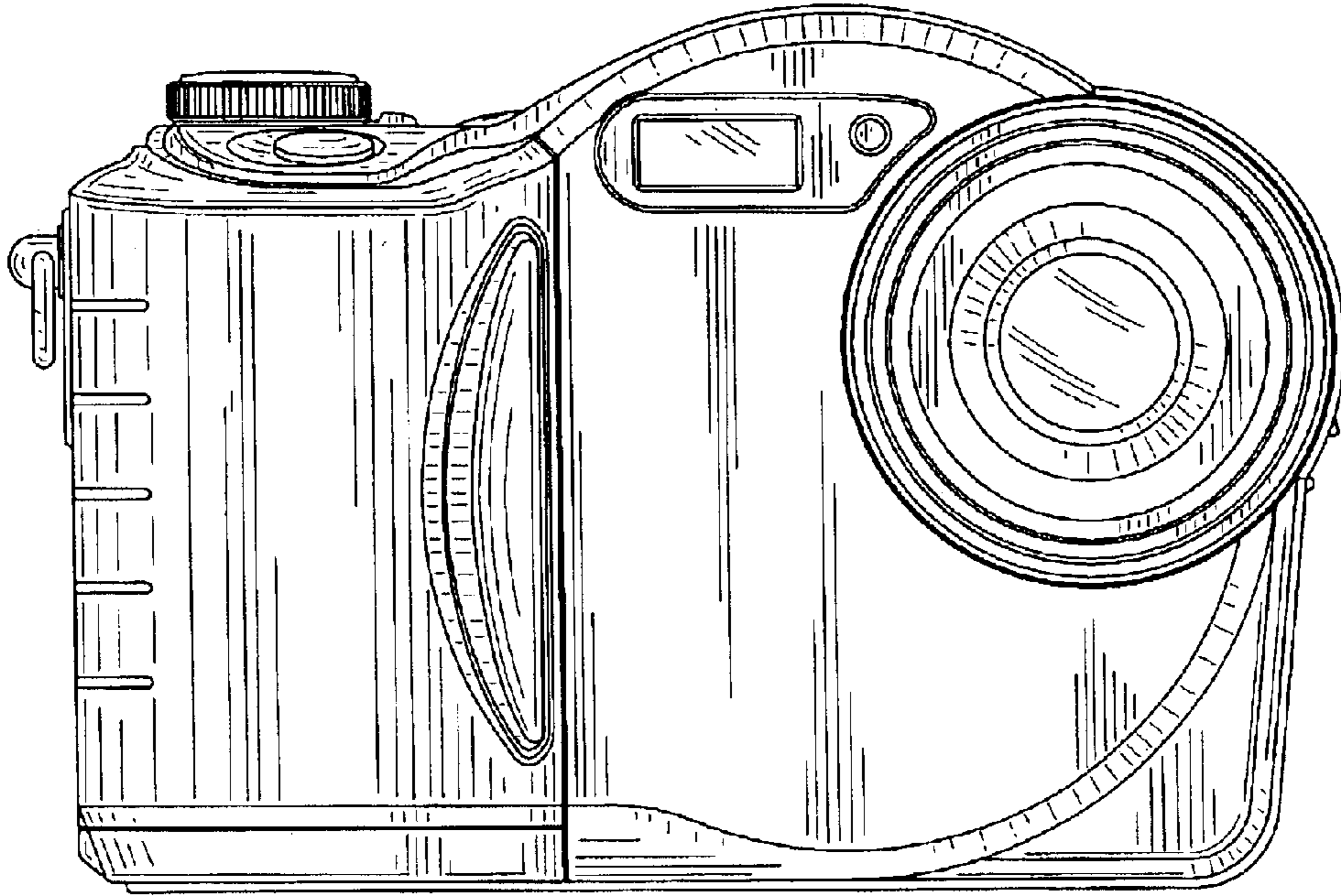

FIG.3

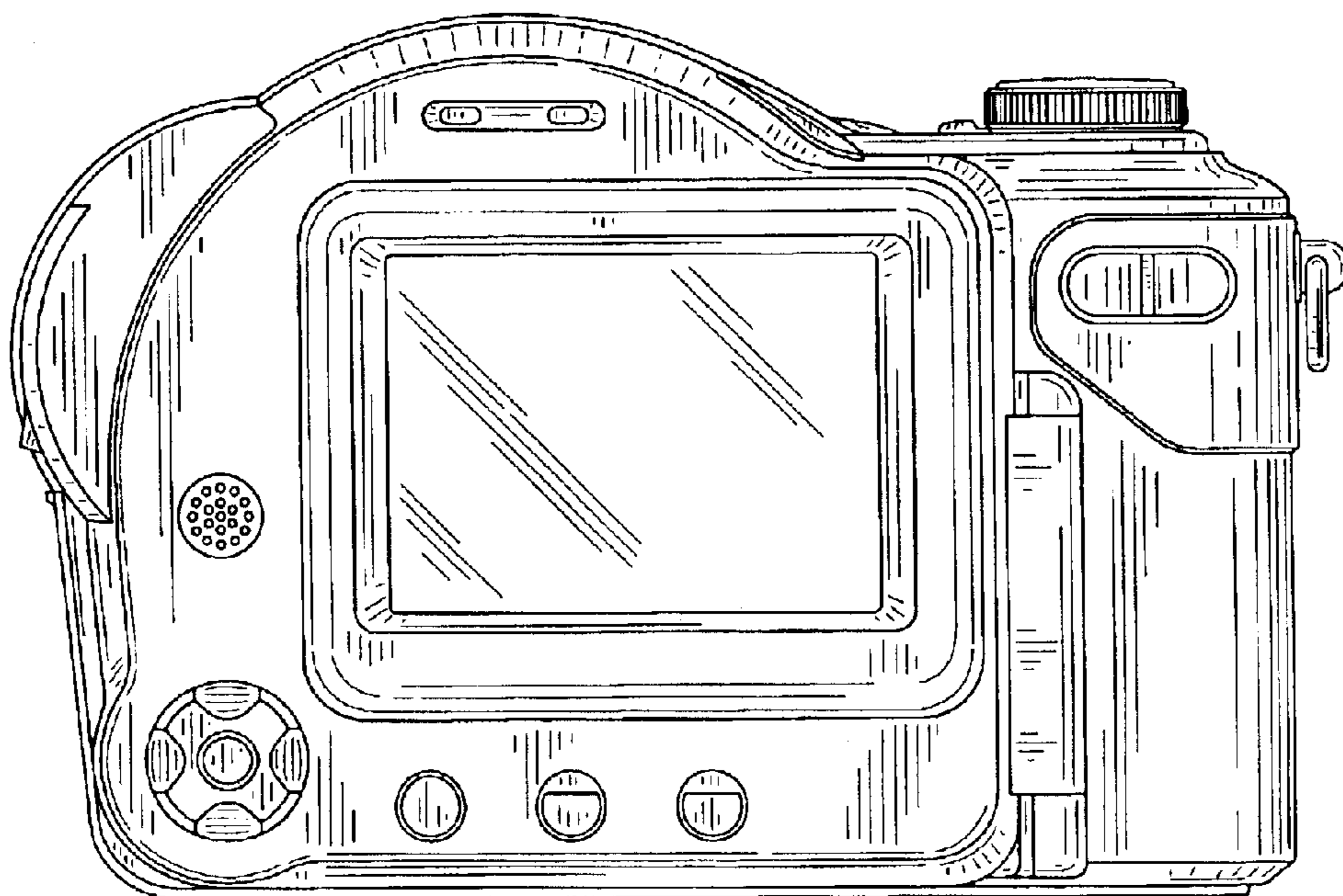

FIG. 4

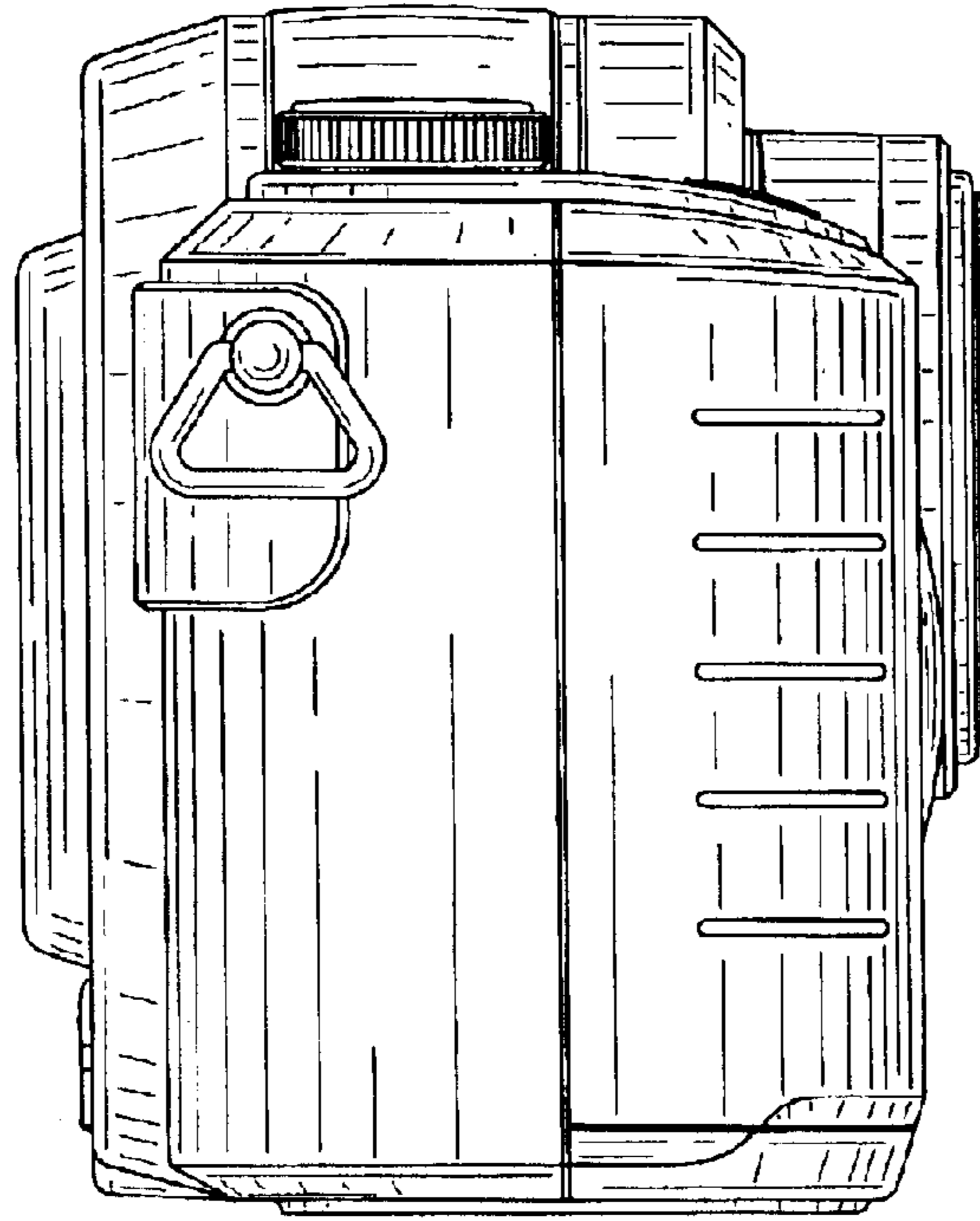

FIG. 5

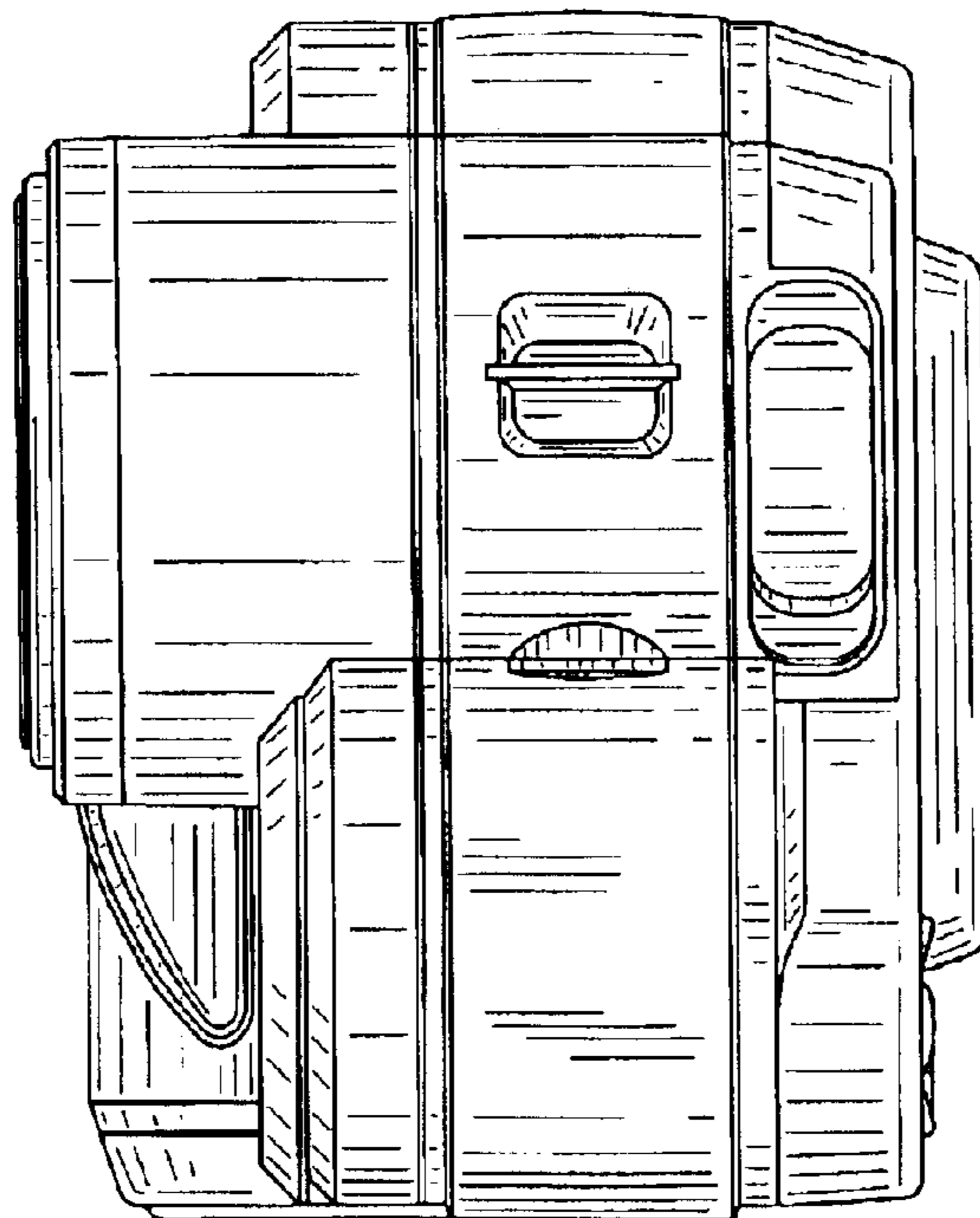

FIG.6

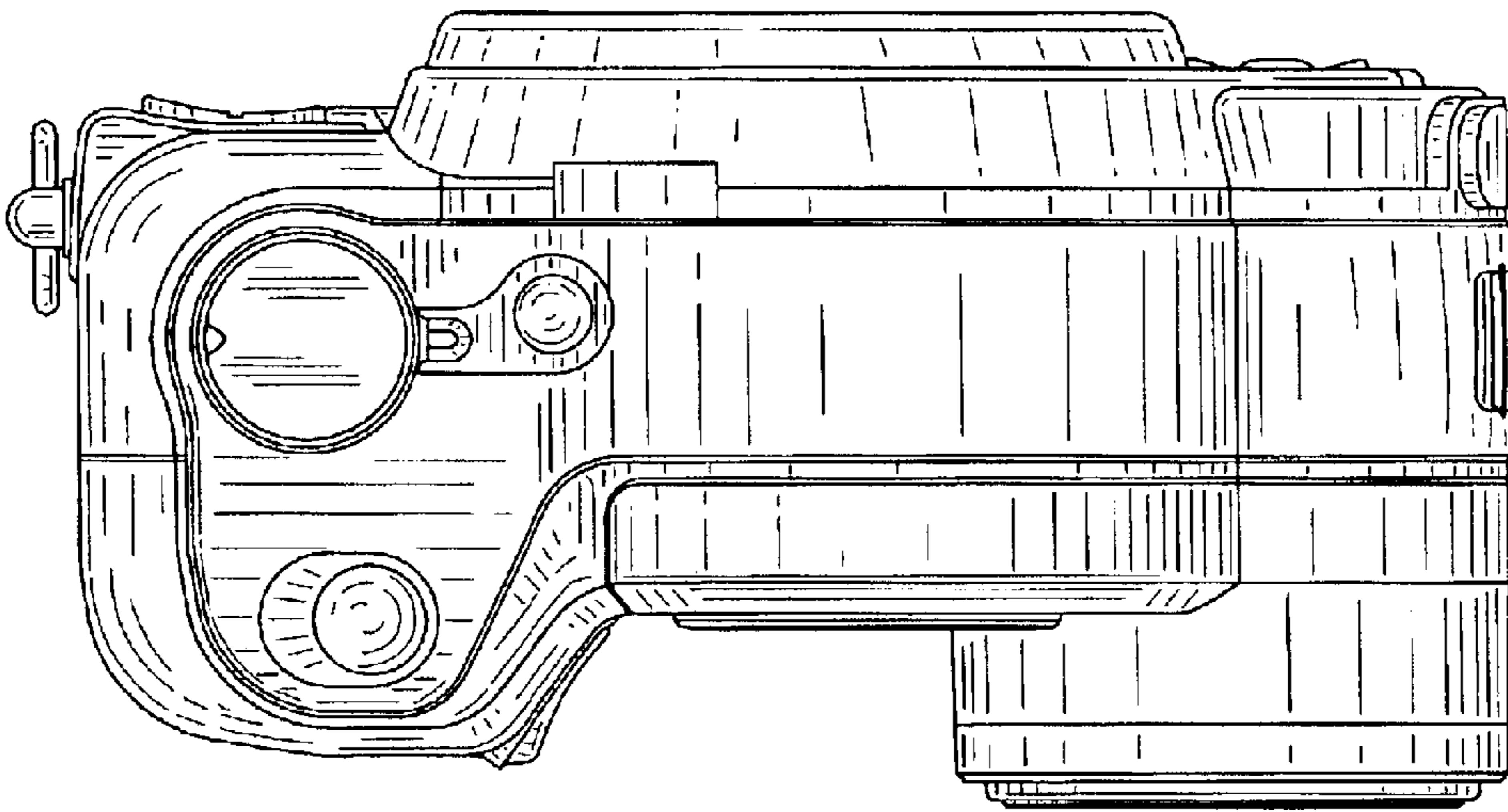

FIG.7

