



US00D488460S

(12) **United States Design Patent**
Alwicker et al.

(10) **Patent No.:** **US D488,460 S**
(45) **Date of Patent:** **** Apr. 13, 2004**

(54) **EARPHONE**

(75) Inventors: **Michael Joseph Alwicker**, Evanston, IL (US); **Ronald John Vish**, West Roxbury, MA (US)

(73) Assignee: **Shure Incorporated**, Evanston, IL (US)

(**) Term: **14 Years**

(21) Appl. No.: **29/172,254**

(22) Filed: **Dec. 9, 2002**

(51) **LOC (7) Cl.** **14-01**

(52) **U.S. Cl.** **D14/223**

(58) **Field of Search** D14/192, 205, D14/206, 223, 228, 248; 181/128-130; 379/430, 431; 381/374, 376, 377, 378, 379, 381; D24/106, 134; 128/864, 866

(56) **References Cited**

U.S. PATENT DOCUMENTS

2,325,590	A	*	8/1943	Carlisle et al.	381/328
3,085,253	A	*	4/1963	Ulrich et al.	2/209
4,671,265	A	*	6/1987	Andersson	128/866
D291,197	S	*	8/1987	LaLanne	D14/205
D324,523	S	*	3/1992	Hughes et al.	D14/205
D336,299	S	*	6/1993	Darovic	D14/205
6,006,361	A	*	12/1999	Falco et al.	2/209
D463,552	S	*	9/2002	Werblud	D24/134

OTHER PUBLICATIONS

- <http://www.etymotic.com/musicians/er6more.html>.
- http://www.etymotic.com/product_list/product_summary.asp?product_numberER-6.
- <http://www.etymotic.com/musicians/er4more.html>.
- http://www.etymotic.com/product_list/product_list_summary.asp?product_numberER-4P.
- <http://www.koss.com/koss/kossweb.nsf/02ProductPrint/THEPLUG?OpenDocument>.
- <http://www.koss.com/koss/kossweb.nsf/02ProductPrint/KSC19?OpenDocument>.
- <http://www.koss.com/koss/kossweb.nsf/02ProductPrint/P4?OpenDocument>.

<http://www.koss.com/koss/kossweb.nsf/02ProductPrint/StereoBudz?OpenDocument>.

http://www.jp.aiwa.com/corporate/report/2002_e/hp-vx100e.html.

http://www.sonystyle.com/is-bin/INTERSHOP.enfinity/eCS/Store/en/-USD/SY_BrowseCatalog-Start;sid=LqEG2KngZJgG05b4.

<http://www.sel.sony.com/SEL/consumer/ss5/portable/accessories/fontopiartmear-budhead...>

Westone Music Products, The In-Ear Experts, Elite Series Brochure.

<http://www.westone.com/music/elite.html>.

<http://www.earmold.com/music/universal.html>.

(List continued on next page.)

Primary Examiner—Paula A. Mortimer

(74) *Attorney, Agent, or Firm*—Banner & Witcoff, Ltd.

(57) **CLAIM**

An ornamental design for an earphone, as shown and described.

DESCRIPTION

FIG. 1 is an isometric view of the earphone design; FIG. 2 is a right side view of the right earphone earpiece; the left earphone earpiece is a mirror image of the right earpiece; FIG. 3 is a rear view of the right earphone earpiece; the left earphone earpiece is a mirror image of the right earpiece; FIG. 4 is a left side view of the right earphone earpiece; the left earphone earpiece is a mirror image of the right earpiece; FIG. 5 is a top view of the right earphone earpiece; the left earphone earpiece is a mirror image of the right earpiece; FIG. 6 is a front view of the right earphone earpiece; the left earphone earpiece is a mirror image of the right earpiece; and, FIG. 7 is a bottom view of the right earphone earpiece; the left earphone earpiece is a mirror image of the right earpiece. The broken lines are for illustrative purposes only and forms no part of the claimed design.

1 Claim, 2 Drawing Sheets

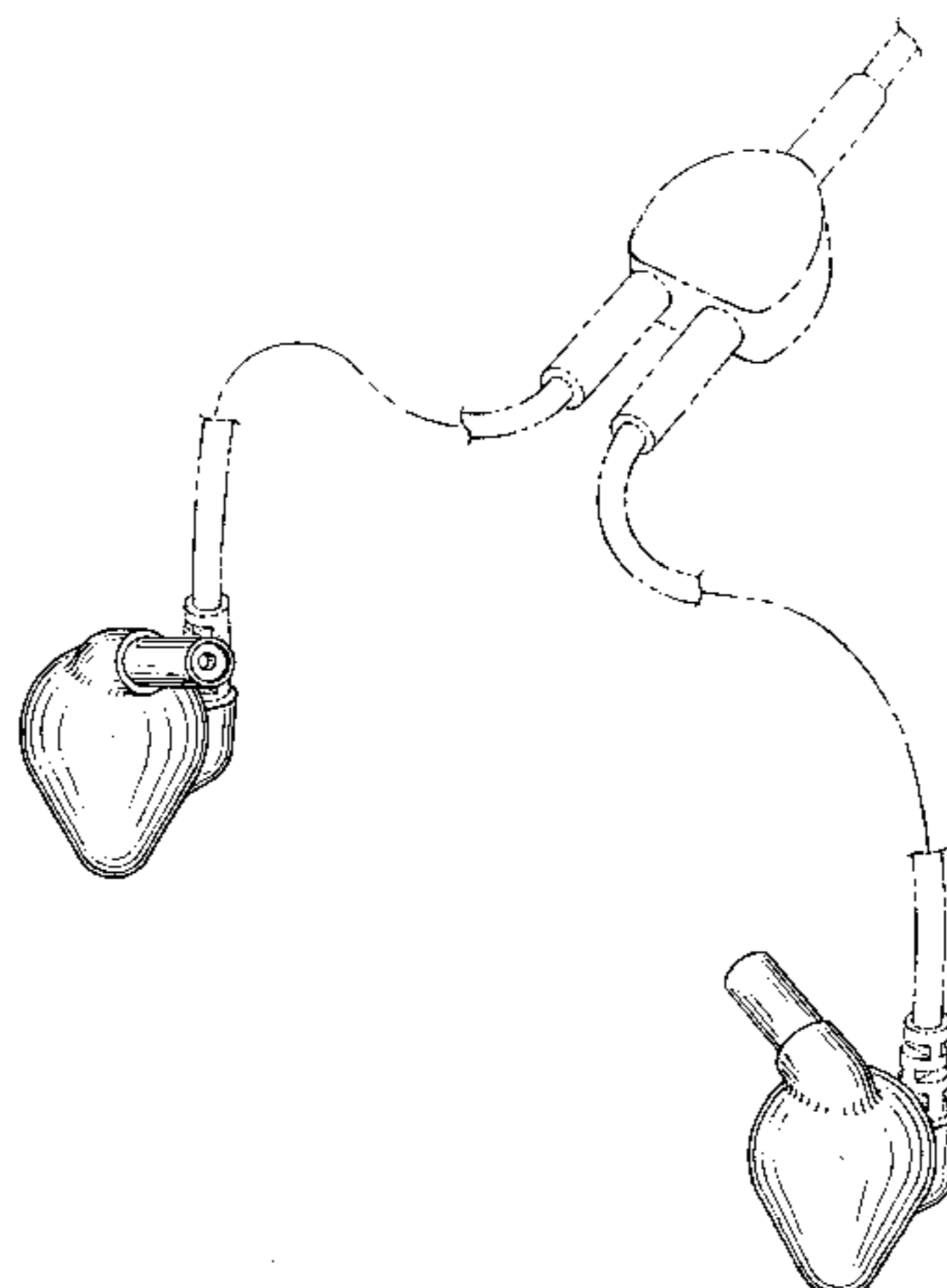

OTHER PUBLICATIONS

Westone Music Products, The In-Ear Experts, Universal Series Brochure.

<http://www.westone.com/music/universal.html>.

Sennheiser 2003 General Catalog, p. 6.

<http://www.sennheiserusa.com/pages/products/headphones/mx.htm>.

Jabra Corporation FreeSpeak BT200 Brochures.

http://www.jabra.com/products/FreeSpeak_Bluetooth.htm.

Future Sonics Incorporated, Ear Monitors Product Data Sheet, Oct. 2001.

<http://www.futuresonics.com/html/products.html>.

* cited by examiner

FIG. 1

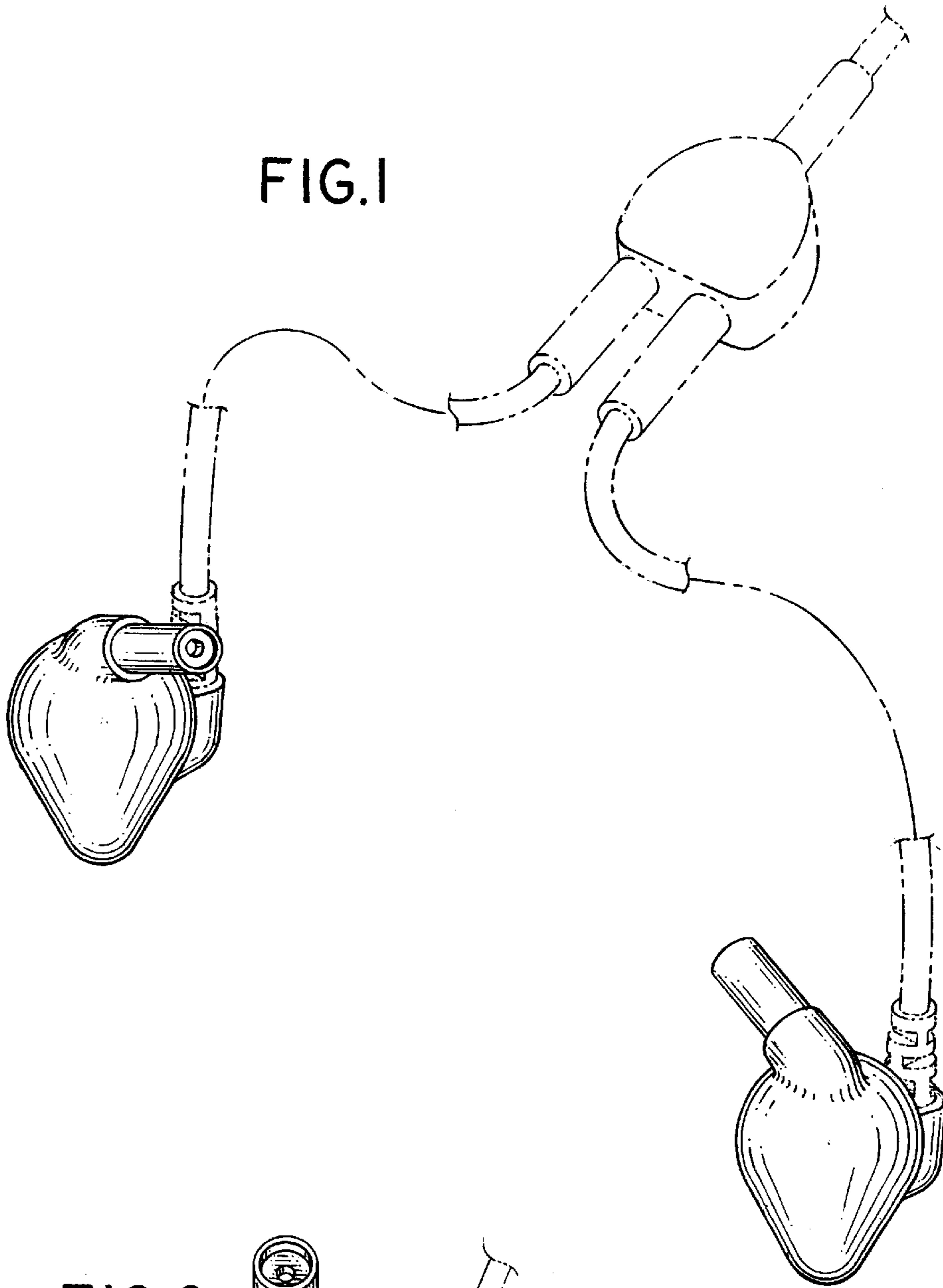

FIG. 2

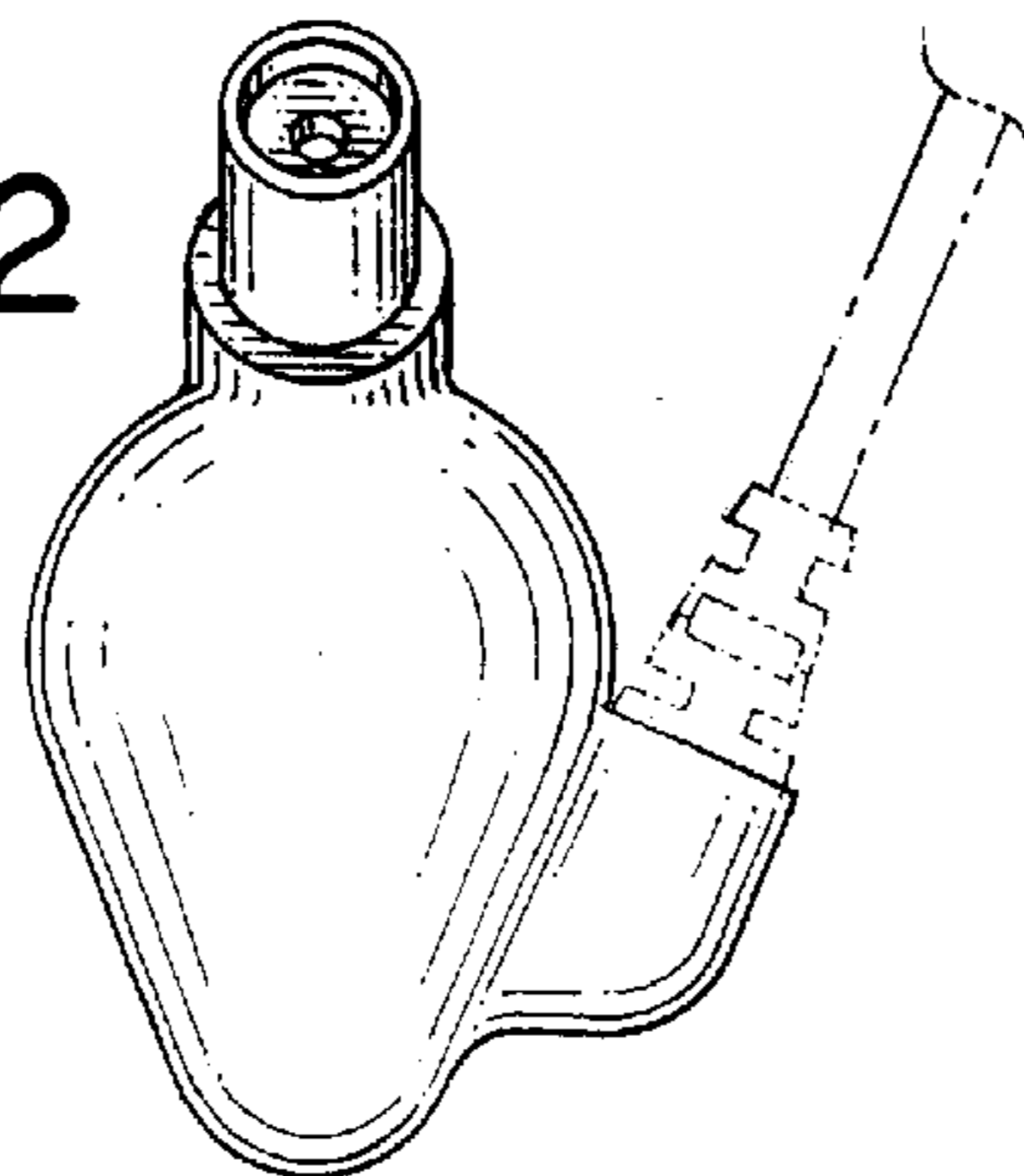

FIG.3

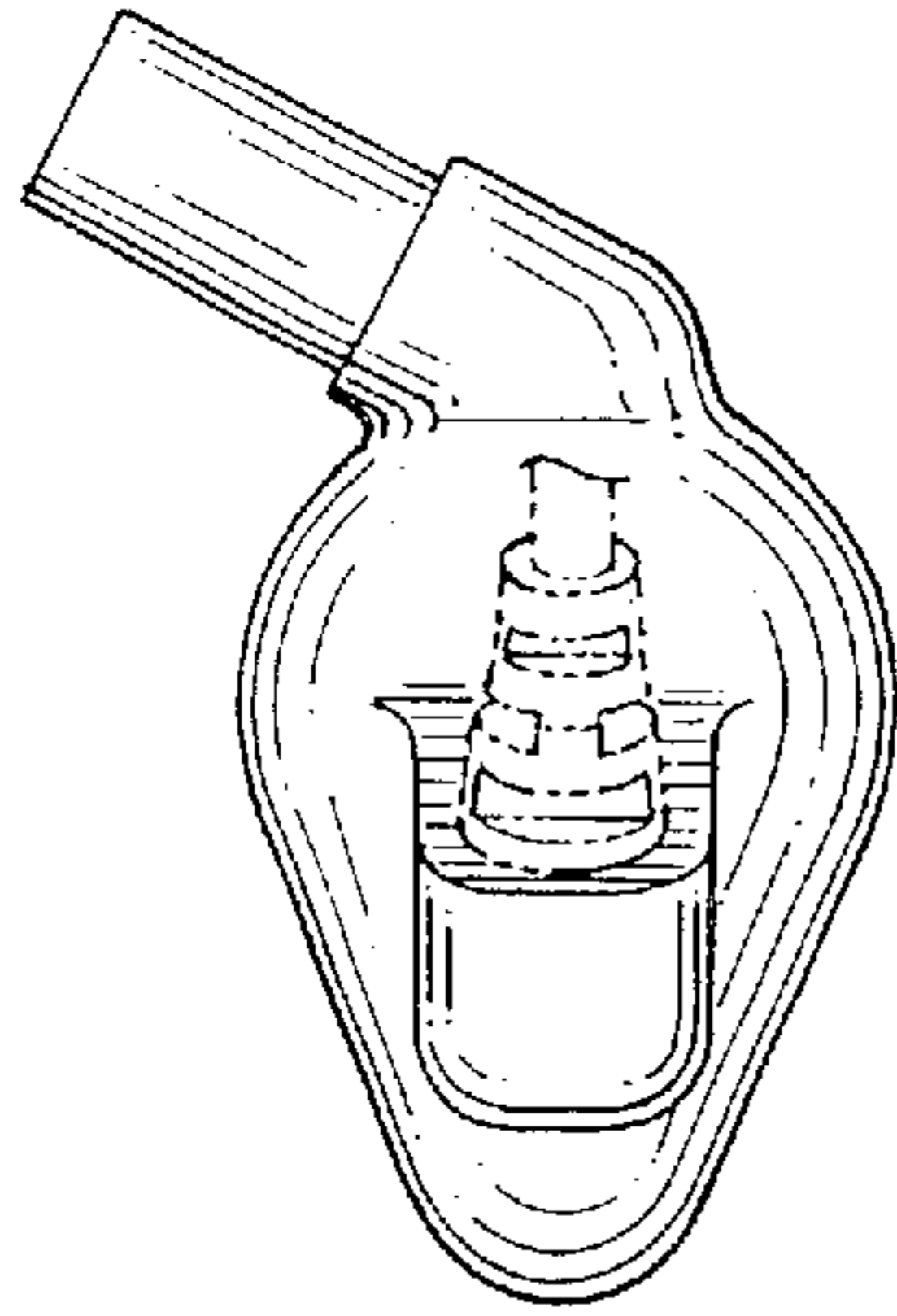

FIG.4

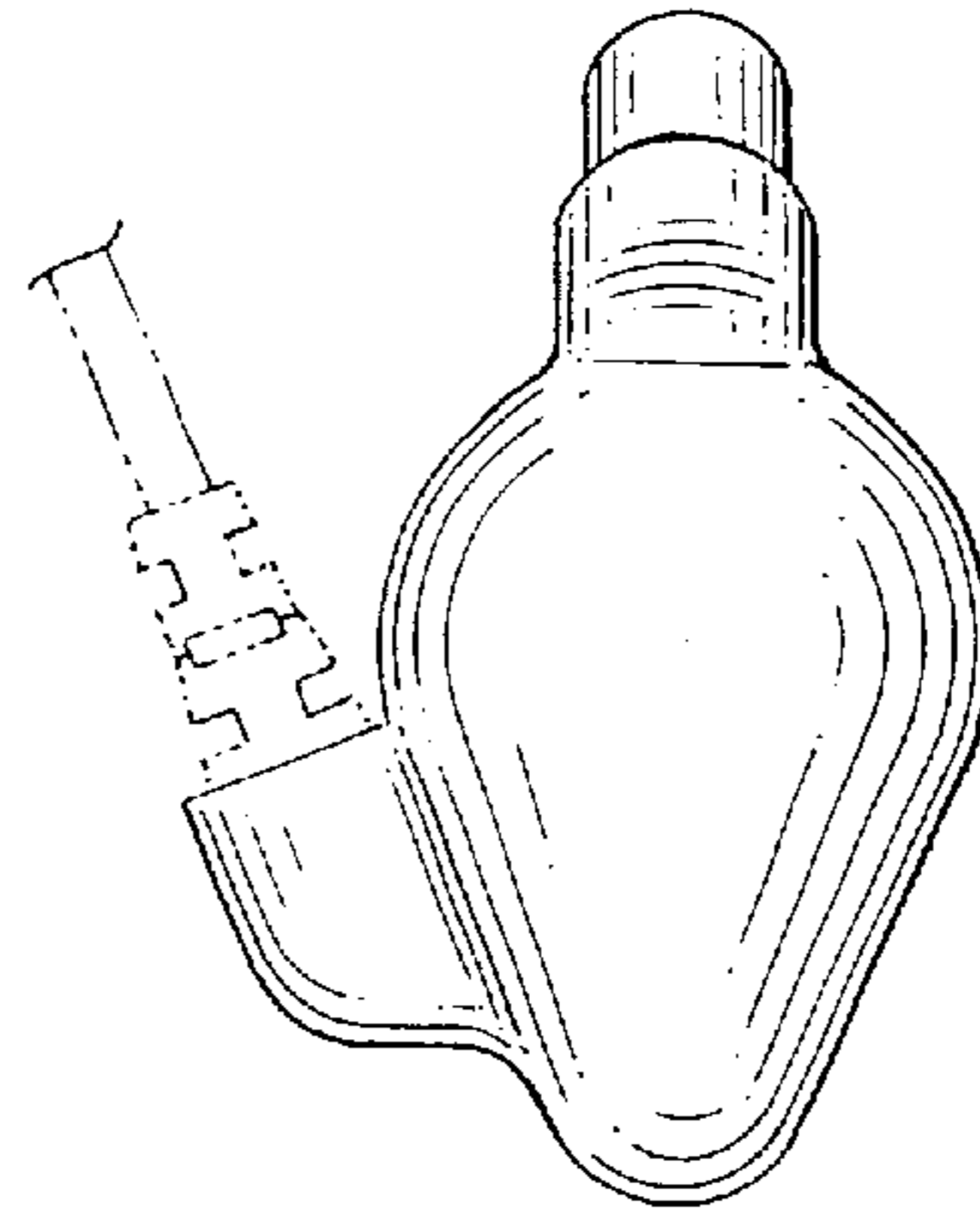

FIG.5

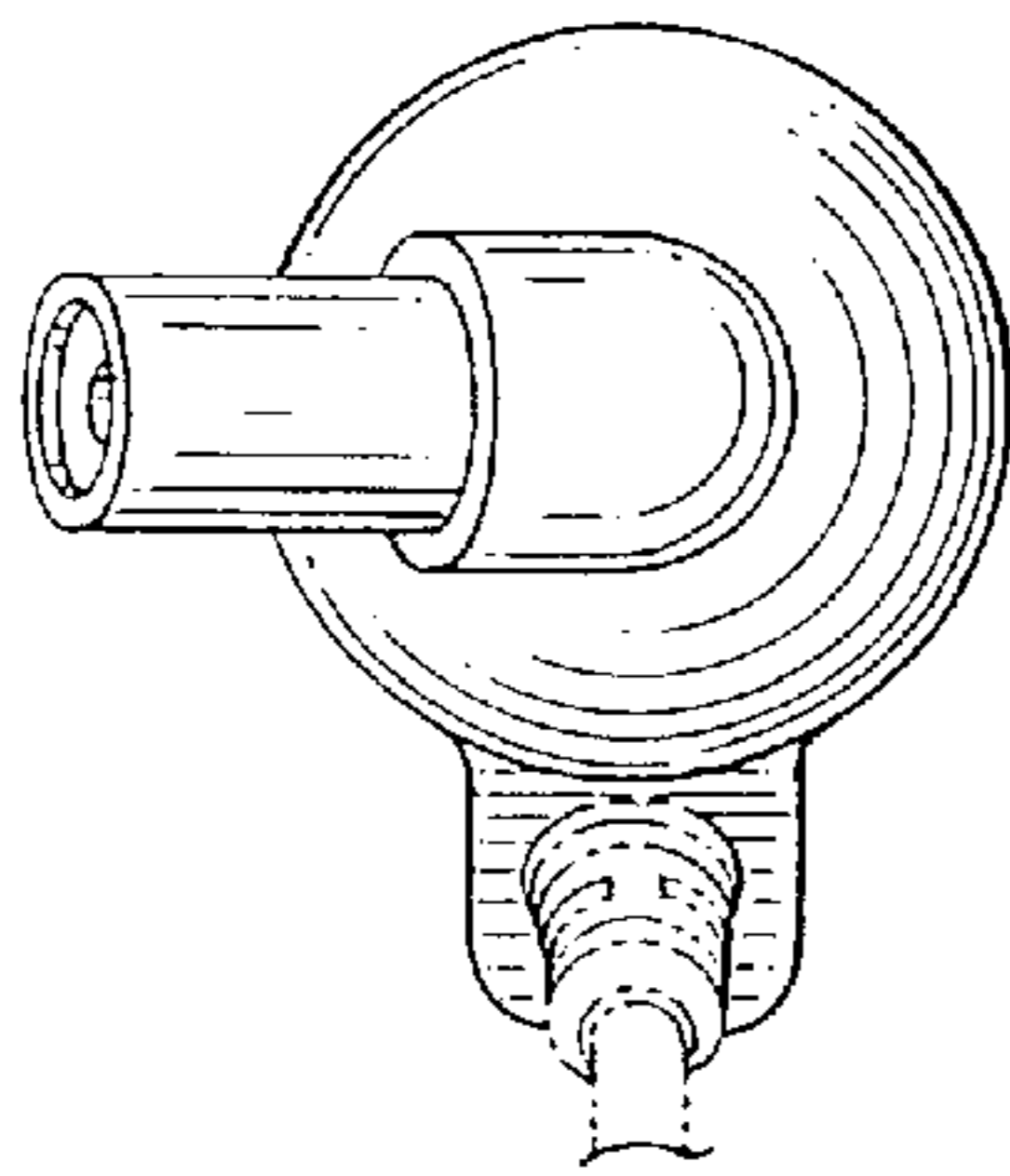

FIG.6

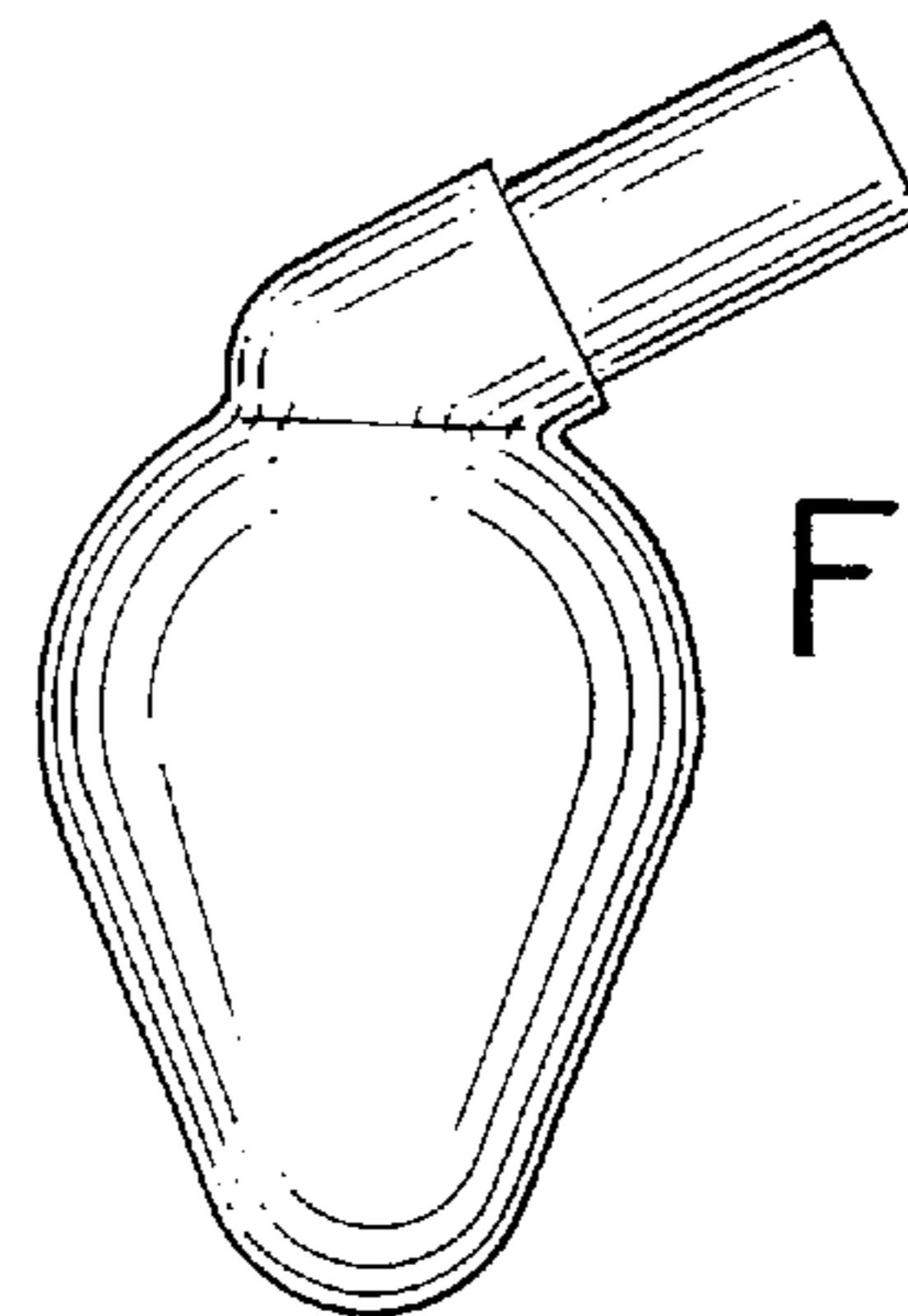

FIG.7

