



US00D488298S

(12) **United States Design Patent**  
**Freeman**

(10) **Patent No.:** **US D488,298 S**

(45) **Date of Patent:** **\*\* Apr. 13, 2004**

(54) **FLATWARE STORAGE CHEST**

(75) Inventor: **Roger Freeman**, Hillsdale, NJ (US)

(73) Assignee: **Cambridge Silversmiths Ltd.**,  
Fairfield, NJ (US)

(\*\*) Term: **14 Years**

(21) Appl. No.: **29/171,367**

(22) Filed: **Nov. 21, 2002**

(51) **LOC (7) Cl.** ..... **03-01**

(52) **U.S. Cl.** ..... **D3/294; D6/470**

(58) **Field of Search** ..... D3/272, 273, 294,  
D3/295; D6/470, 467, 449, 471; 206/6.1,  
566; 312/234

(56) **References Cited**

**U.S. PATENT DOCUMENTS**

|            |   |         |                      |       |        |
|------------|---|---------|----------------------|-------|--------|
| D162,746 S | * | 4/1951  | Oakler et al.        | ..... | D6/470 |
| D167,862 S | * | 9/1952  | Schladermundt et al. | ....  | D6/470 |
| D227,726 S | * | 7/1973  | Sinclair             | ..... | D6/470 |
| D376,710 S | * | 12/1996 | Kara                 | ..... | D6/470 |
| D386,018 S | * | 11/1997 | Tosto, Jr.           | ..... | D6/470 |
| D403,534 S | * | 1/1999  | Gregory et al.       | ..... | D6/470 |
| D417,979 S | * | 12/1999 | Evans                | ..... | D6/470 |
| D418,348 S | * | 1/2000  | Thibadeau            | ..... | D6/559 |
| D422,810 S | * | 4/2000  | Rasp                 | ..... | D6/480 |

**OTHER PUBLICATIONS**

Service Merchandise Catalog, 1996, pp. 186 and 187, Silverware Chests.\*

\* cited by examiner

*Primary Examiner*—Philip S. Hyder

(74) *Attorney, Agent, or Firm*—Weingram & Associates, P.C.

(57) **CLAIM**

I claim the ornamental design for a flatware storage chest, as shown and described.

**DESCRIPTION**

FIG. 1 is an upper left perspective view showing the flatware storage chest of my design with the lid closed.

FIG. 2 is a top plan view of the flatware storage chest shown in FIG. 1.

FIG. 3 is a upper front perspective view of the flatware storage chest shown in FIG. 1., with the lid open.

FIG. 4 is an upper left perspective view of the flatware storage chest shown in FIG. 1, with the lid open.

FIG. 5 is a bottom plan view of the flatware storage chest shown in FIG. 1.

FIG. 6 is a front elevation view of the flatware storage chest shown in FIG. 1.

FIG. 7 is a rear elevation view of the flatware storage chest shown in FIG. 1; and,

FIG. 8 is a right elevation view, which is a mirror image of the left elevation view, of the flatware storage chest shown in FIG. 1.

**1 Claim, 8 Drawing Sheets**

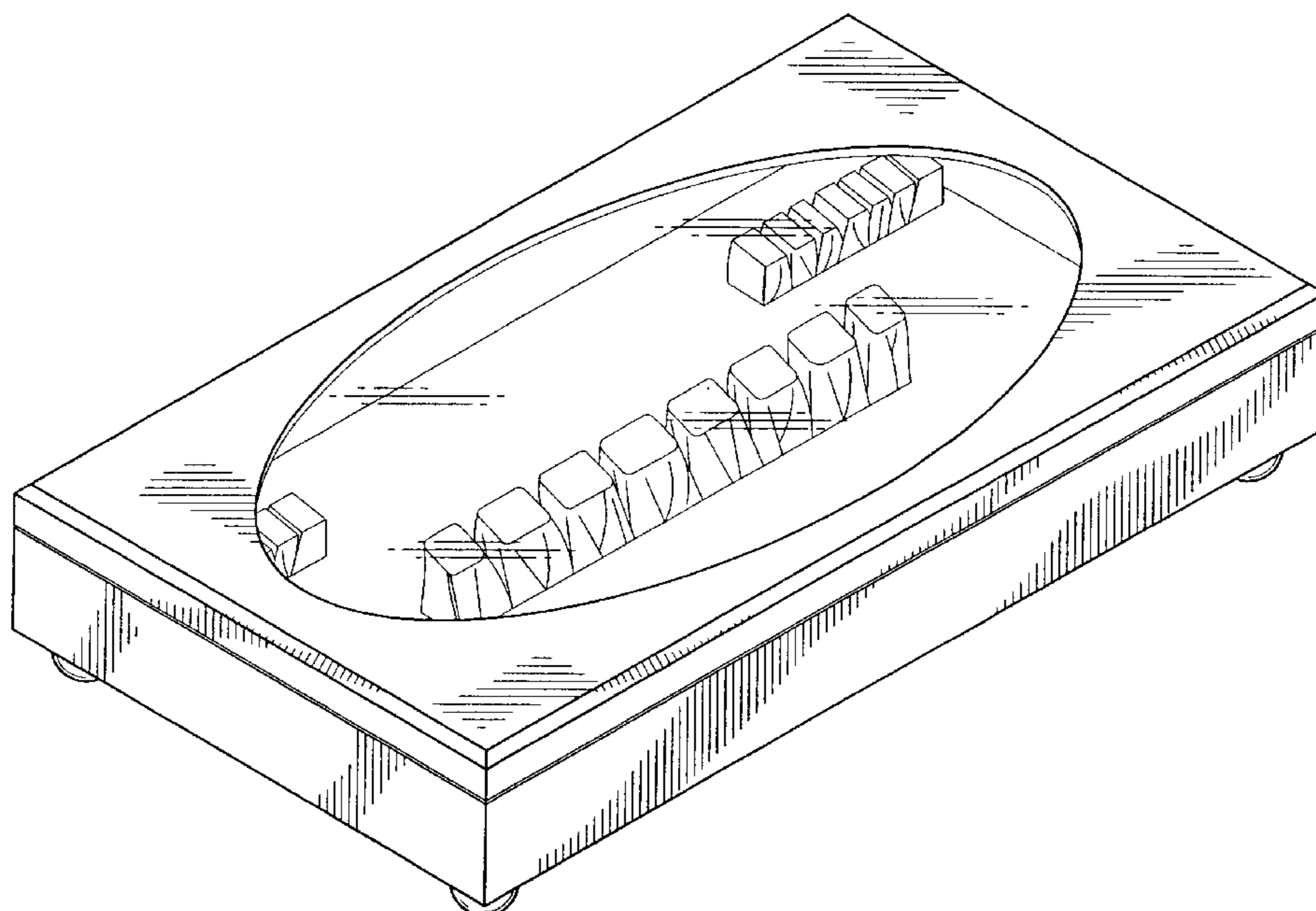

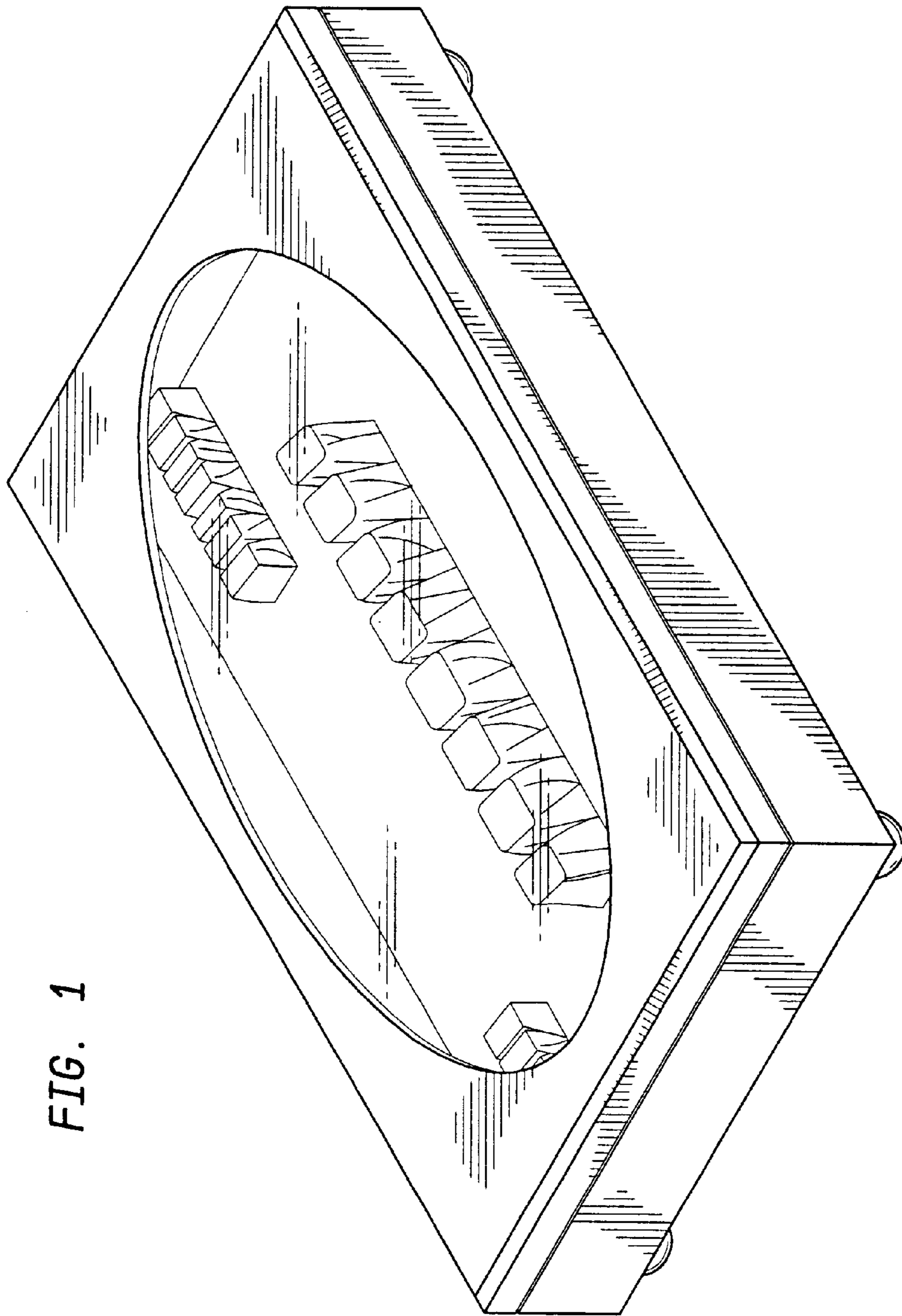

FIG. 1

FIG. 2

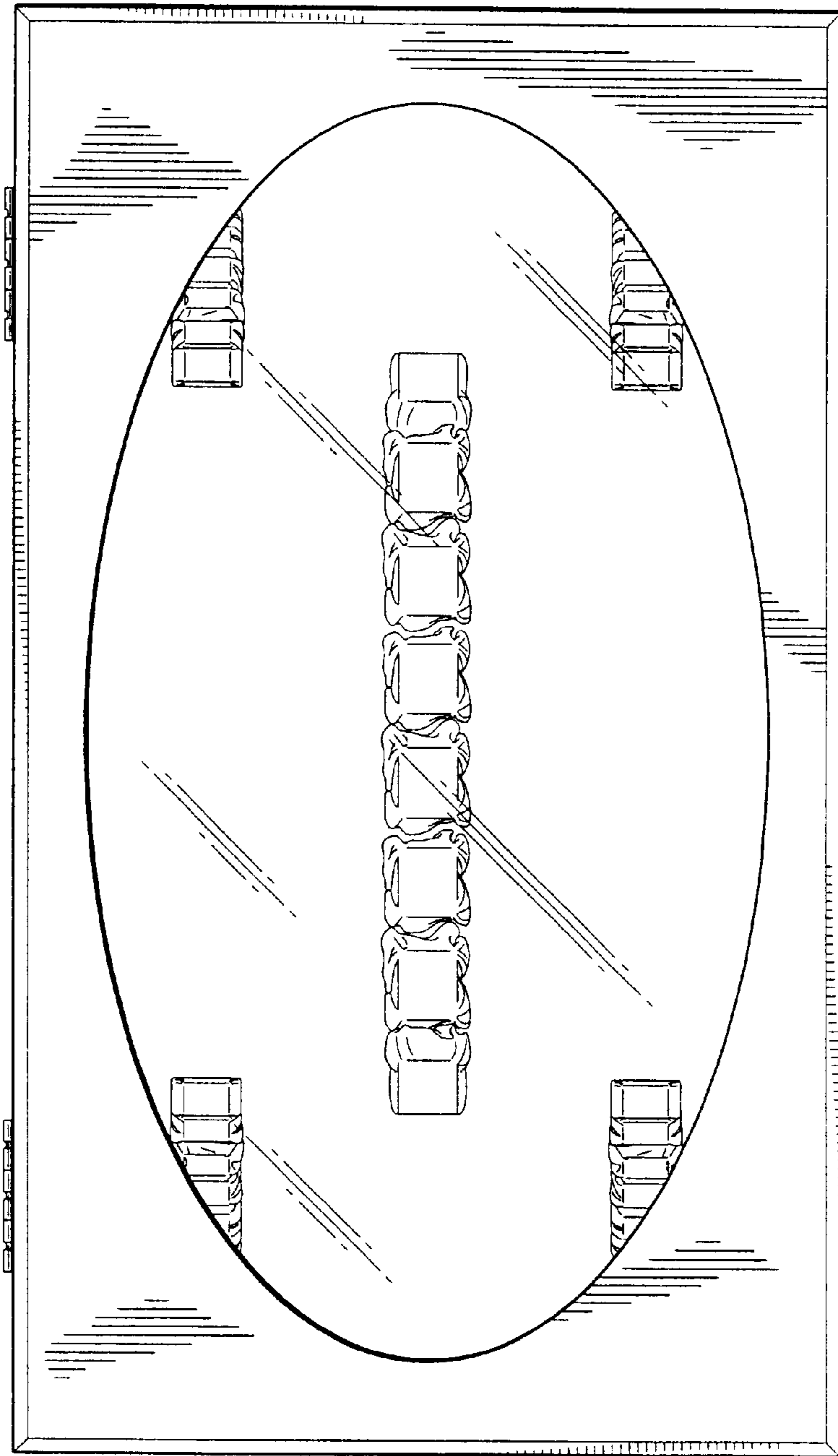

FIG. 3

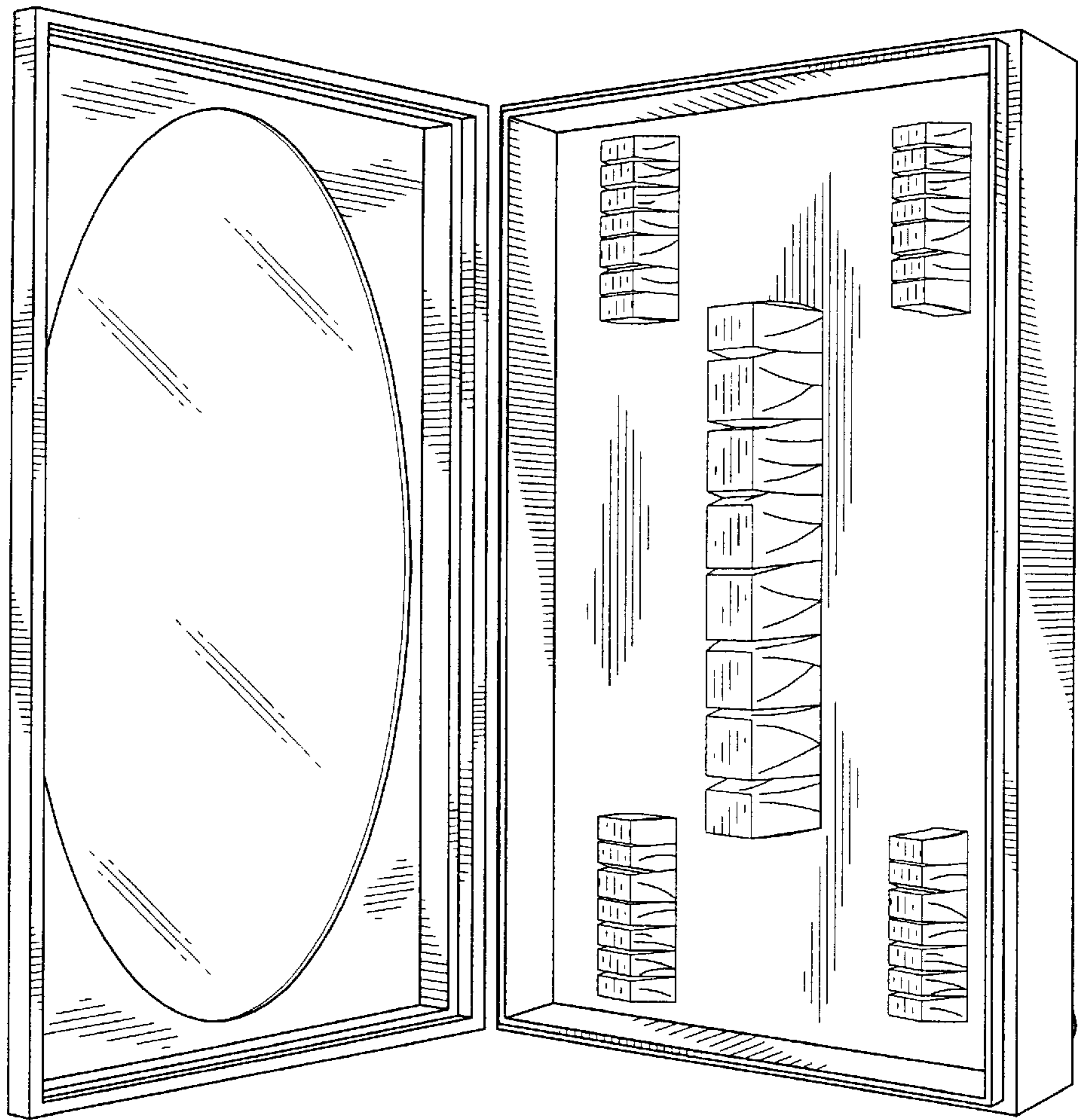

FIG. 4

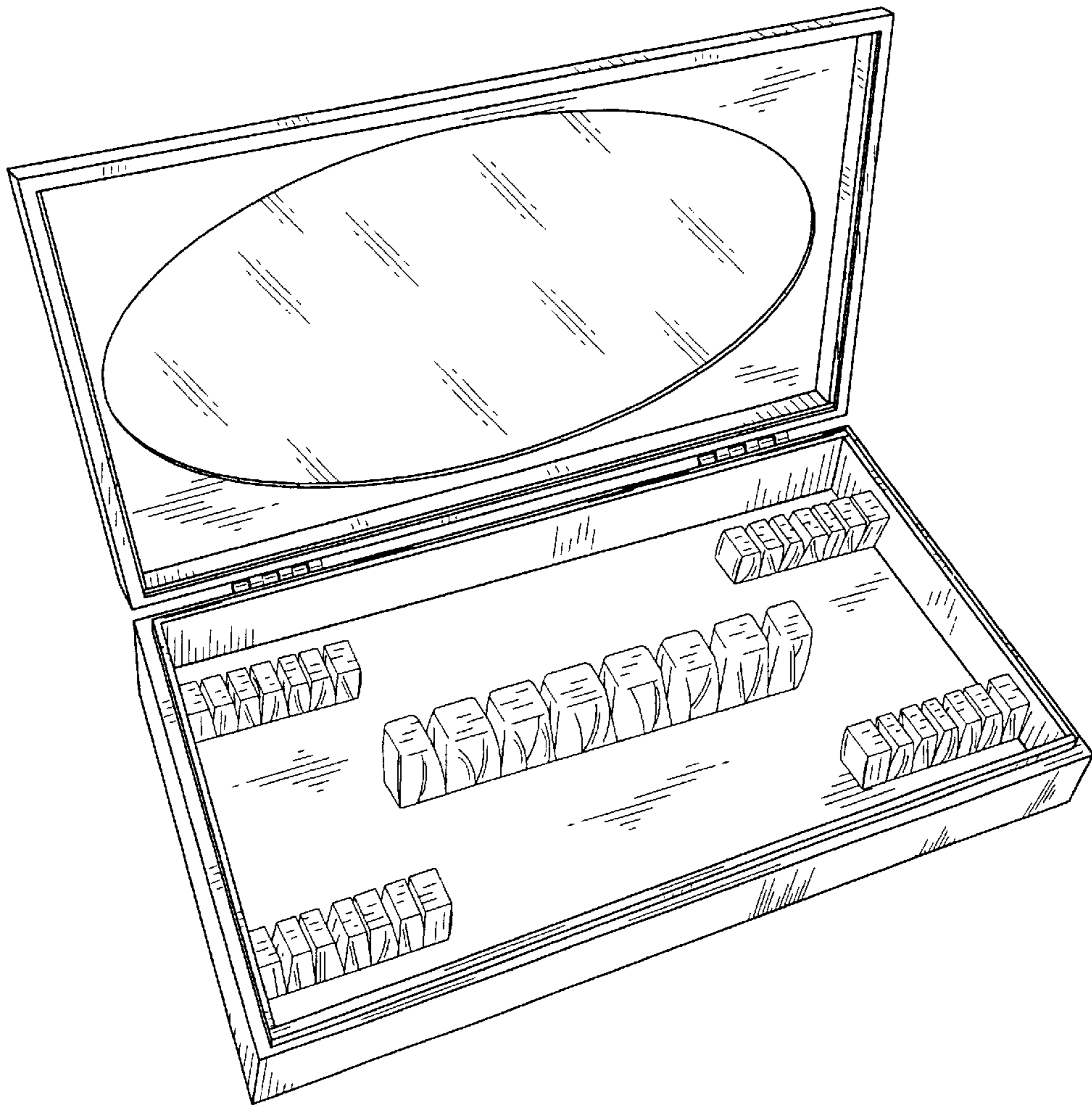

FIG. 5

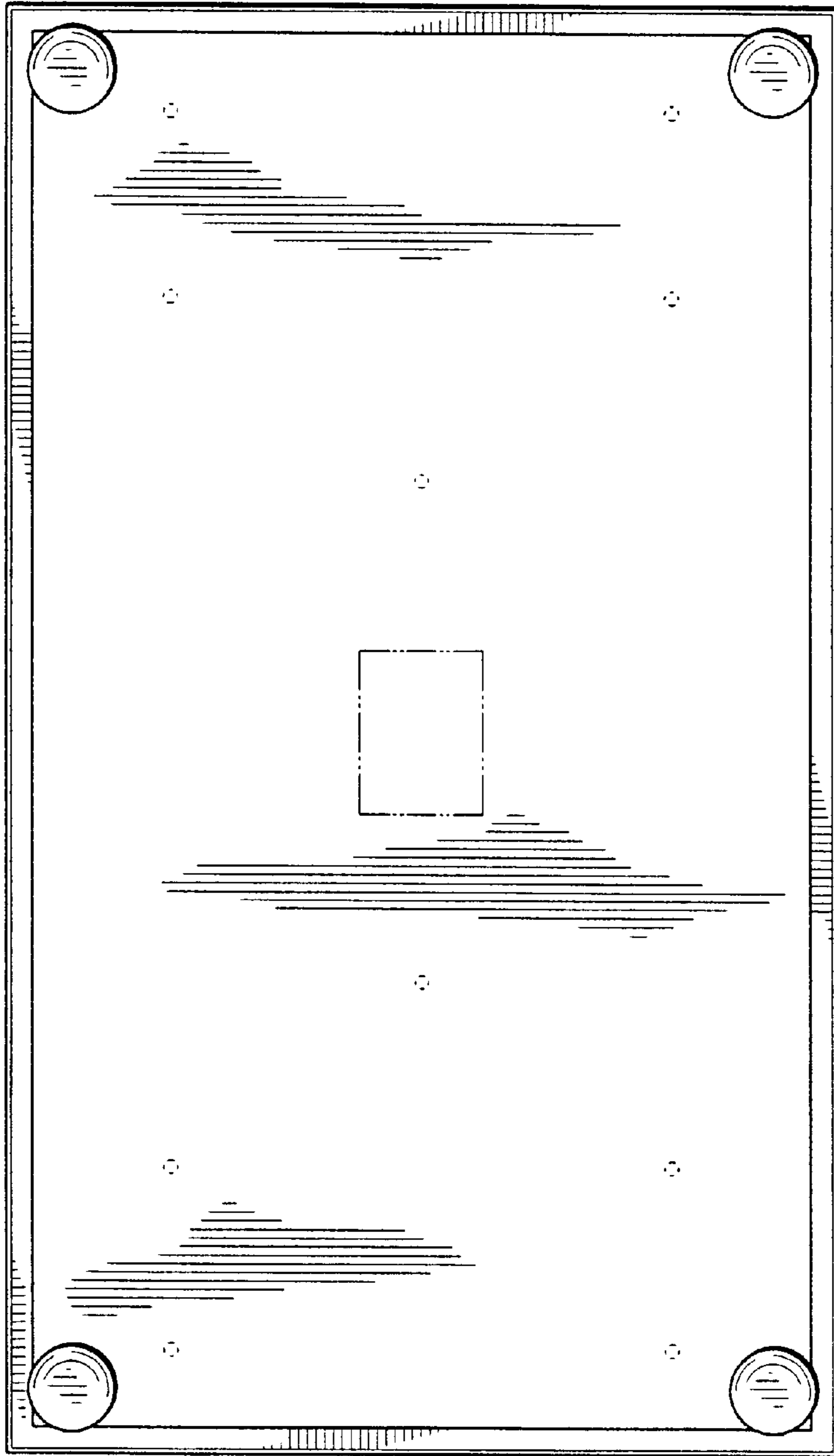

FIG. 6

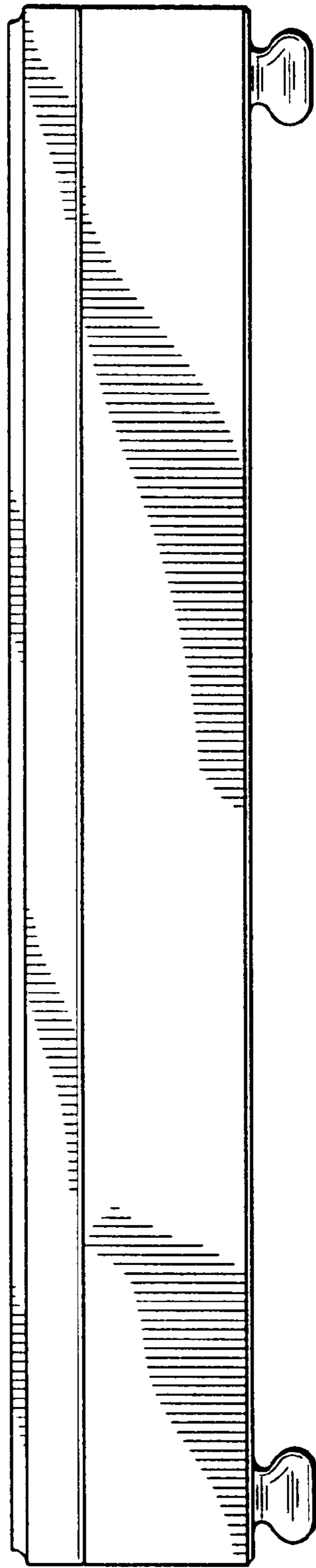

FIG. 7

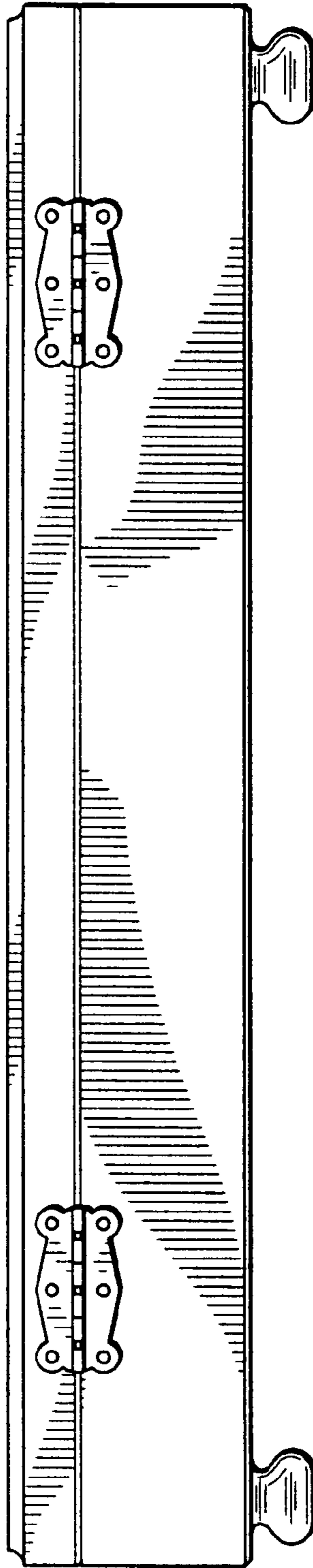



FIG. 8

