



US00D488297S

(12) **United States Design Patent**
Vazquez

(10) **Patent No.:** **US D488,297 S**
(45) **Date of Patent:** **** Apr. 13, 2004**

(54) **VARIABLE U-SHAPED BAG WITH CHANNELS**

(76) Inventor: **Maximino Vazquez**, 213 W. 14th St.,
New York, NY (US) 10011

(**) Term: **14 Years**

(21) Appl. No.: **29/157,832**

(22) Filed: **Mar. 26, 2002**

Related U.S. Application Data

(63) Continuation-in-part of application No. 29/134,502, filed on
Dec. 22, 2000.

(51) **LOC (7) Cl.** **03-01**

(52) **U.S. Cl.** **D3/244**

(58) **Field of Search** D3/232, 233, 234,
D3/244, 300; D9/305; 190/102, 103, 107;
383/2, 38, 76; 40/10; 150/100, 107, 108,
110, 130

(56) **References Cited**

U.S. PATENT DOCUMENTS

1,207,533 A 12/1916 Gamble 383/38

(List continued on next page.)

Primary Examiner—Louis S. Zarfaz

Assistant Examiner—Monica A. Weingart

(74) *Attorney, Agent, or Firm*—Darby & Darby

(57) **CLAIM**

The ornamental design for a variable U-shaped bag with channels, as shown and described.

DESCRIPTION

FIG. 1 is a front elevational view of a variable U-shaped bag with channels in a substantially uncompressed state and further shows the same in an uncinched condition and having a carry strap; the rear elevational view being a mirror image thereof;

FIG. 2 is a front elevational view of the variable U-shaped bag with channels in a partially compressed state and further shows same in an uncinched condition, the rear elevational view being a mirror image thereof;

FIG. 3 is a front elevational view of the variable U-shaped bag with channels in a substantially compressed state and further shows the same in an uncinched condition, the rear elevational view being a mirror image thereof;

FIG. 4 is a left side view of the variable U-shaped bag with channels of FIG. 1, the right side view being the mirror image thereof;

FIG. 5 is a left side view of the variable U-shaped bag with channels of FIG. 2; the right side view being the mirror image thereof;

FIG. 6 is a left side view of the variable U-shaped bag with channels of FIG. 3; the right side view being the mirror image thereof;

FIG. 7 is a front elevational view of the variable U-shaped bag with channels of FIG. 1 shown in a cinched condition; the rear elevational view being a mirror image thereof;

FIG. 8 is a front elevational view of the variable U-shaped bag with channels of FIG. 2 shown in a cinched condition; the rear elevational view being a mirror image thereof;

FIG. 9 is a front elevational view of the variable U-shaped bag with channels of FIG. 3 shown in a cinched condition; the rear elevational view being a mirror image thereof;

FIG. 10 is a left side elevational view of the variable U-shaped bag with channels of FIG. 1, the right side view being the mirror image thereof;

FIG. 11 is a left side view of the variable U-shaped bag with channels of FIG. 8, the right side view being the mirror image thereof;

FIG. 12 is a left side view of the variable U-shaped bag with channels of FIG. 9, the right side view being the mirror image thereof;

FIG. 13 is a top perspective view of the variable U-shaped bag with channels of FIG. 1;

FIG. 14 is a bottom perspective view of the variable U-shaped bag with channels of FIG. 1;

FIG. 15 is a top perspective view of the variable U-shaped bag with channels of FIG. 7 wherein the carry strap is shown slackened for clarity of top view; and,

FIG. 16 is a bottom perspective view of the variable U-shaped bag with channels of FIG. 7, wherein the carry strap is shown slackened for clarity of bottom view.

The broken lines showing carry strap and cord are to show environment only and are not part of the claimed design.

1 Claim, 5 Drawing Sheets

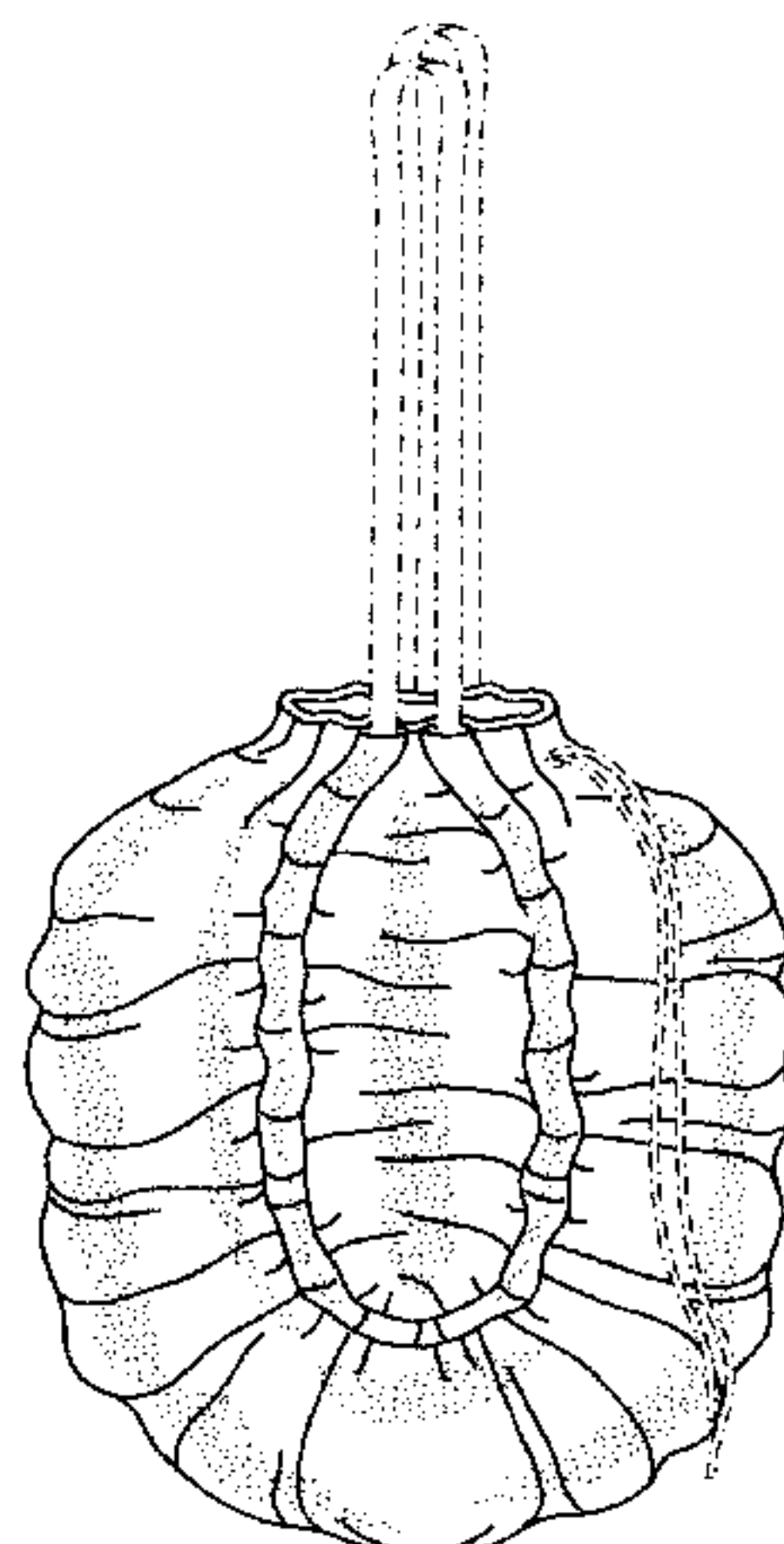
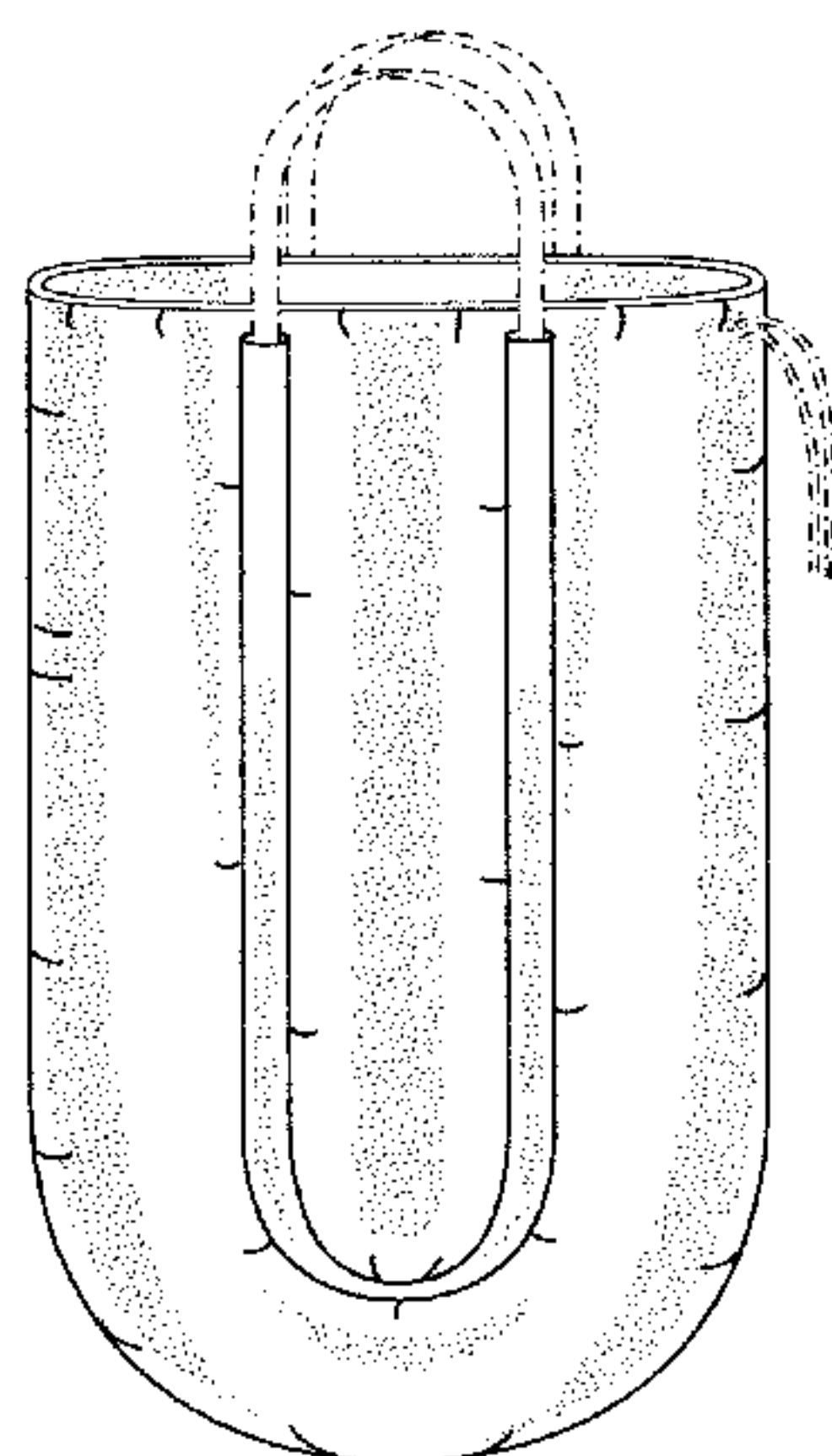

US D488,297 S

Page 2

U.S. PATENT DOCUMENTS

1,505,012 A *	8/1924	Distefano	150/130	5,050,999 A	9/1991	Van Loon, III	383/76
D113,486 S *	2/1939	Clark	150/107	D360,712 S	7/1995	Bush	D3/244
D135,261 S *	3/1943	Sloane et al.	D3/244	D369,467 S	5/1996	Cole	D3/300
2,575,893 A	11/1951	Seamon	383/2	D374,975 S	10/1996	Vargas et al.	D3/244
3,746,066 A *	7/1973	McIntyre	150/107	D387,555 S	12/1997	Miller	D3/244
4,196,534 A	4/1980	Shibamoto	40/10	5,765,691 A	6/1998	Hall	383/2 X
4,222,468 A	9/1980	De Fries	190/102	6,089,752 A	7/2000	Moore	383/2
4,267,868 A	5/1981	Lowe	383/2	D437,481 S	2/2001	Vazquez	D3/244
D273,833 S	5/1984	Taylor et al.	D3/244	D453,620 S	2/2002	Vazquez	D3/244
D307,064 S *	4/1990	Roberts	D3/244 X					

* cited by examiner

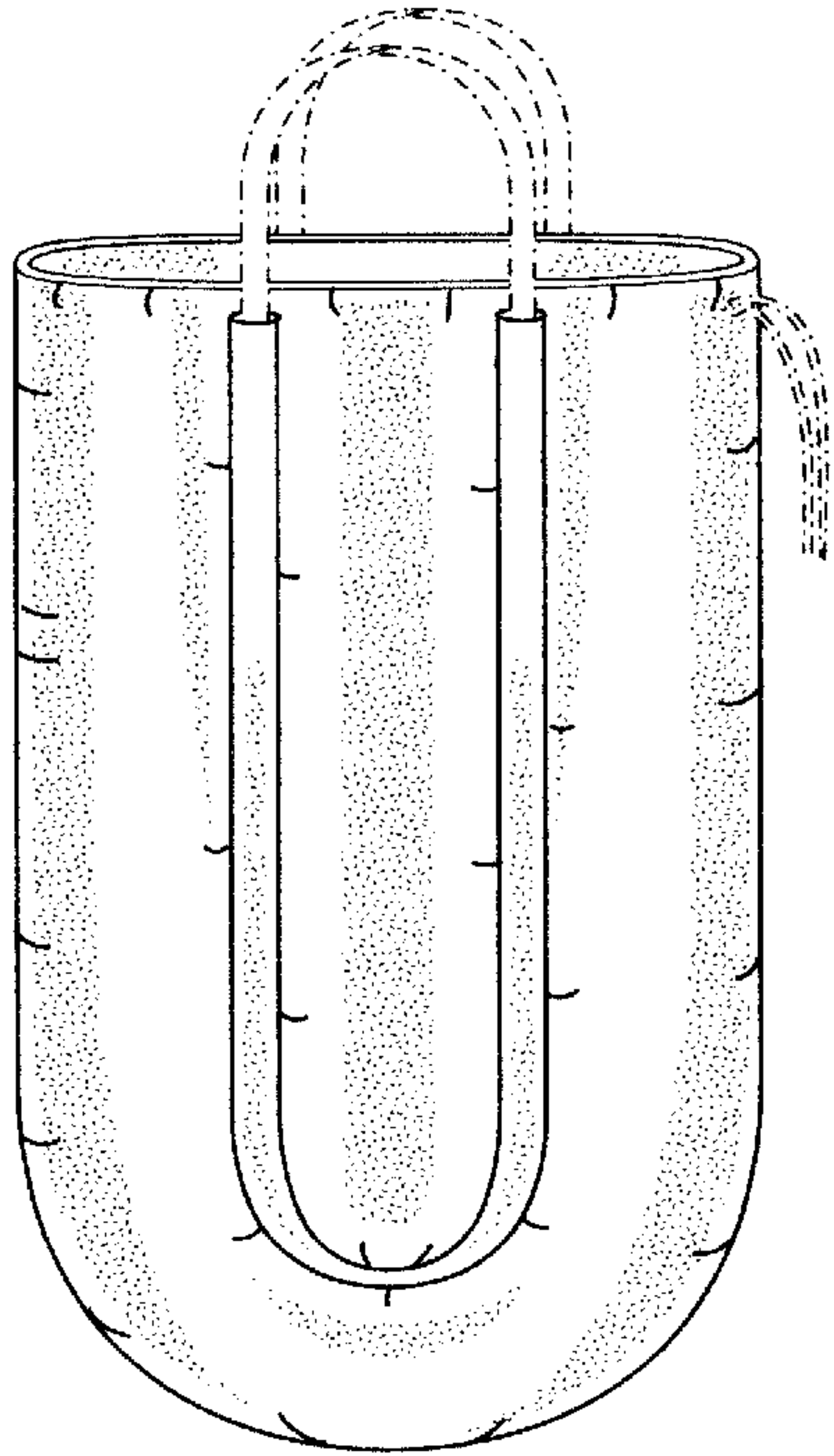

FIG. 1

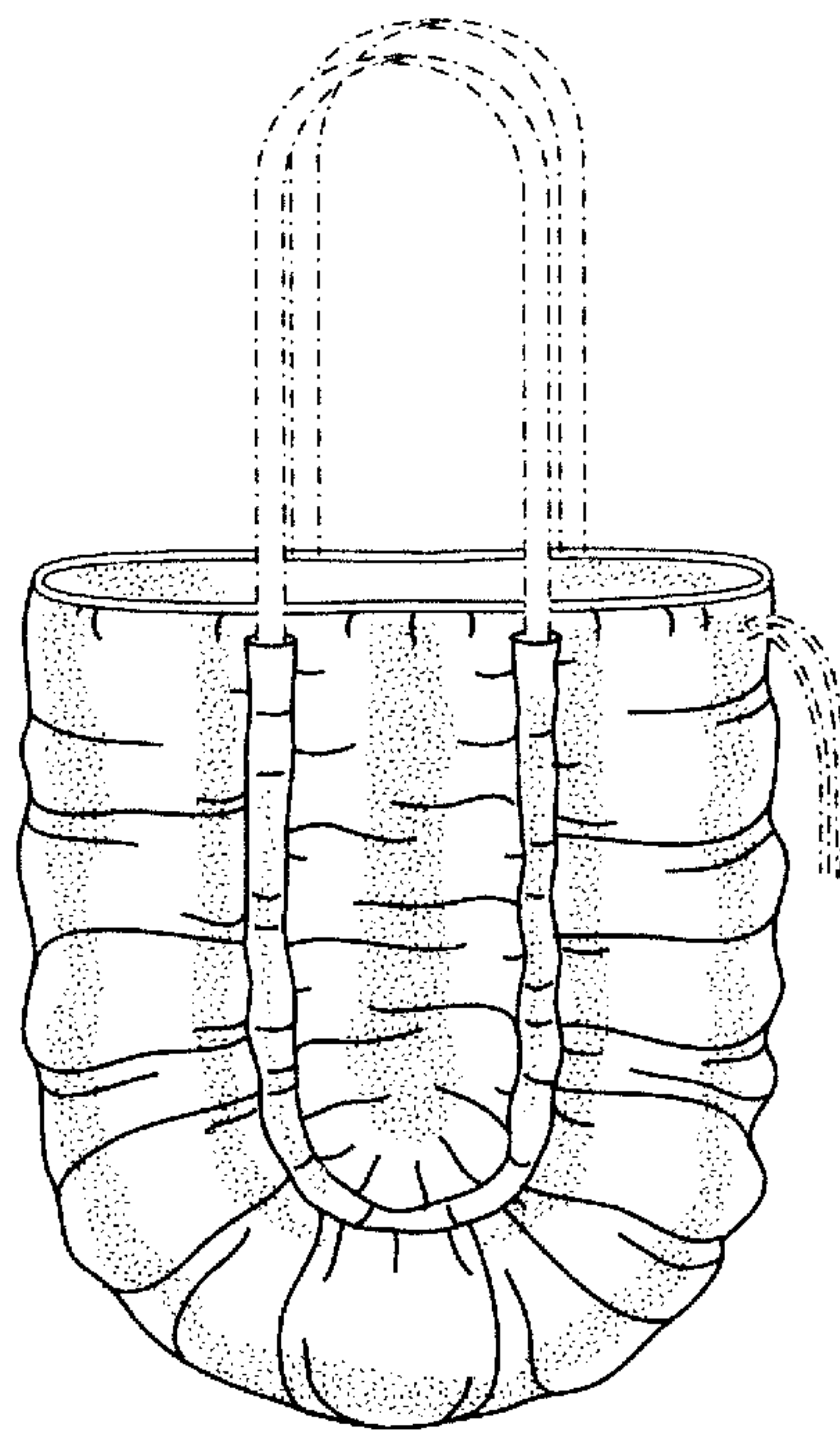

FIG. 2

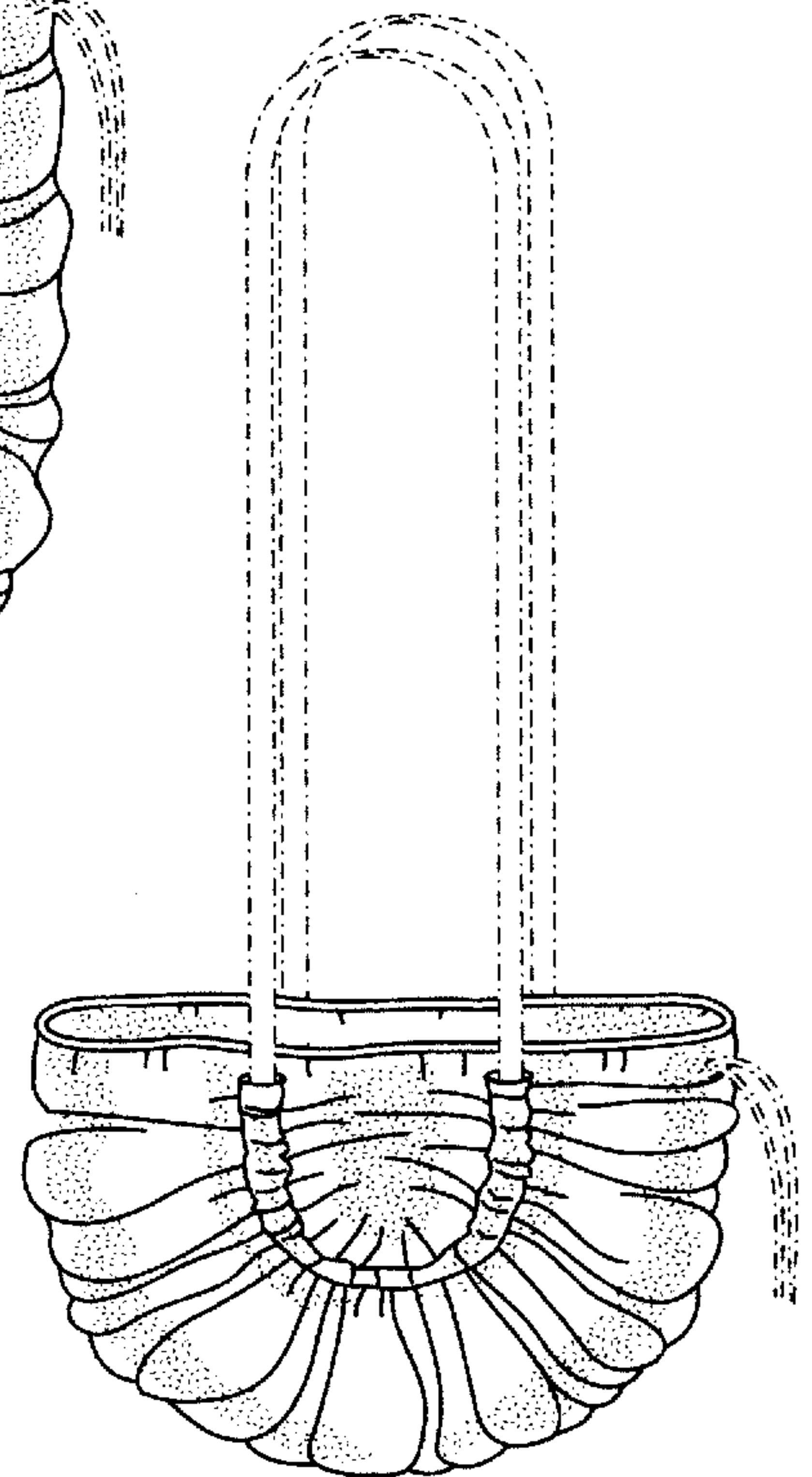

FIG. 3

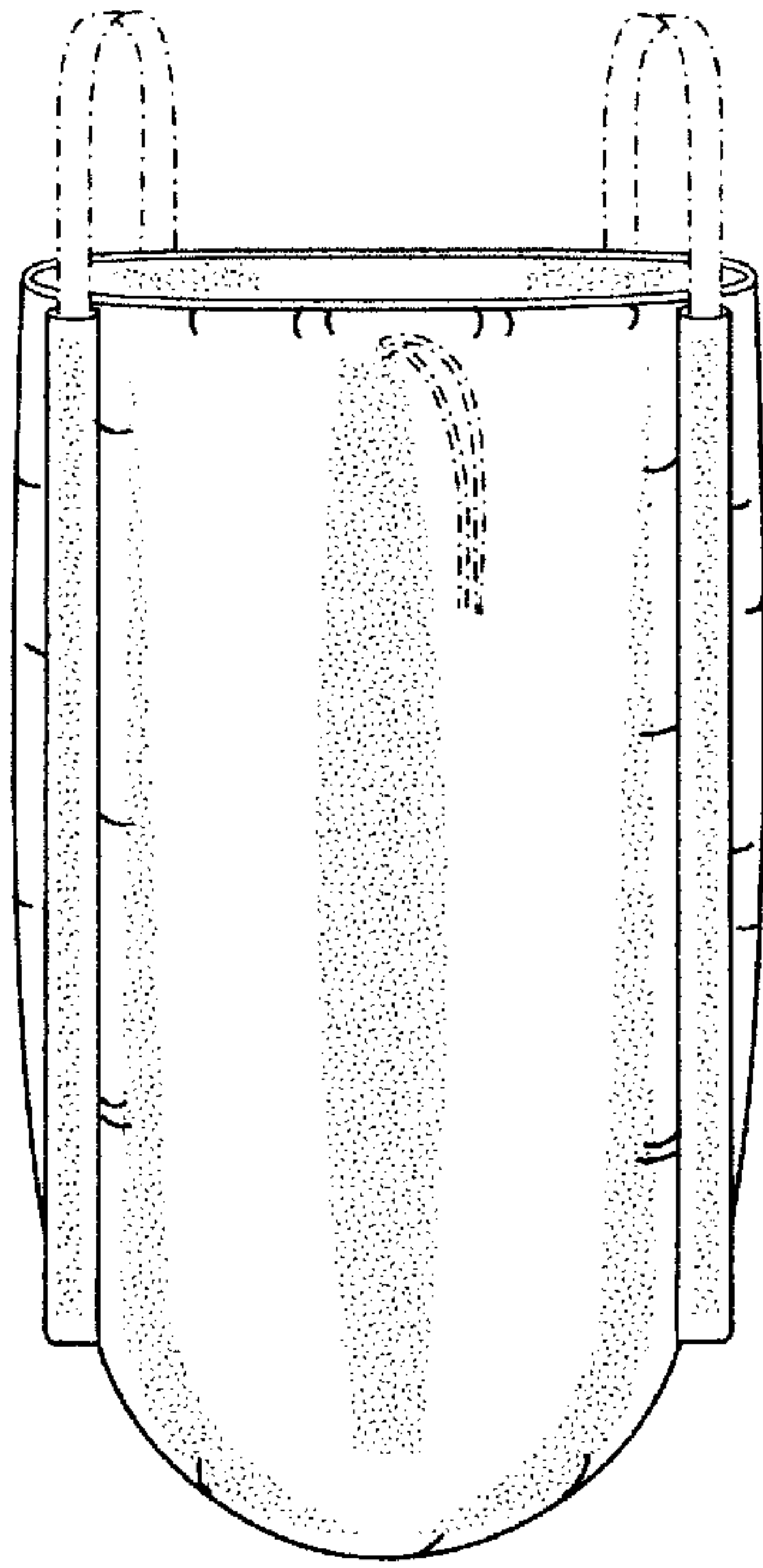

FIG. 4

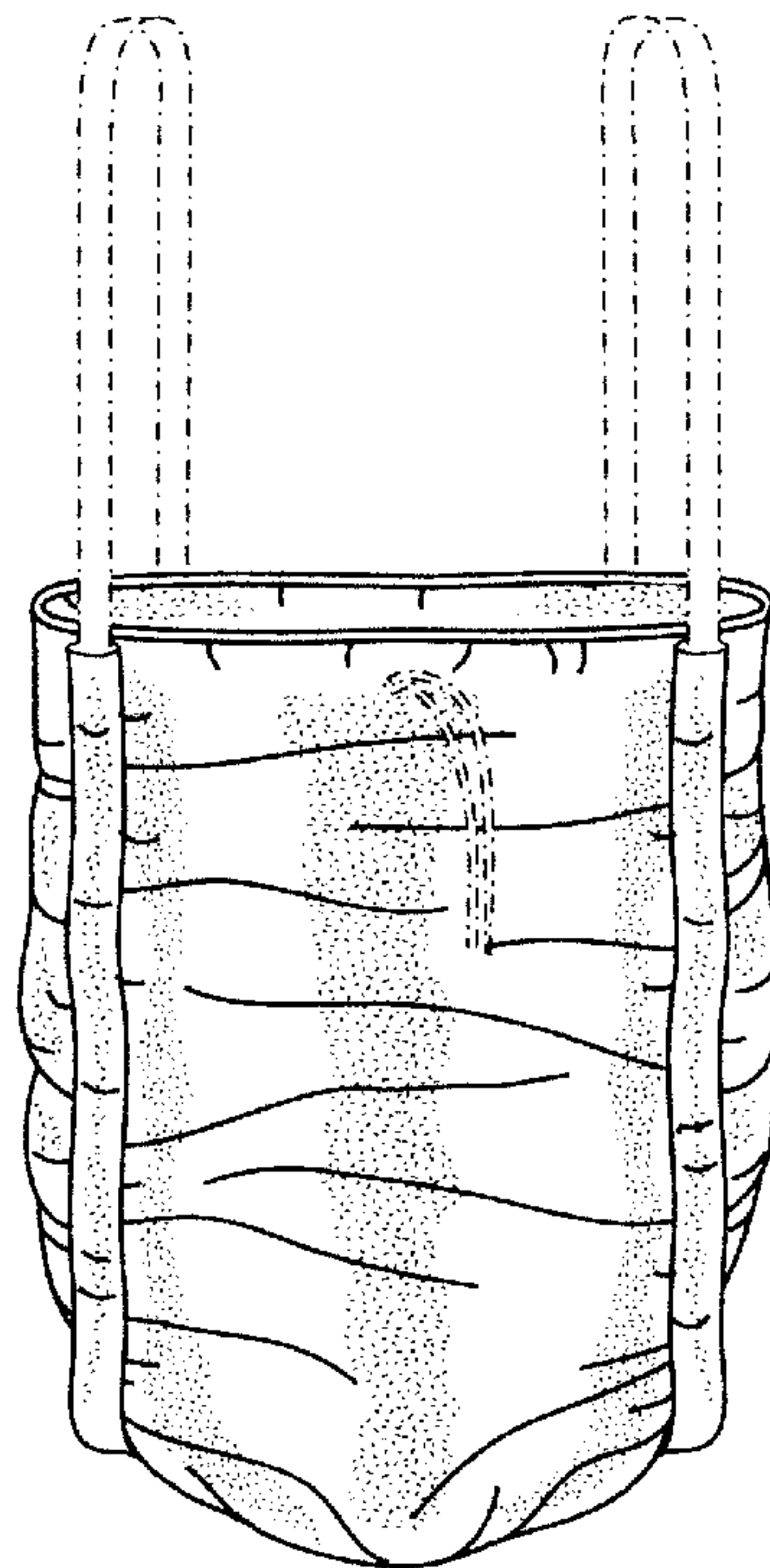

FIG. 5

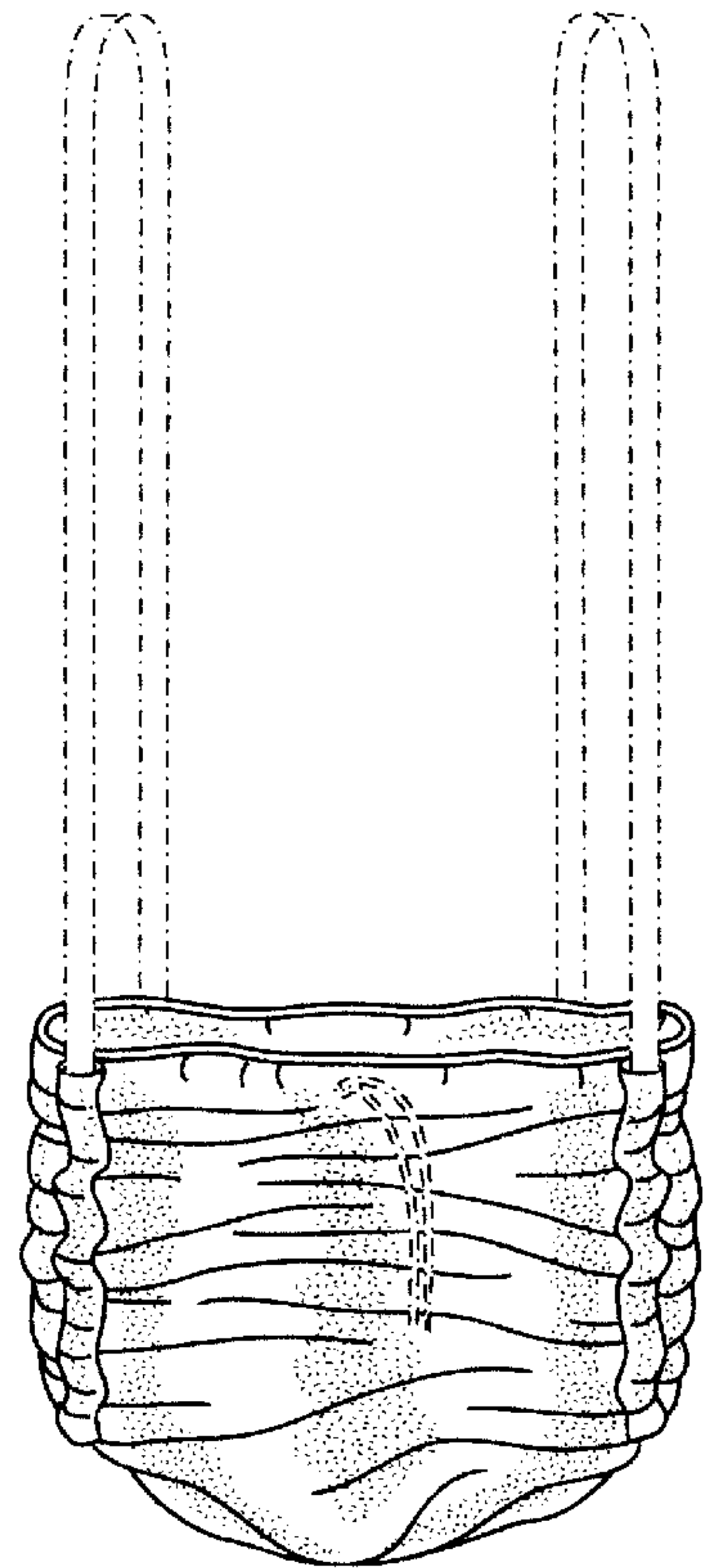

FIG. 6

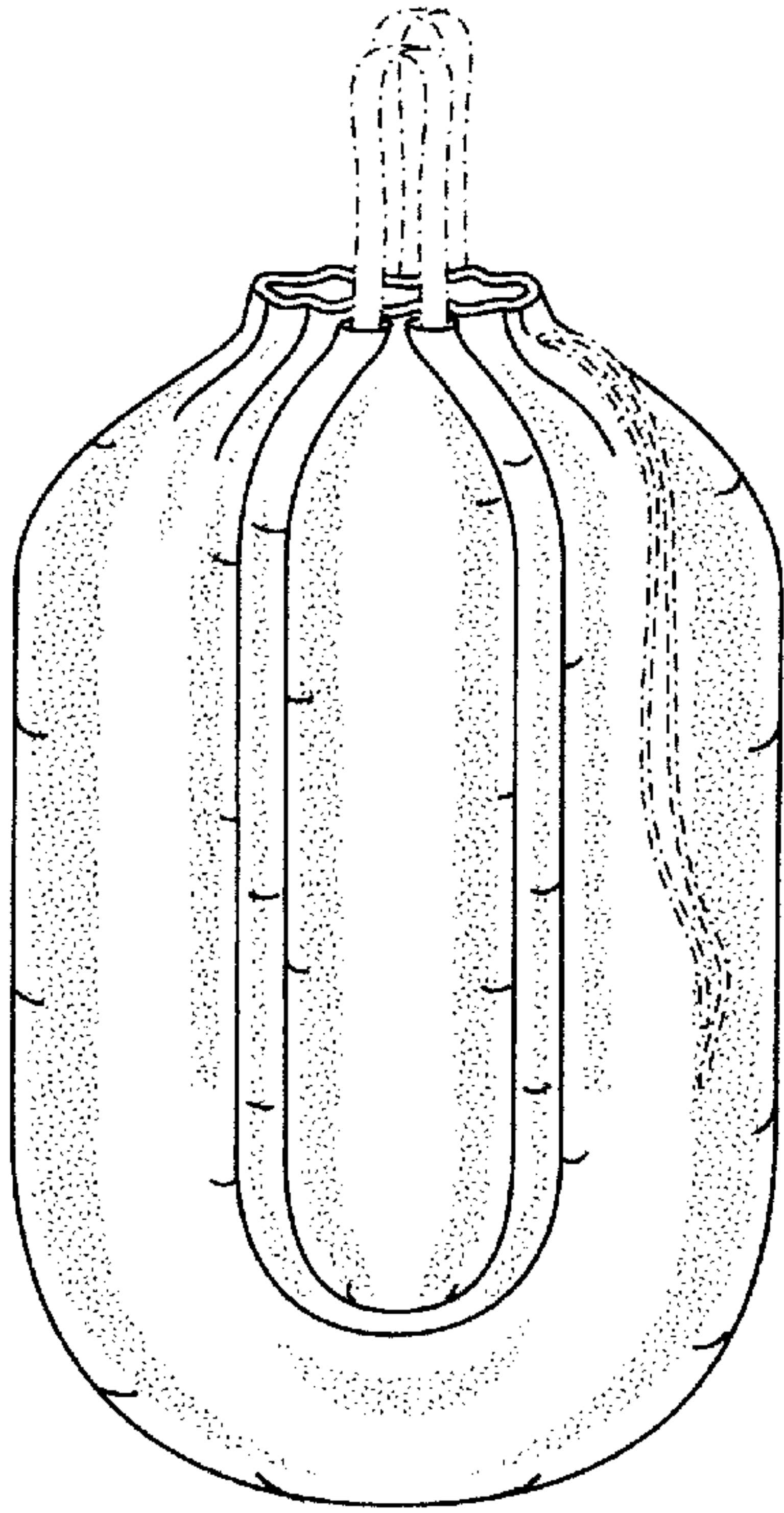

FIG. 7

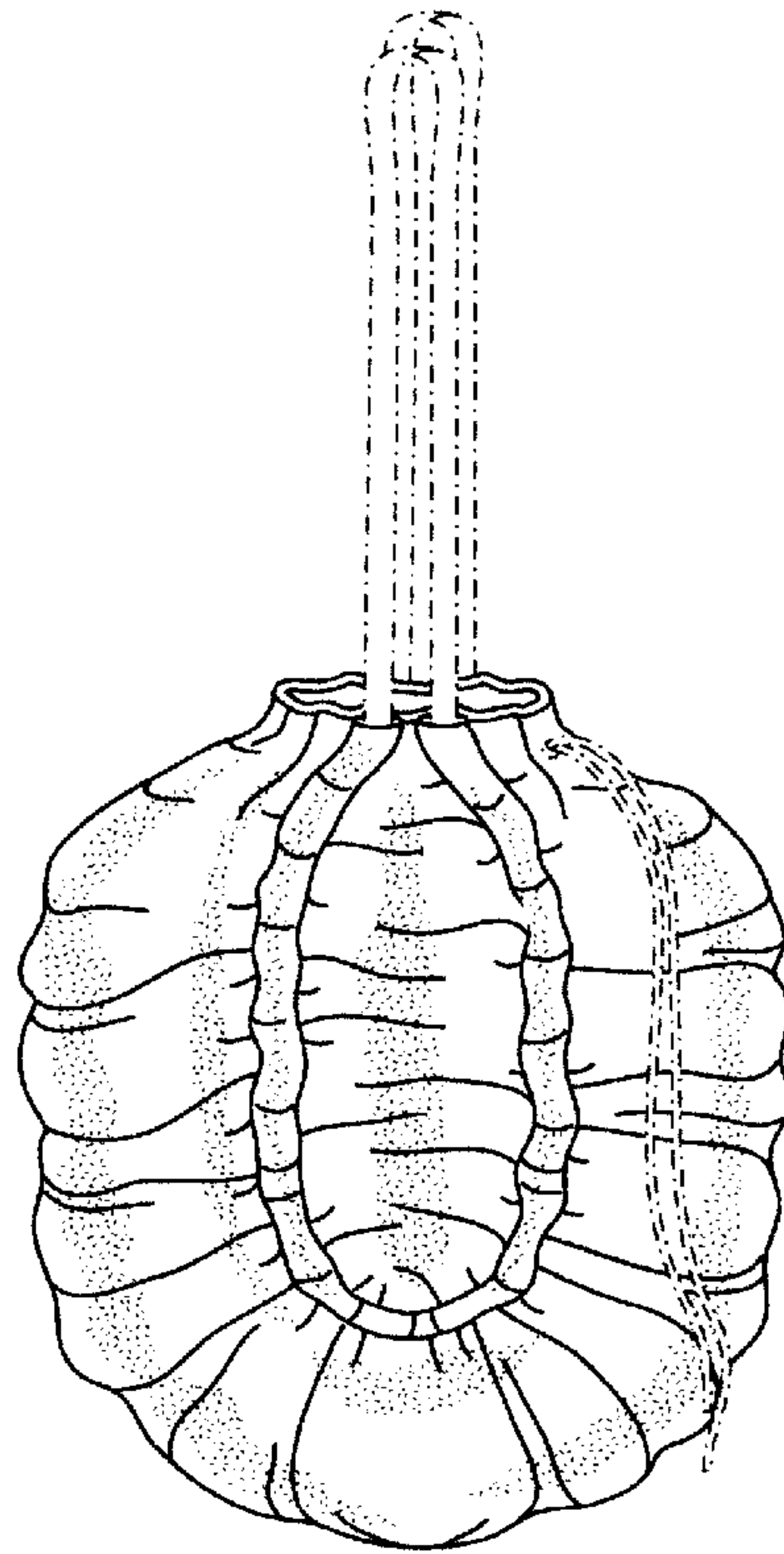

FIG. 8

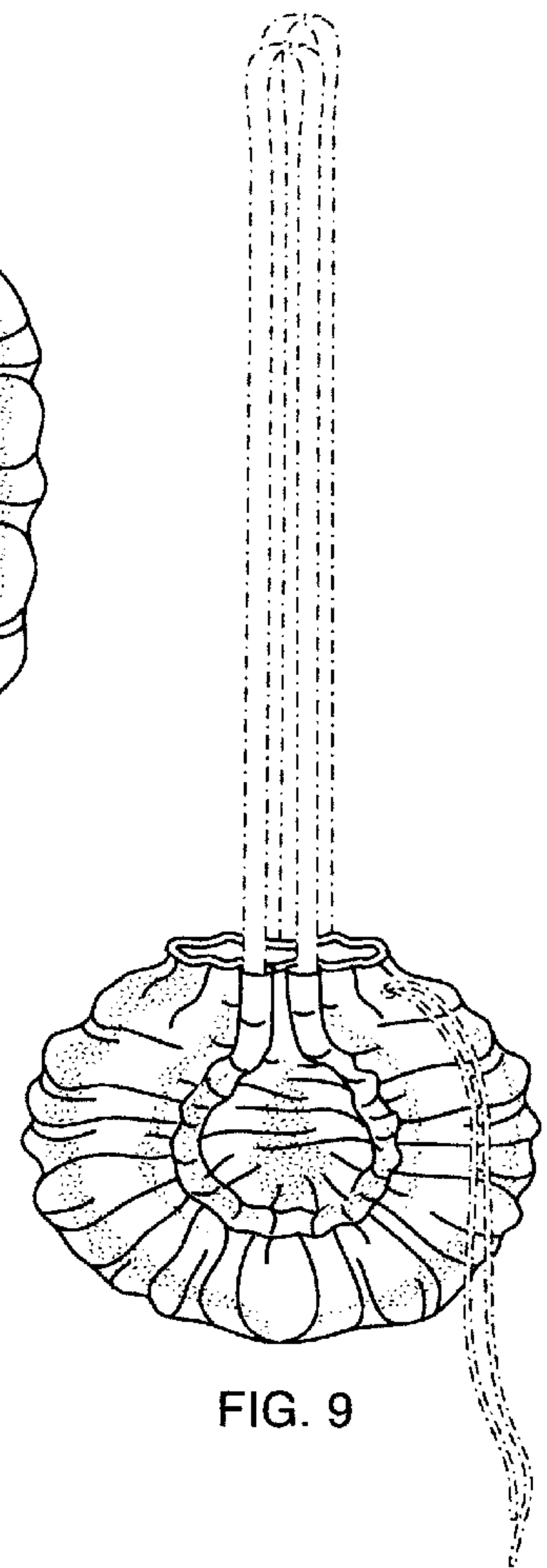

FIG. 9

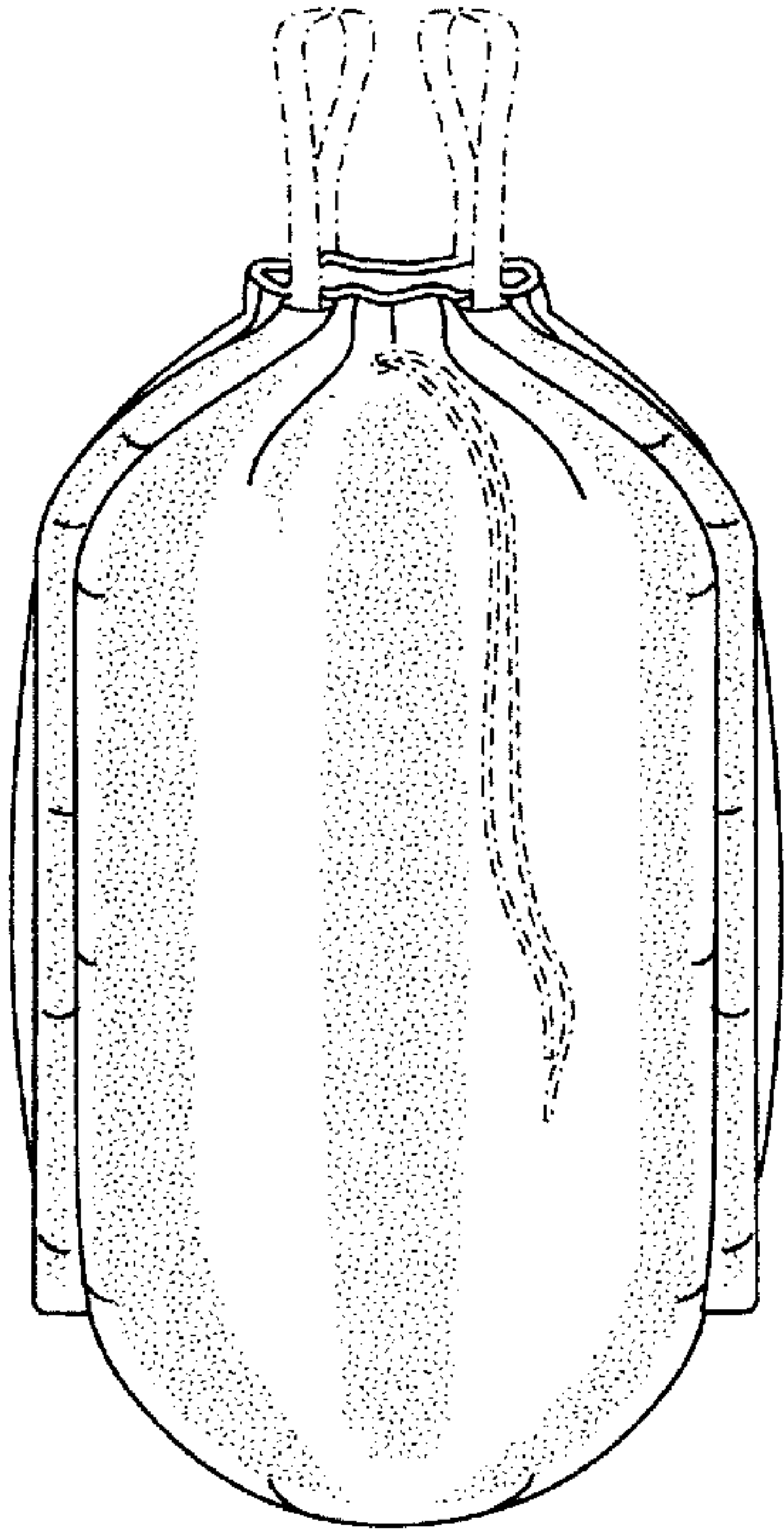

FIG. 10

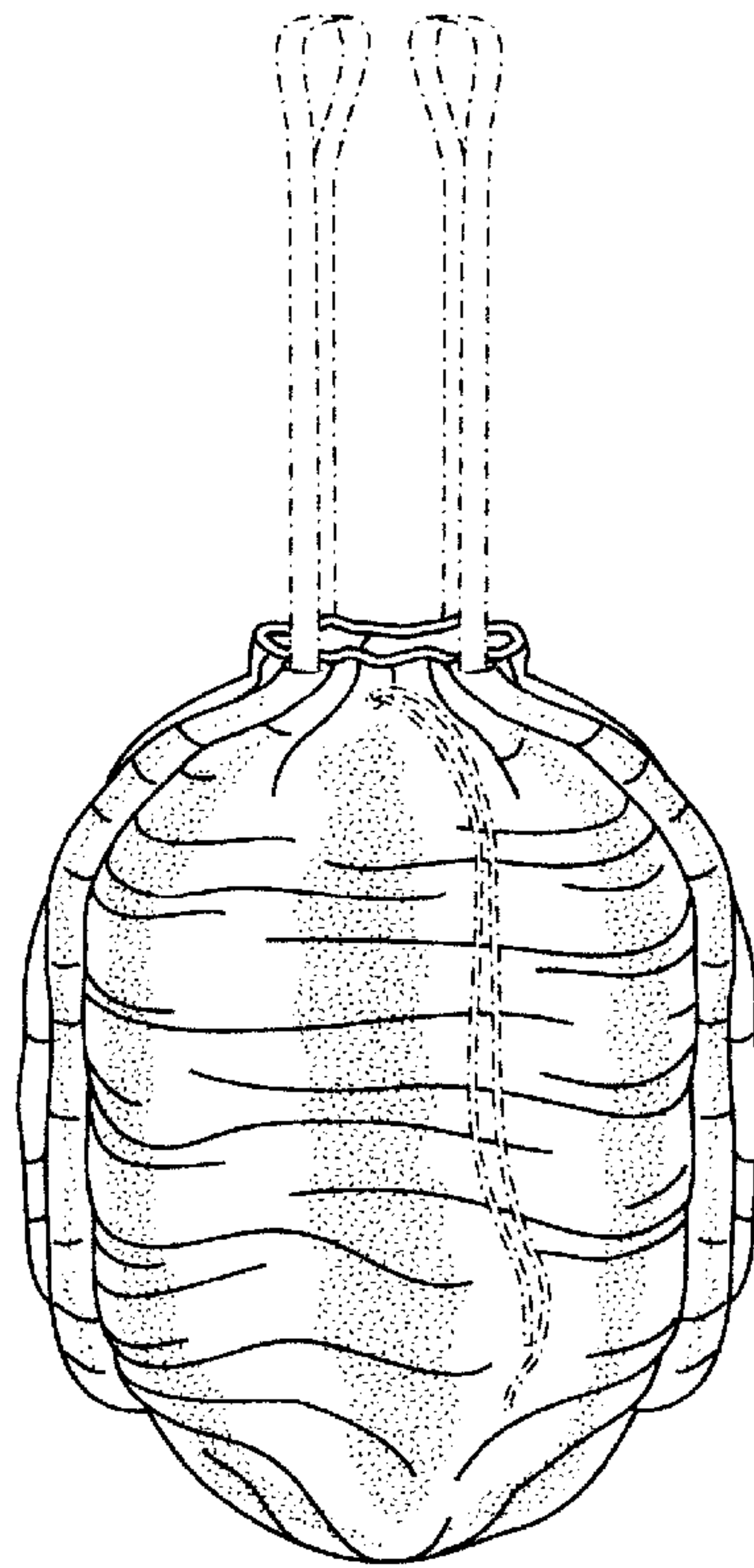

FIG. 11

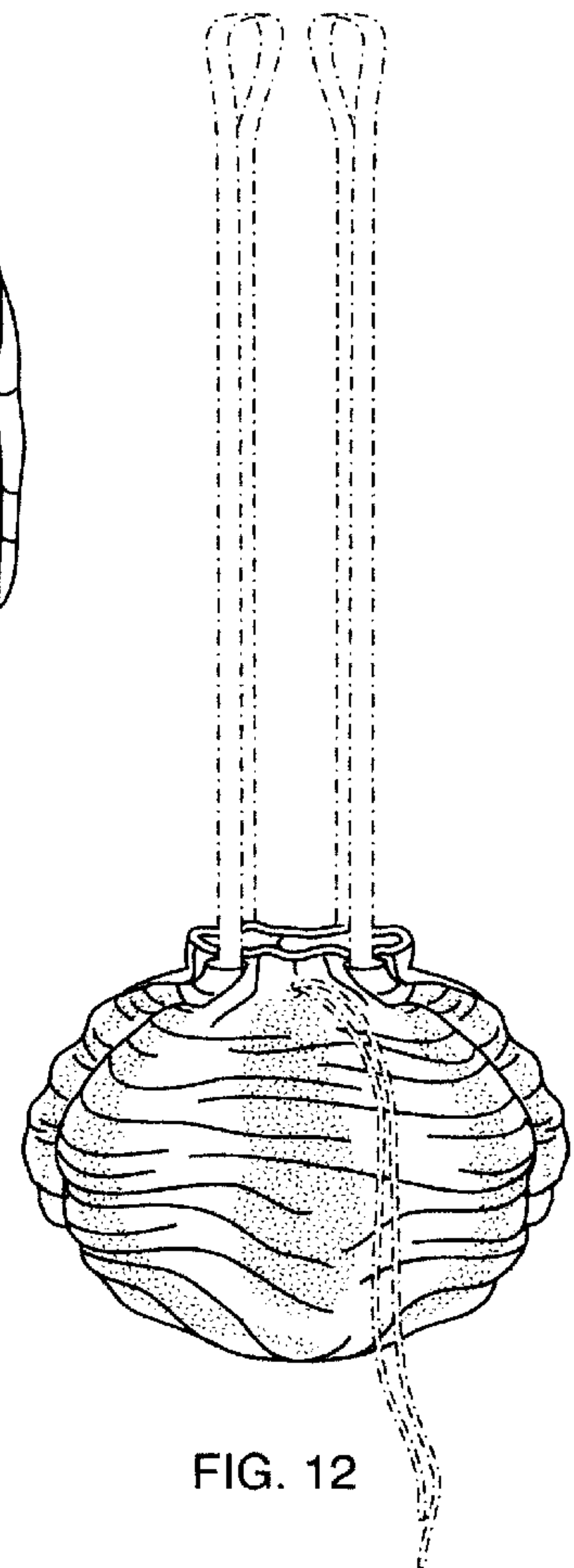

FIG. 12

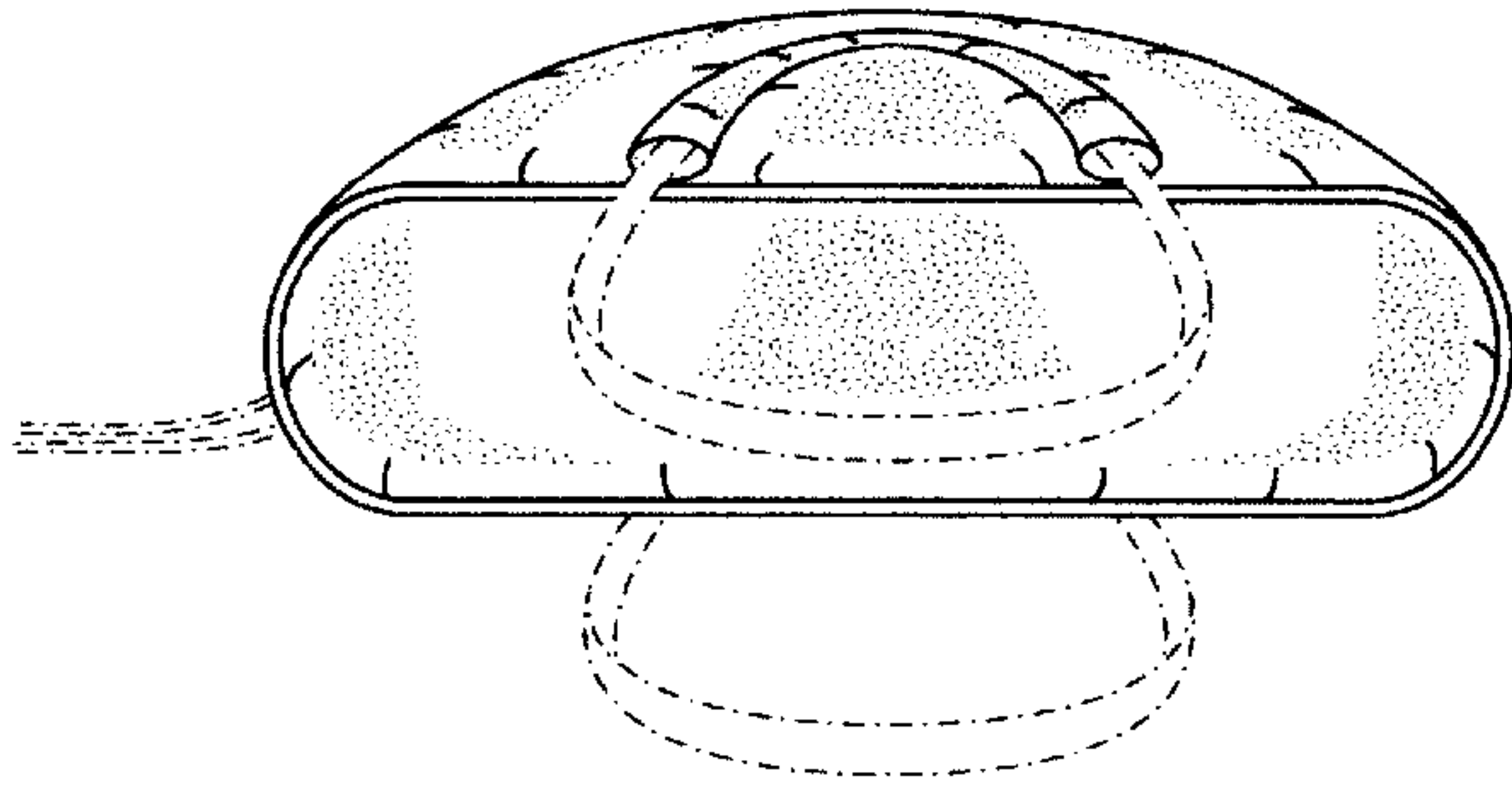

FIG. 13

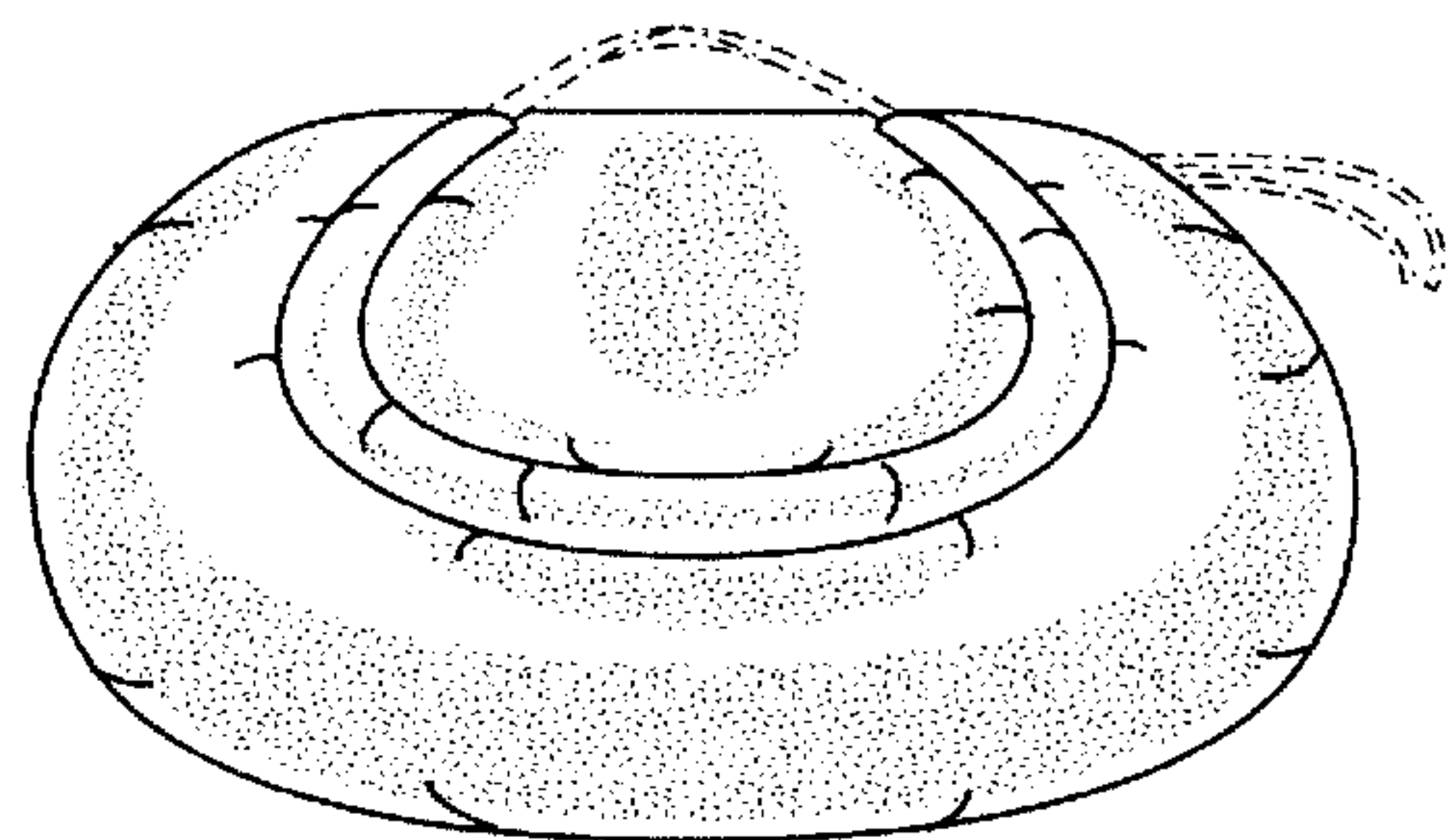

FIG. 14

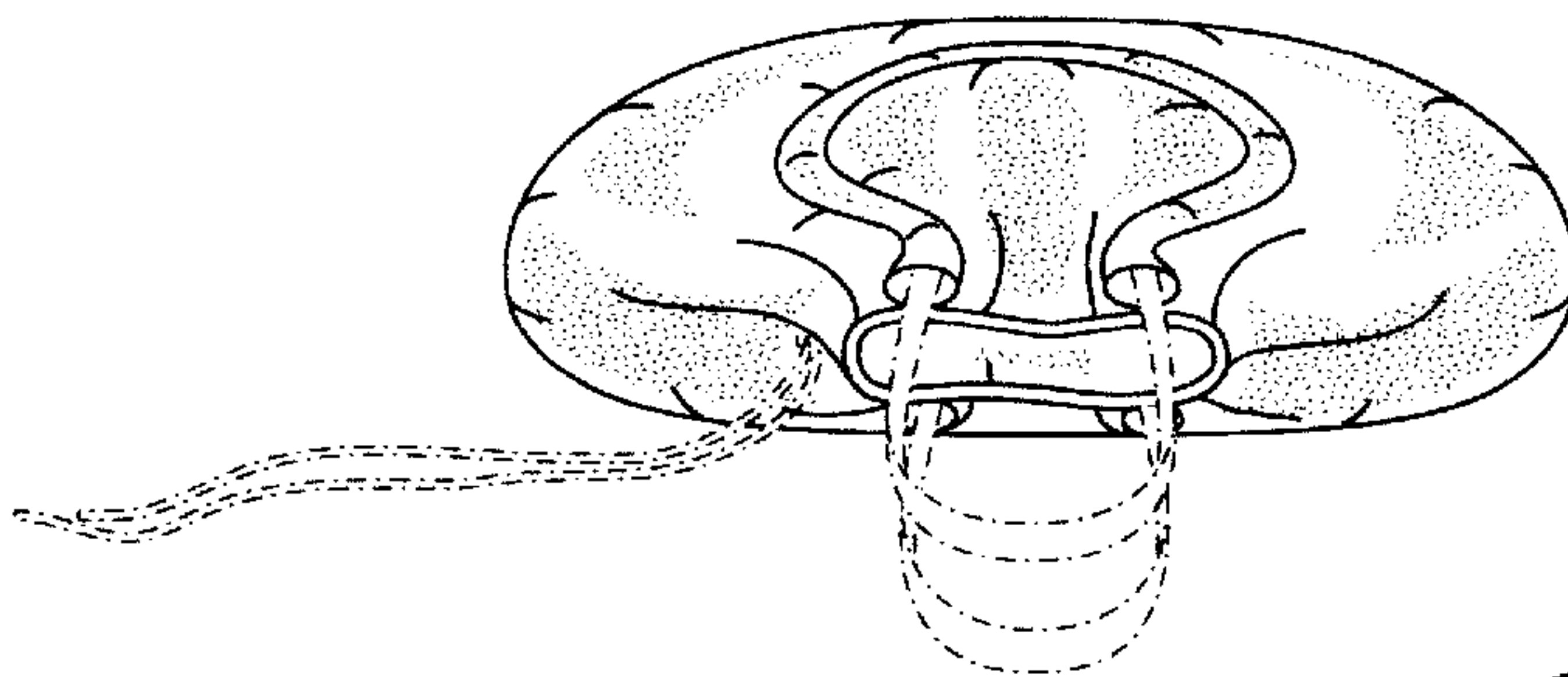

FIG. 15

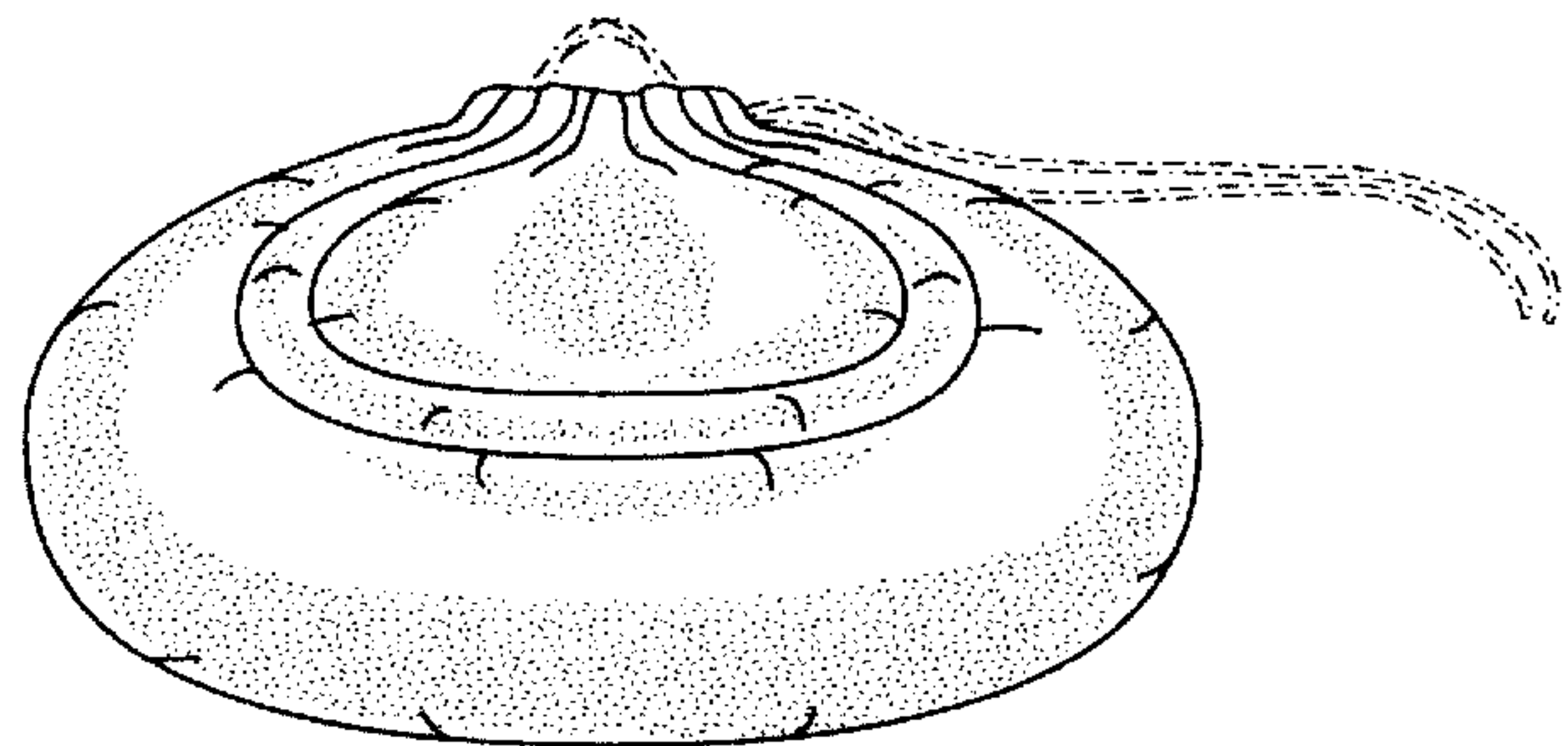

FIG. 16