



US00D488257S

(12) **United States Design Patent**
Minami

(10) **Patent No.:** **US D488,257 S**

(45) **Date of Patent:** **** Apr. 6, 2004**

(54) **AUTOMATIC HAIR WASHER**

(75) **Inventor:** **Nobuyuki Minami, Osaka (JP)**

(73) **Assignee:** **Oohiro Works, Ltd. (JP)**

(**) **Term:** **14 Years**

(21) **Appl. No.:** **29/150,755**

(22) **Filed:** **Nov. 28, 2001**

(30) **Foreign Application Priority Data**

Jun. 11, 2001 (JP) 2001-017012

(51) **LOC (7) Cl.** **28-03**

(52) **U.S. Cl.** **D28/20**

(58) **Field of Search** **D28/20; 4/515-523**

(56) **References Cited**

U.S. PATENT DOCUMENTS

5,906,012 A * 5/1999 Sakane et al. 4/519
6,243,888 B1 * 6/2001 Shimizu 4/515

* cited by examiner

Primary Examiner—Jennifer Rivard
(74) *Attorney, Agent, or Firm*—Wall Marjama & Bilinski LLP

(57) **CLAIM**

The ornamental design for an automatic hair washer, as shown and described.

DESCRIPTION

FIG. 1 is a front view of an automatic hair washer in accordance with my new design;
FIG. 2 is a back view thereof;
FIG. 3 is a left side view thereof;
FIG. 4 is a right side view thereof;
FIG. 5 is a top view thereof;
FIG. 6 is a bottom view thereof; and,
FIG. 7 is a perspective view thereof.
The broken line environmental showing is for illustrative purposes only and forms no part of the claimed design.

1 Claim, 4 Drawing Sheets

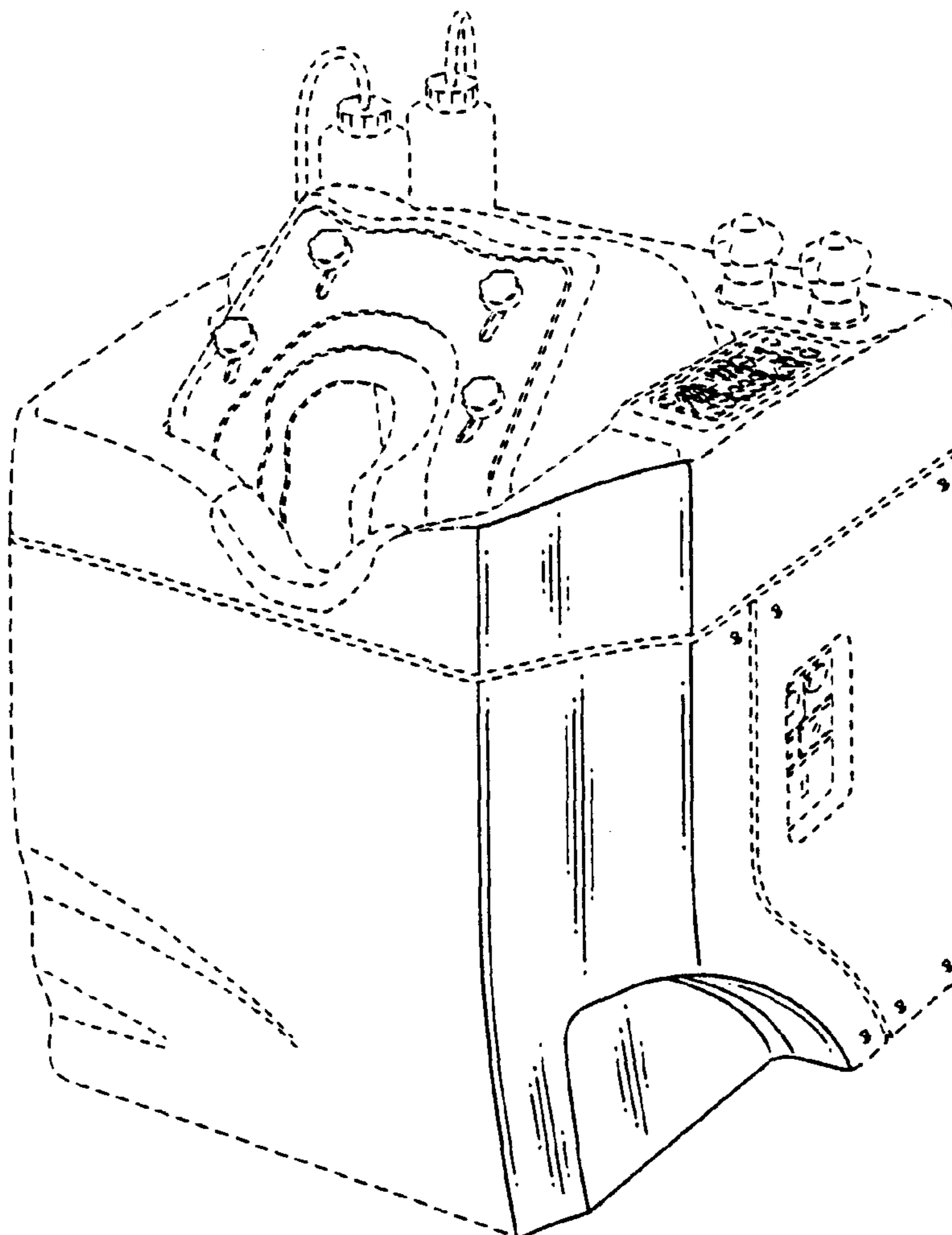

Fig.1

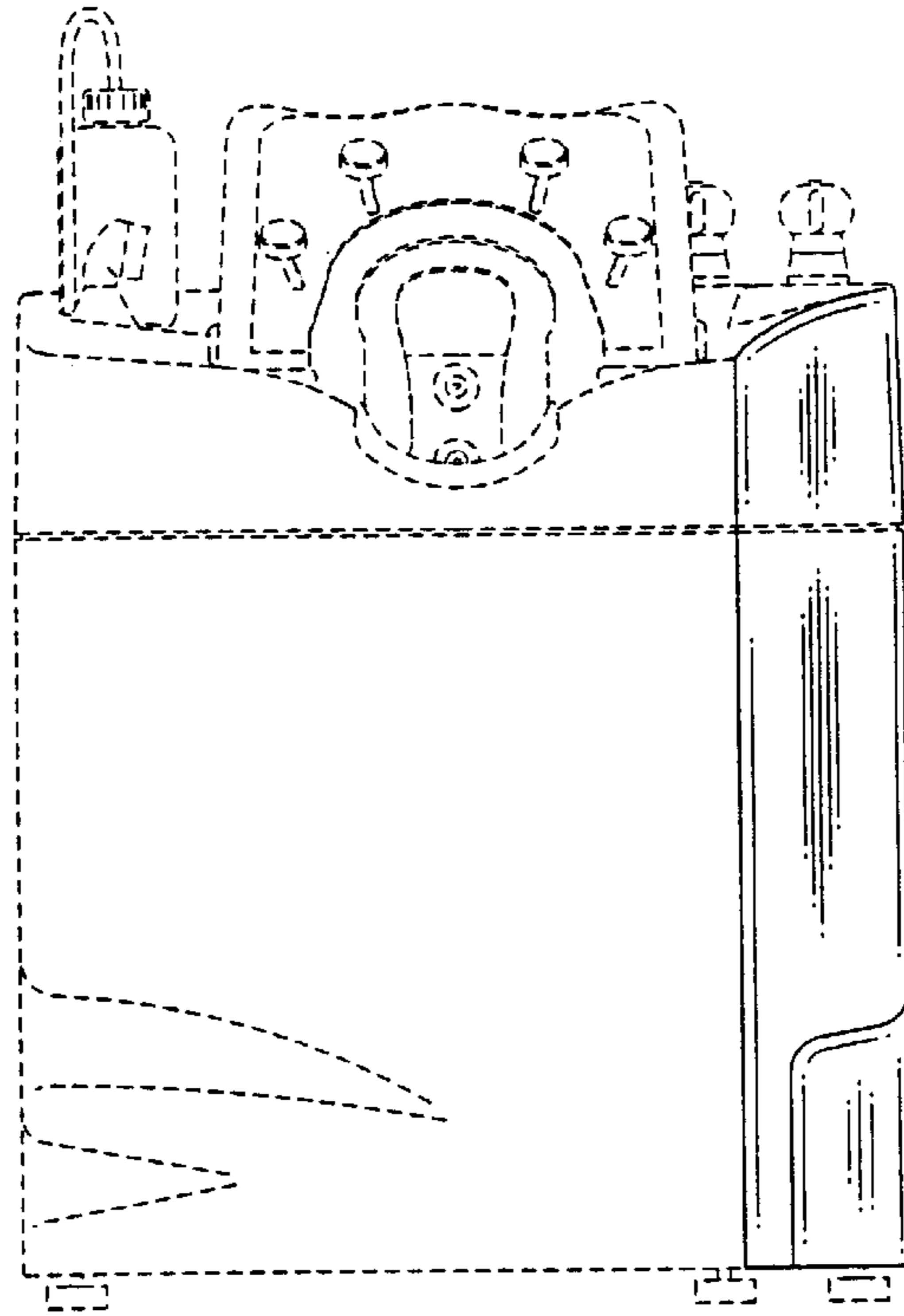

Fig.2

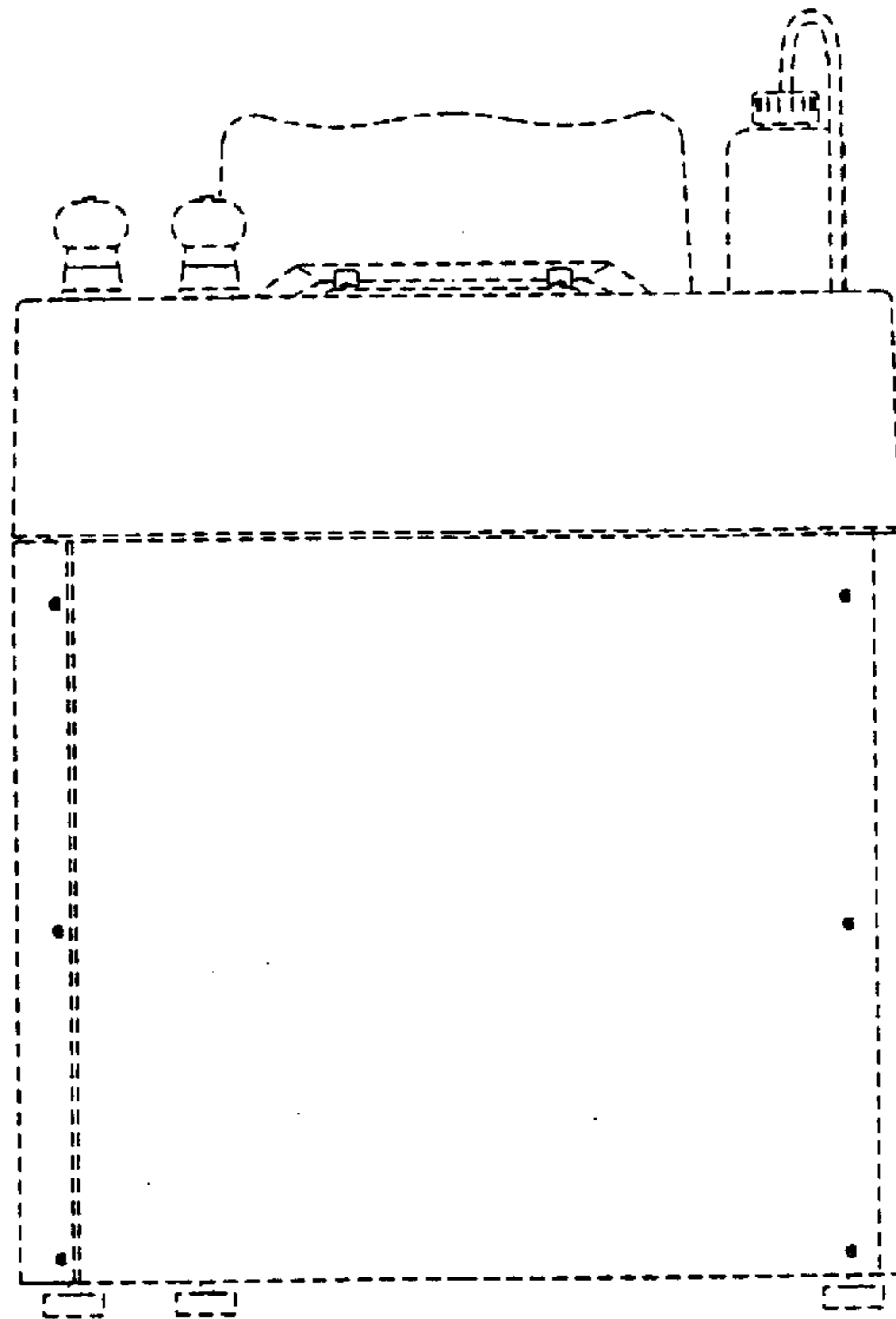

Fig.3

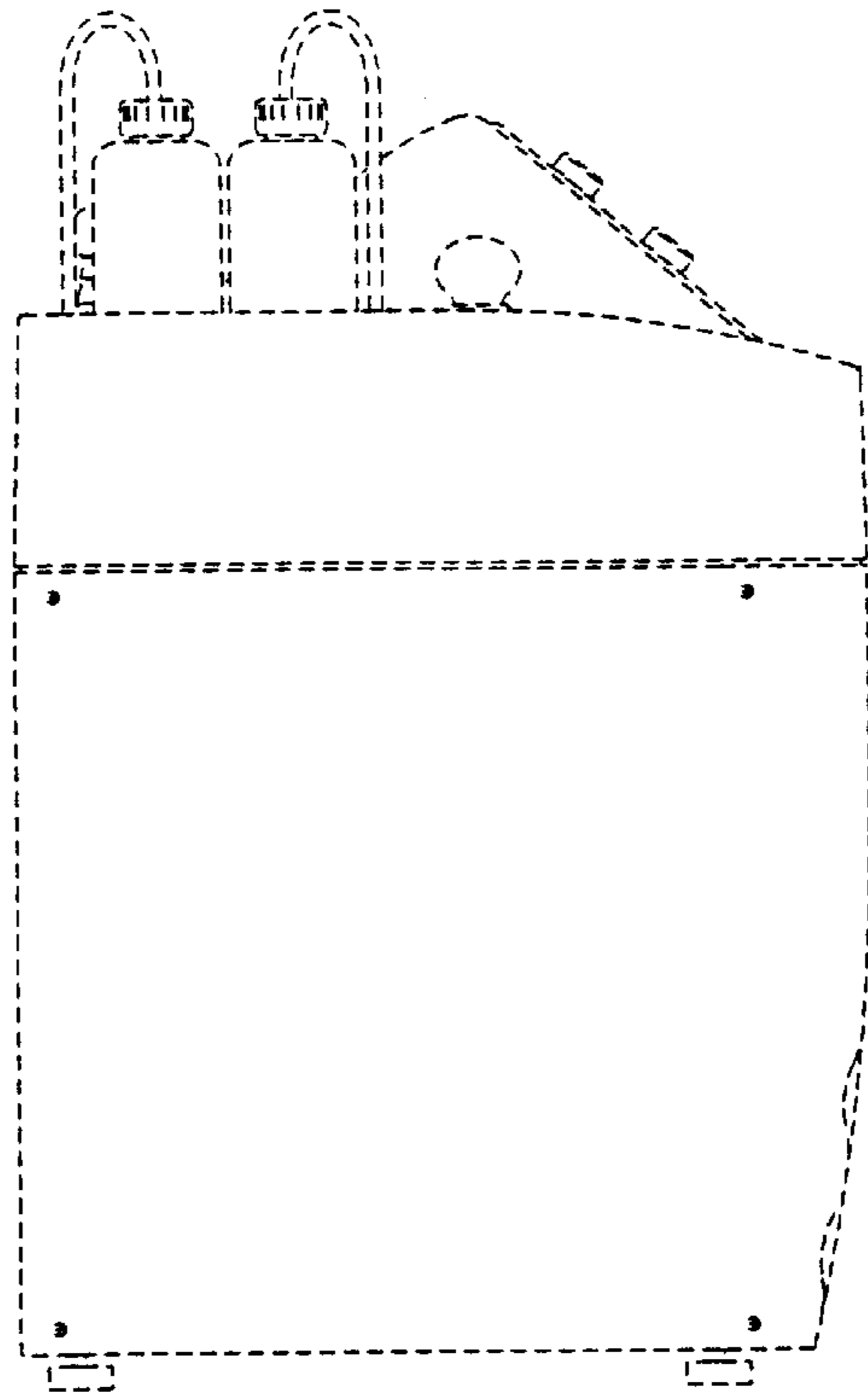

Fig.4

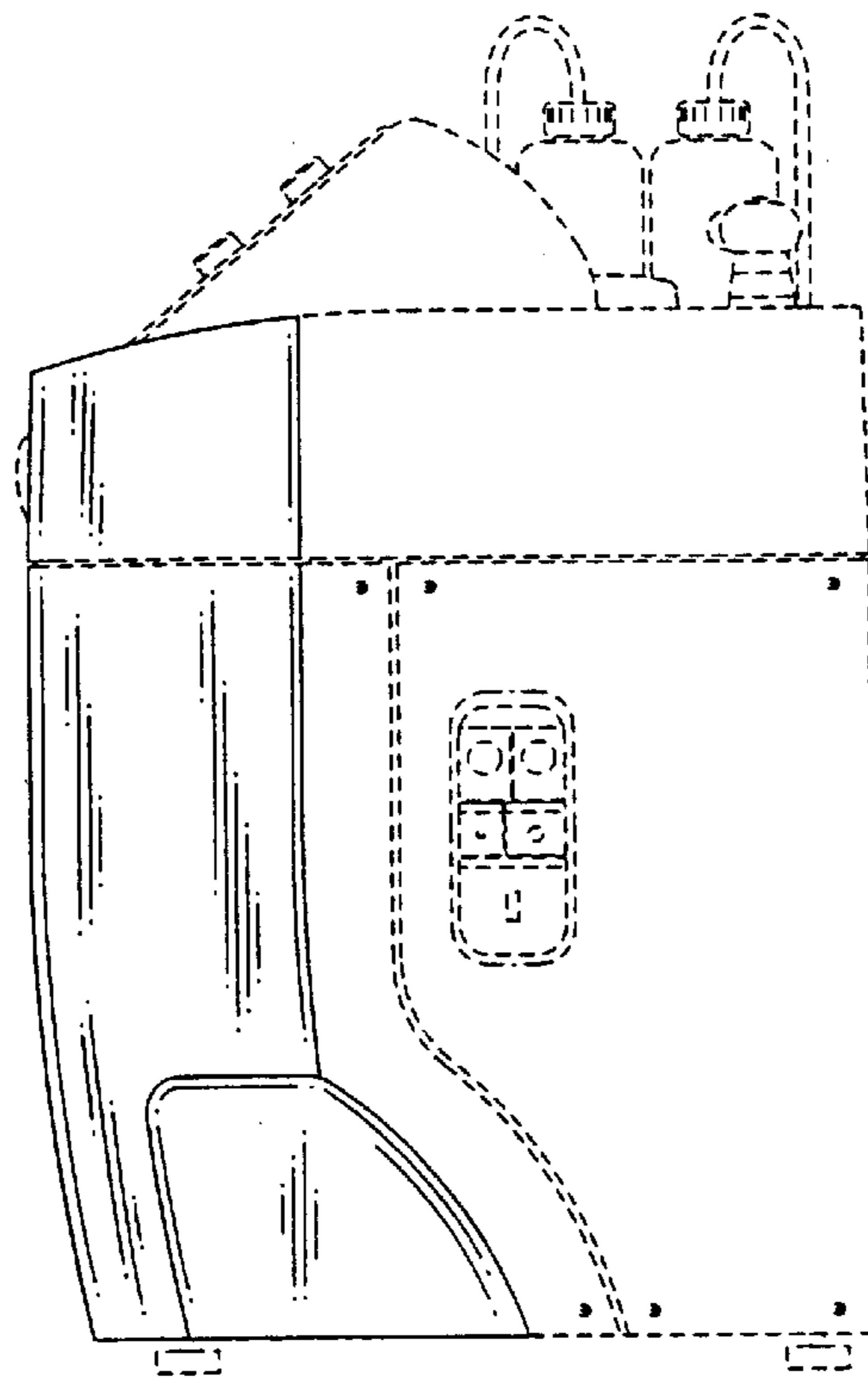

Fig.5

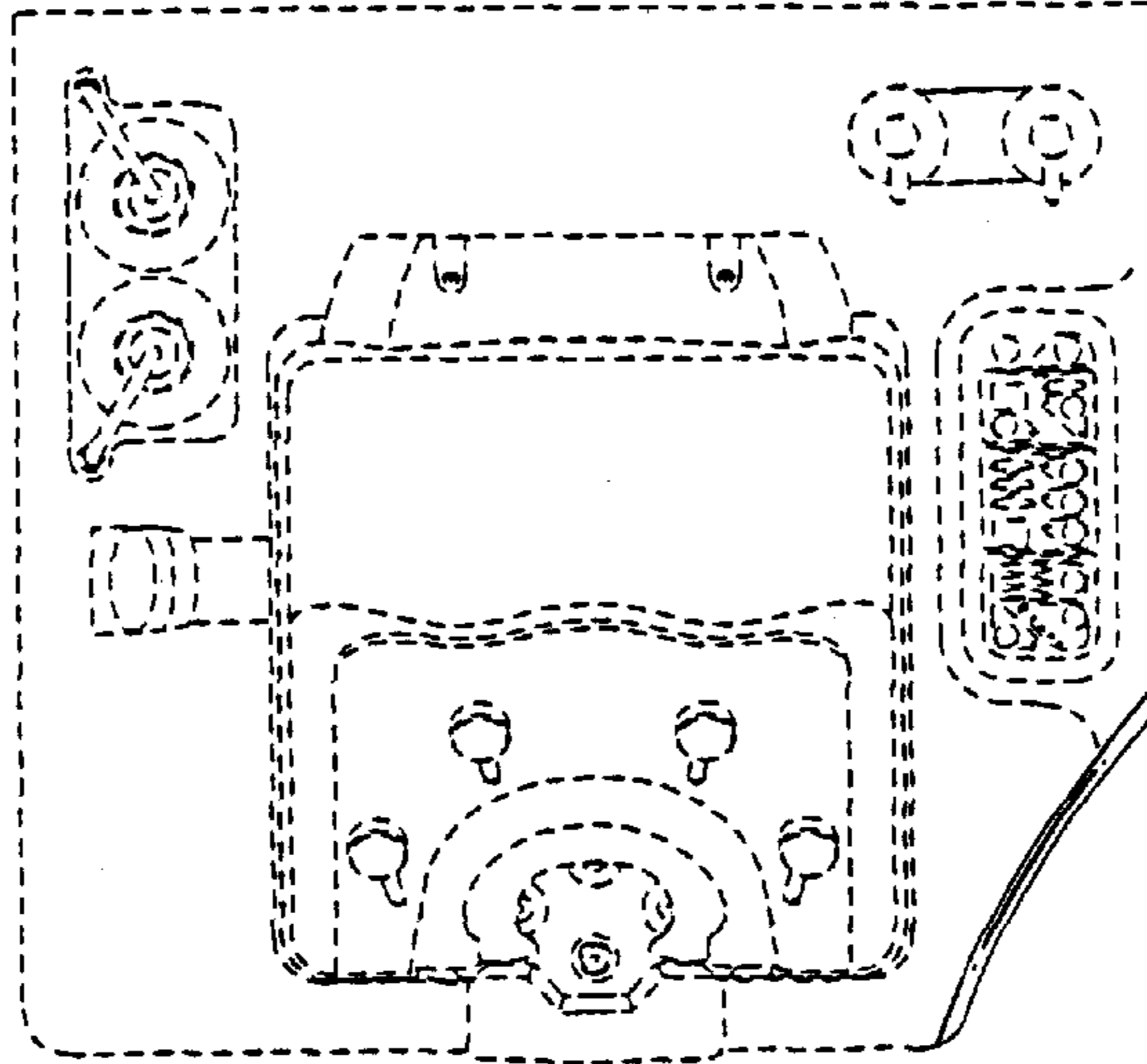

Fig.6

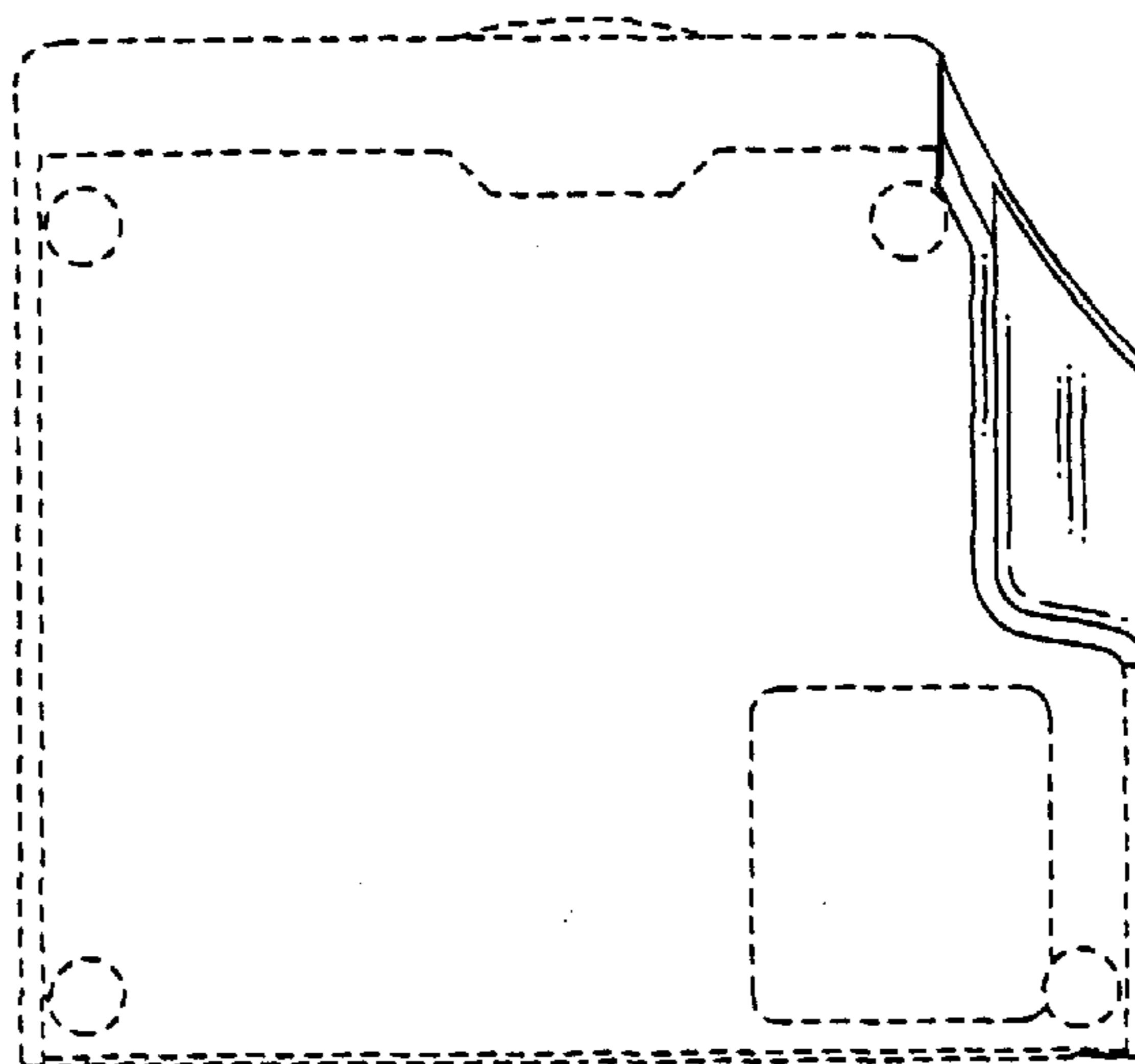

Fig.7

