



US00D488211S

(12) **United States Design Patent**
Lord

(10) **Patent No.:** **US D488,211 S**

(45) **Date of Patent:** **** Apr. 6, 2004**

(54) **PULL-OUT FAUCET**

(75) Inventor: **Judd A. Lord**, Carmel, IN (US)

(73) Assignee: **Masco Corporation of Indiana**,
Indianapolis, IN (US)

(**) Term: **14 Years**

(21) Appl. No.: **29/178,020**

(22) Filed: **Mar. 20, 2003**

(51) **LOC (7) Cl.** **23-01**

(52) **U.S. Cl.** **D23/255; D23/223**

(58) **Field of Search** **D23/238-243,**
D23/250-257; 4/675-678; 137/801

(56) **References Cited**

U.S. PATENT DOCUMENTS

D367,700 S * 3/1996 Hill et al. D23/255
D385,338 S * 10/1997 Burchard et al. D23/255
D477,861 S * 7/2003 Lord D23/255

* cited by examiner

Primary Examiner—Louis S. Zarfaz

Assistant Examiner—Gregory Andoll

(74) *Attorney, Agent, or Firm*—Kwadjo Adusei-Poku;
Lloyd D. Doigan

(57) **CLAIM**

The ornamental design for a pull-out faucet, as shown and described.

DESCRIPTION

FIG. 1 is a front perspective view of a pull-out faucet showing my new design;

FIG. 2 is a rear perspective view thereof;

FIG. 3 is a right side elevational view thereof;

FIG. 4 is a left side elevational view thereof;

FIG. 5 is a top plan view thereof;

FIG. 6 is a front elevational view thereof;

FIG. 7 is a rear elevational view thereof; and,

FIG. 8 is a bottom plan view thereof.

The broken lines in the Figures are for illustrative purposes only and form no part of the claimed design.

1 Claim, 7 Drawing Sheets

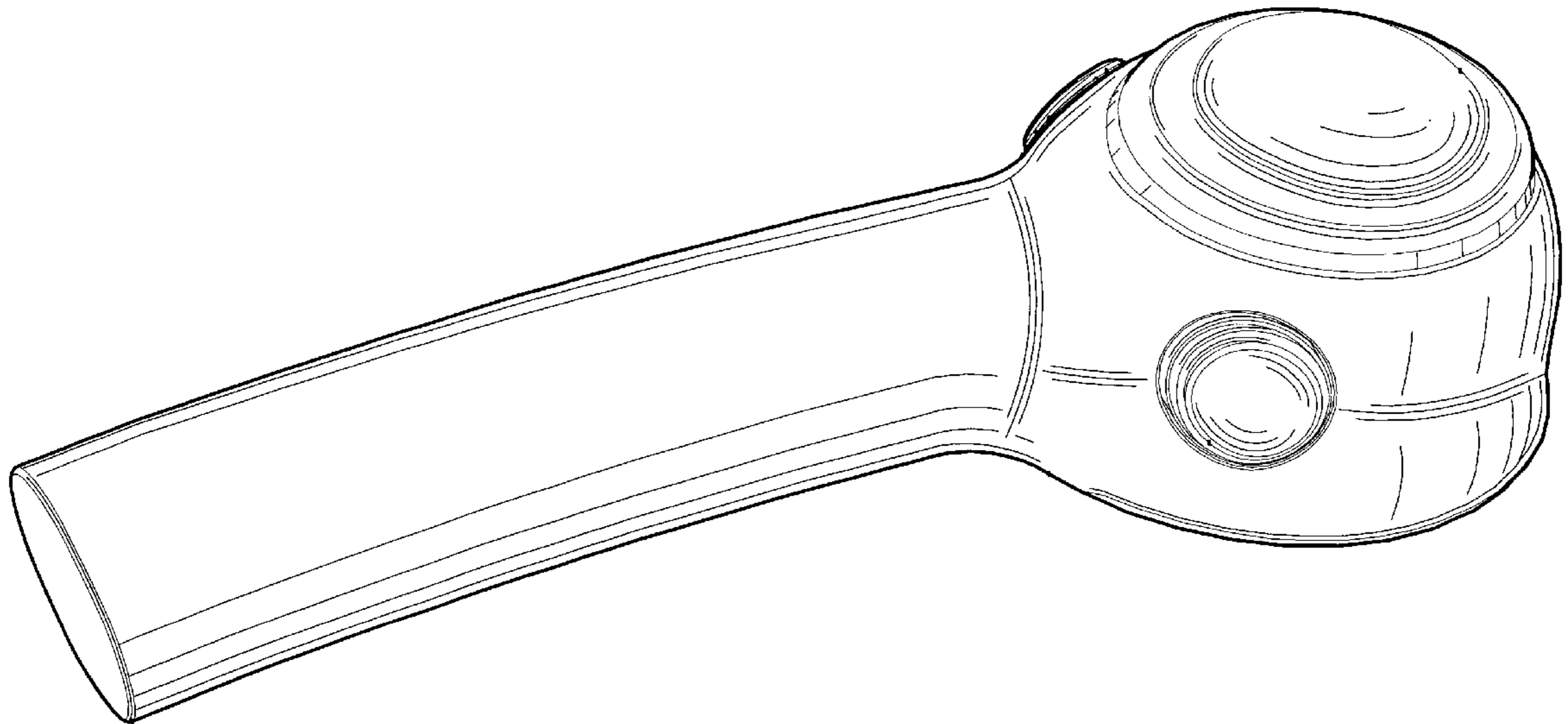

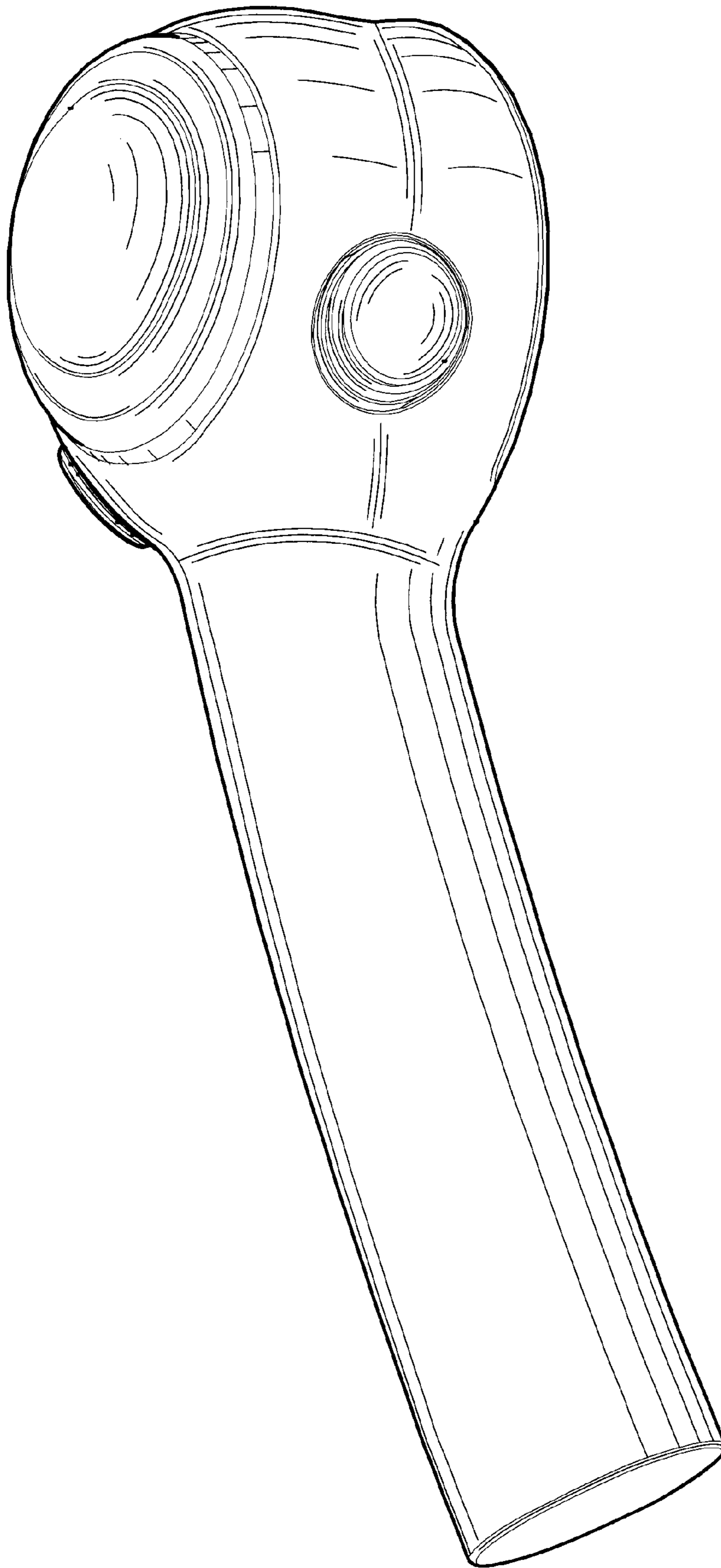

FIG - 1

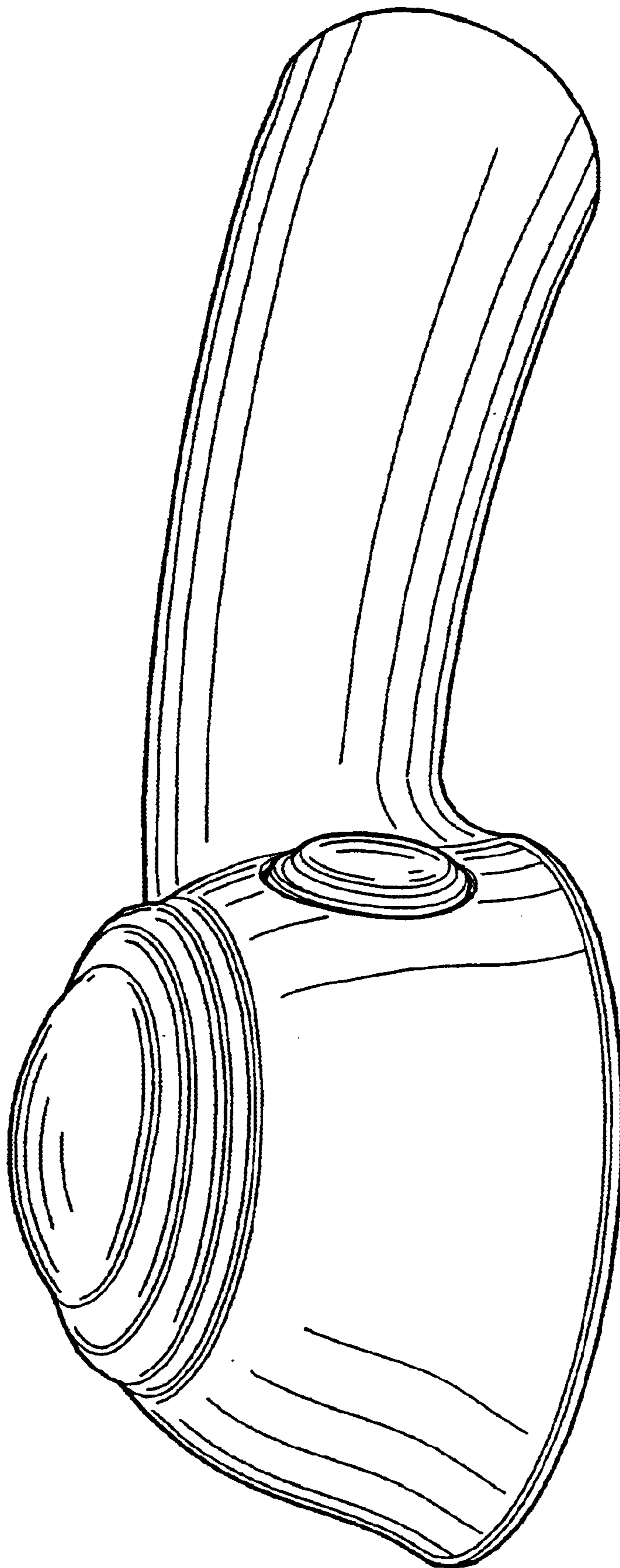

FIG - 2

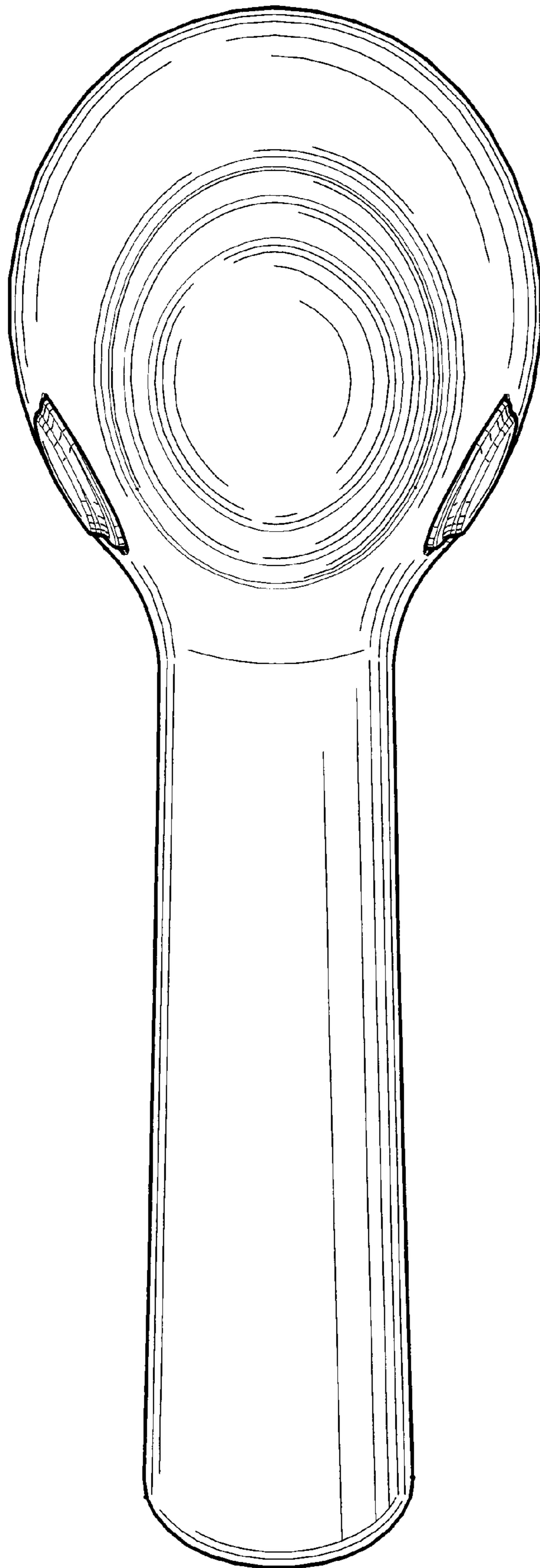

FIG - 3

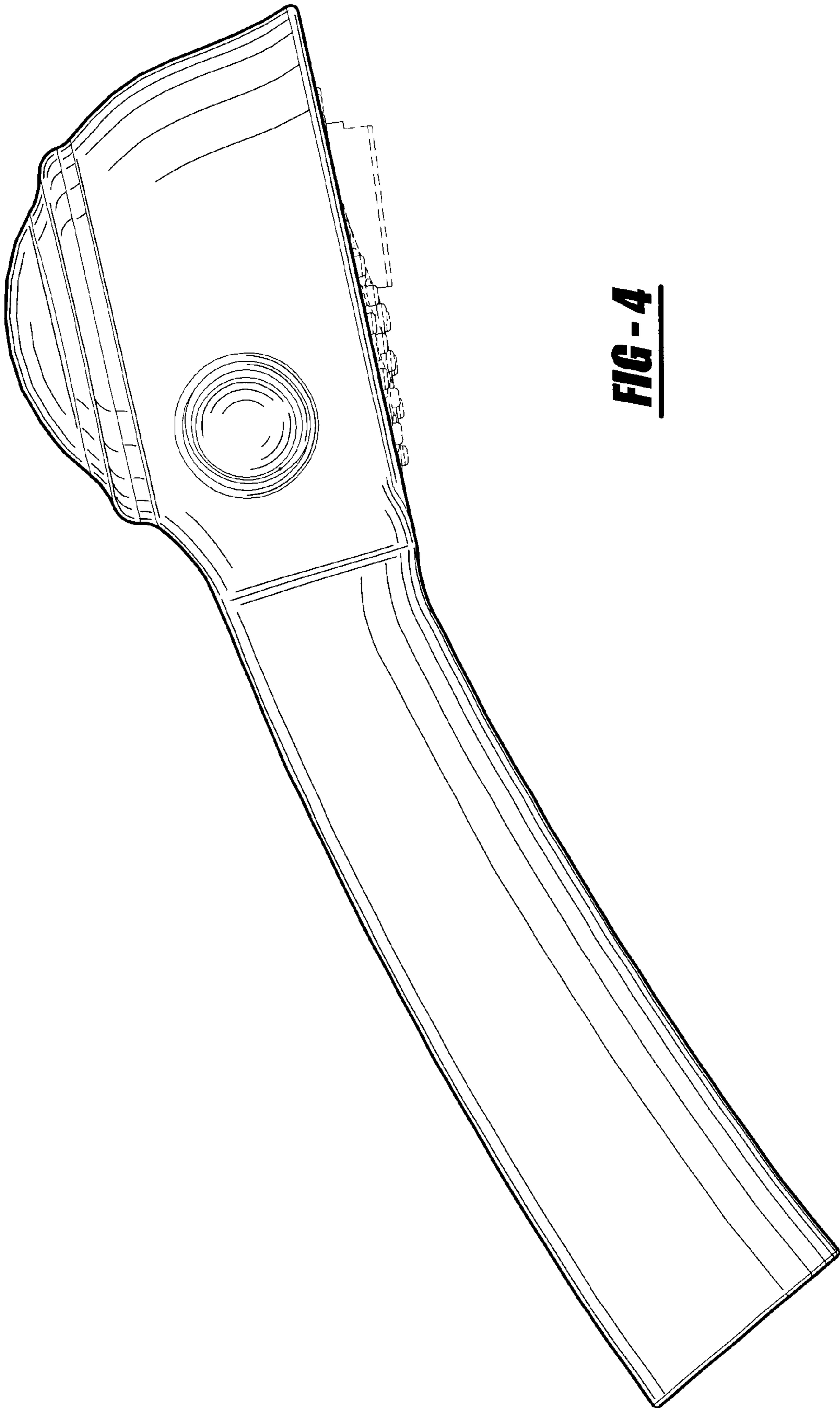

FIG - 4

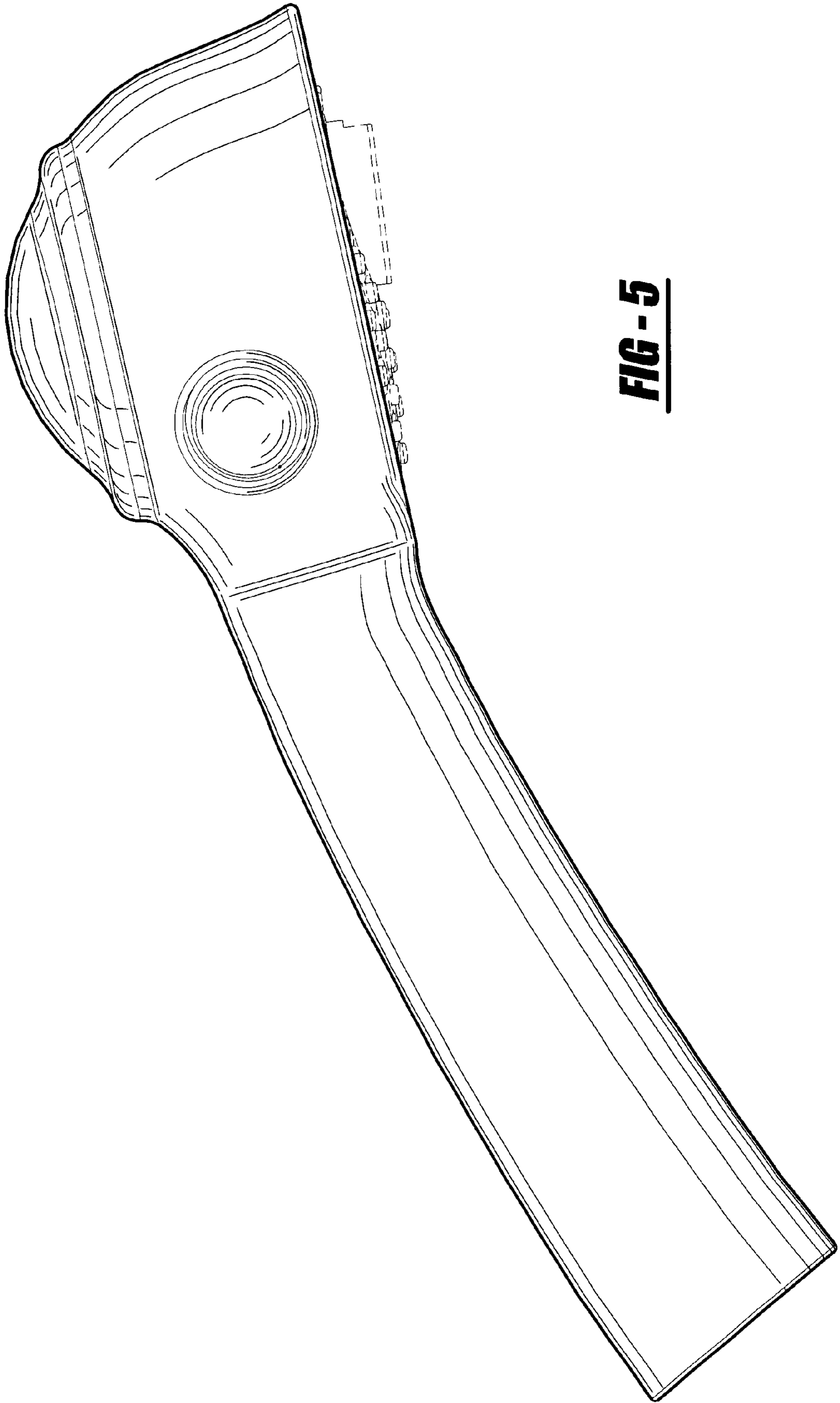

FIG - 5

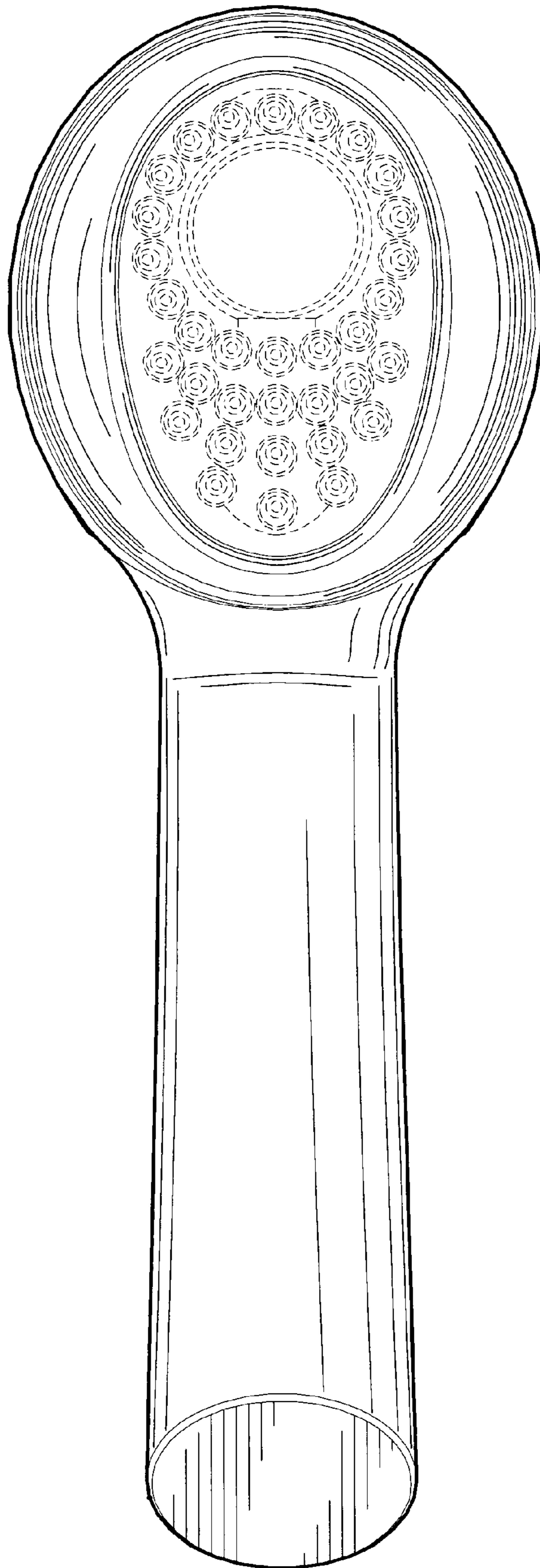

FIG - 6

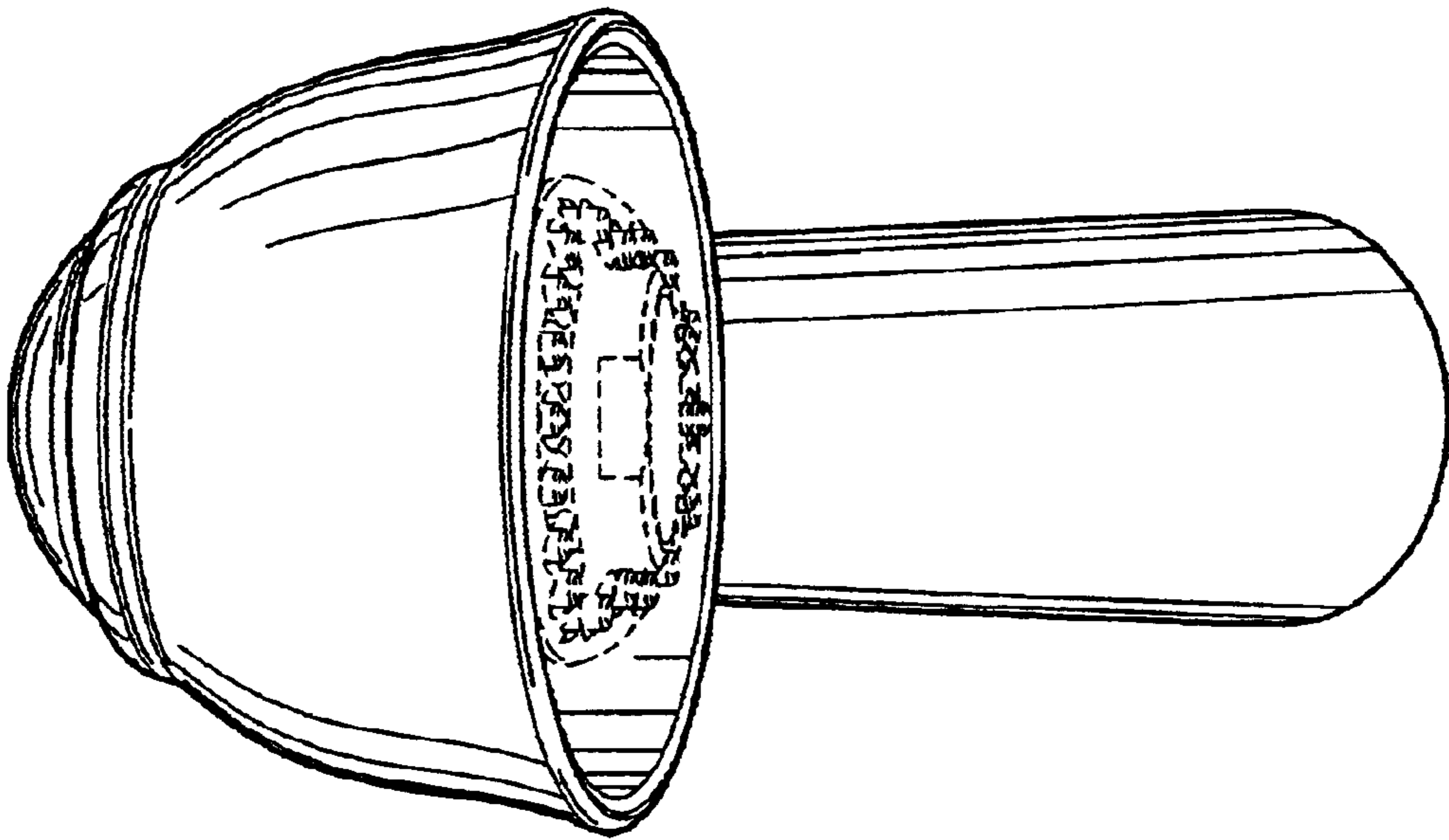

FIG - 8

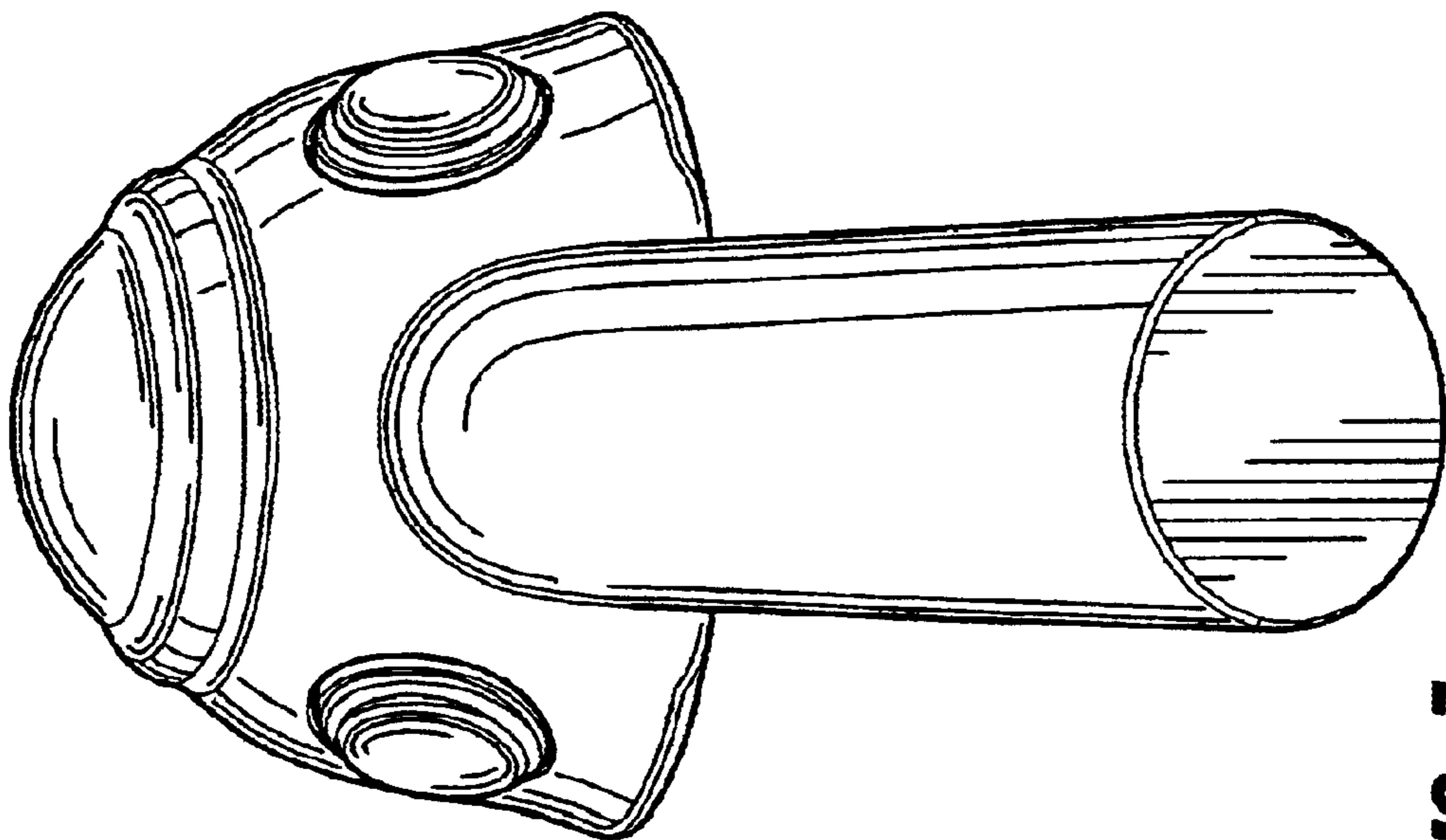

FIG - 7