



US00D488210S

(12) **United States Design Patent** (10) **Patent No.:** **US D488,210 S**
Lord (45) **Date of Patent:** **** Apr. 6, 2004**

(54) **KITCHEN FAUCET**
(75) Inventor: **Judd A. Lord**, Carmel, IN (US)
(73) Assignee: **Masco Corporation of Indiana**, Indianapolis, IN (US)
(**) Term: **14 Years**
(21) Appl. No.: **29/178,096**
(22) Filed: **Mar. 20, 2003**
(51) **LOC (7) Cl.** **23-01**
(52) **U.S. Cl.** **D23/238**
(58) **Field of Search** **D23/238-257;**
4/675-678; 137/801

Primary Examiner—Louis S. Zarfaz
Assistant Examiner—Gregory Andoll
(74) *Attorney, Agent, or Firm*—Kwadjo Adusei-Poku;
Lloyd D. Doigan

(57) **CLAIM**

The ornamental design for a kitchen faucet, as shown and described.

DESCRIPTION

FIG. 1 is a front perspective view of a kitchen faucet showing my new design;
FIG. 2 is a rear perspective view thereof;
FIG. 3 is a front elevational view thereof;
FIG. 4 is a rear elevational view thereof;
FIG. 5 is a left side elevational view thereof;
FIG. 6 is a top plan view thereof;
FIG. 7 is a right side elevational view thereof; and,
FIG. 8 is a bottom plan view thereof.

The broken lines in the Figures are for illustrative purposes only and form no part of the claimed design.

(56) **References Cited**
U.S. PATENT DOCUMENTS
D433,739 S * 11/2000 Lord D23/252
D438,285 S * 2/2001 Baghera et al. D23/238
D443,337 S * 6/2001 Mark et al. D23/238
D463,529 S * 9/2002 Dretzka D23/238
D470,224 S * 2/2003 Hanna D23/238

* cited by examiner

1 Claim, 8 Drawing Sheets

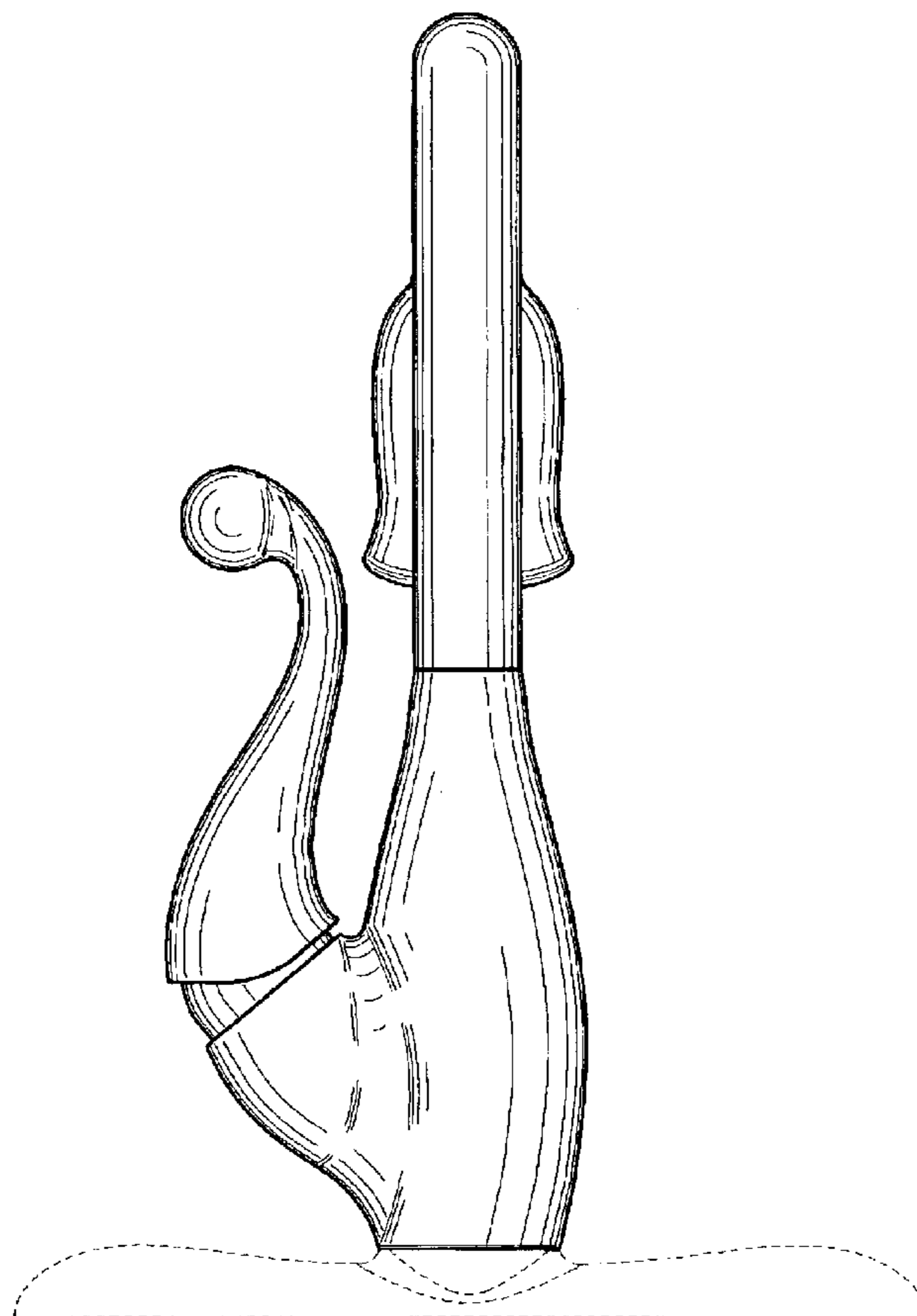

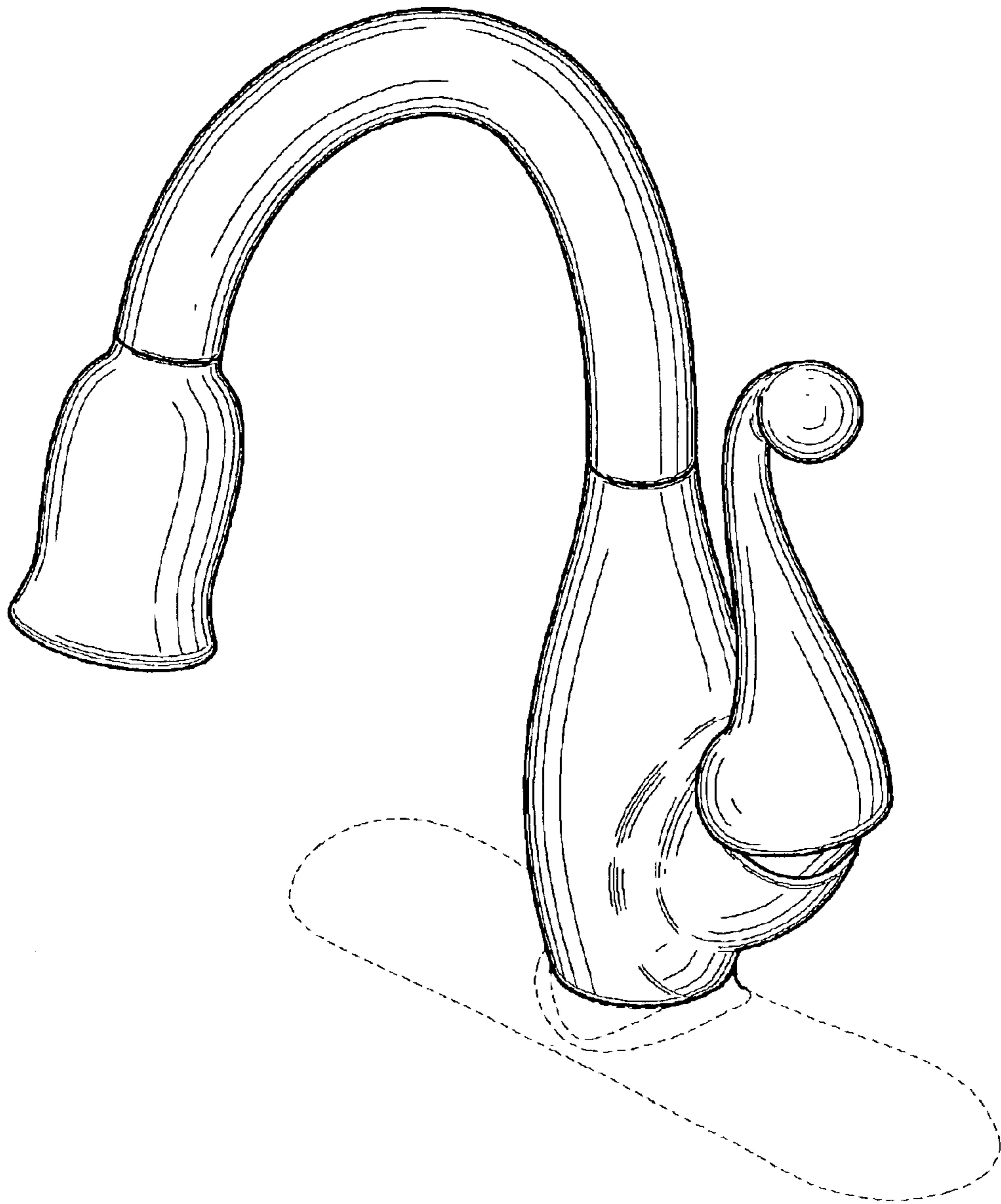

FIG-1

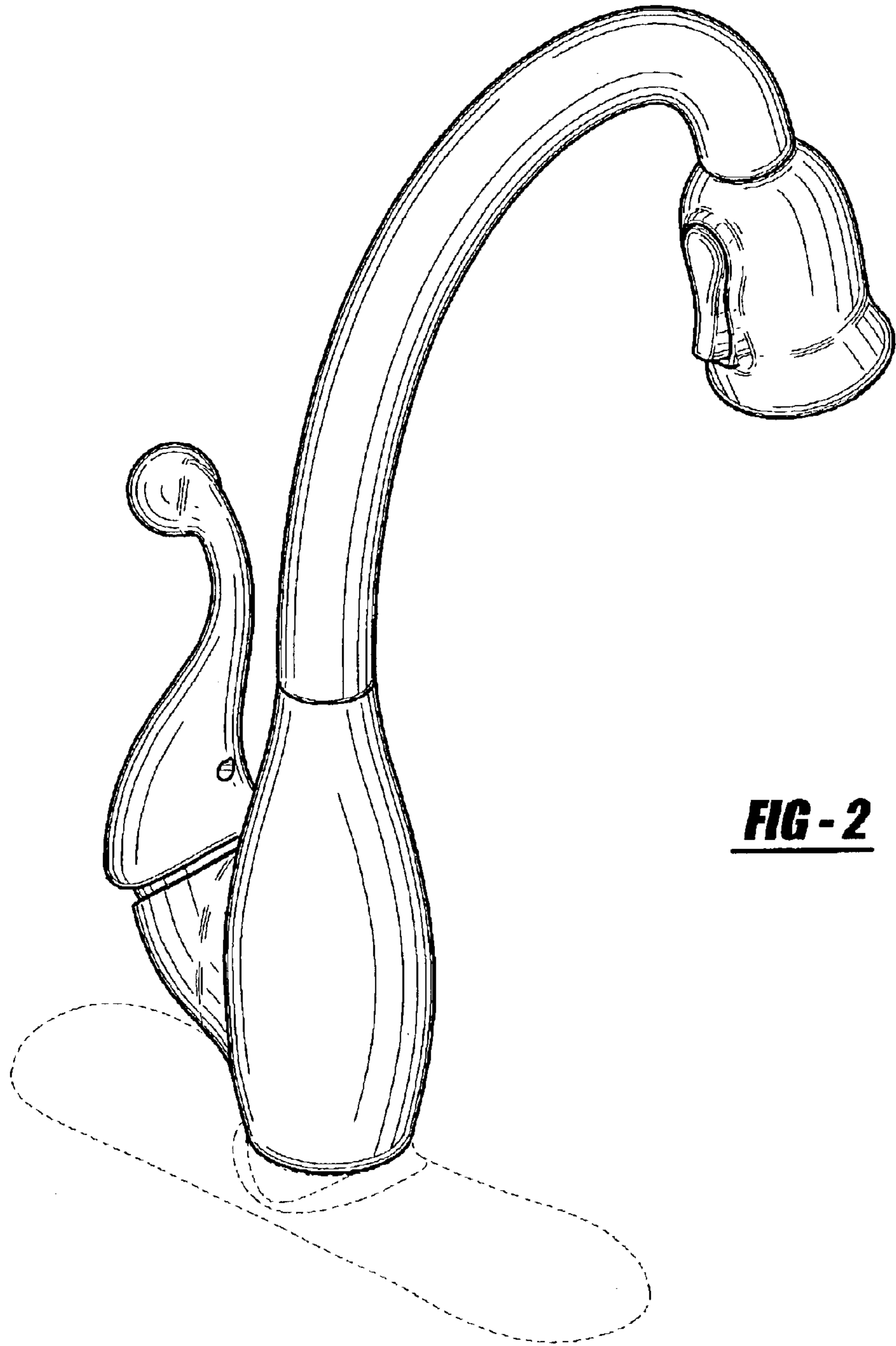

FIG - 2



FIG - 3

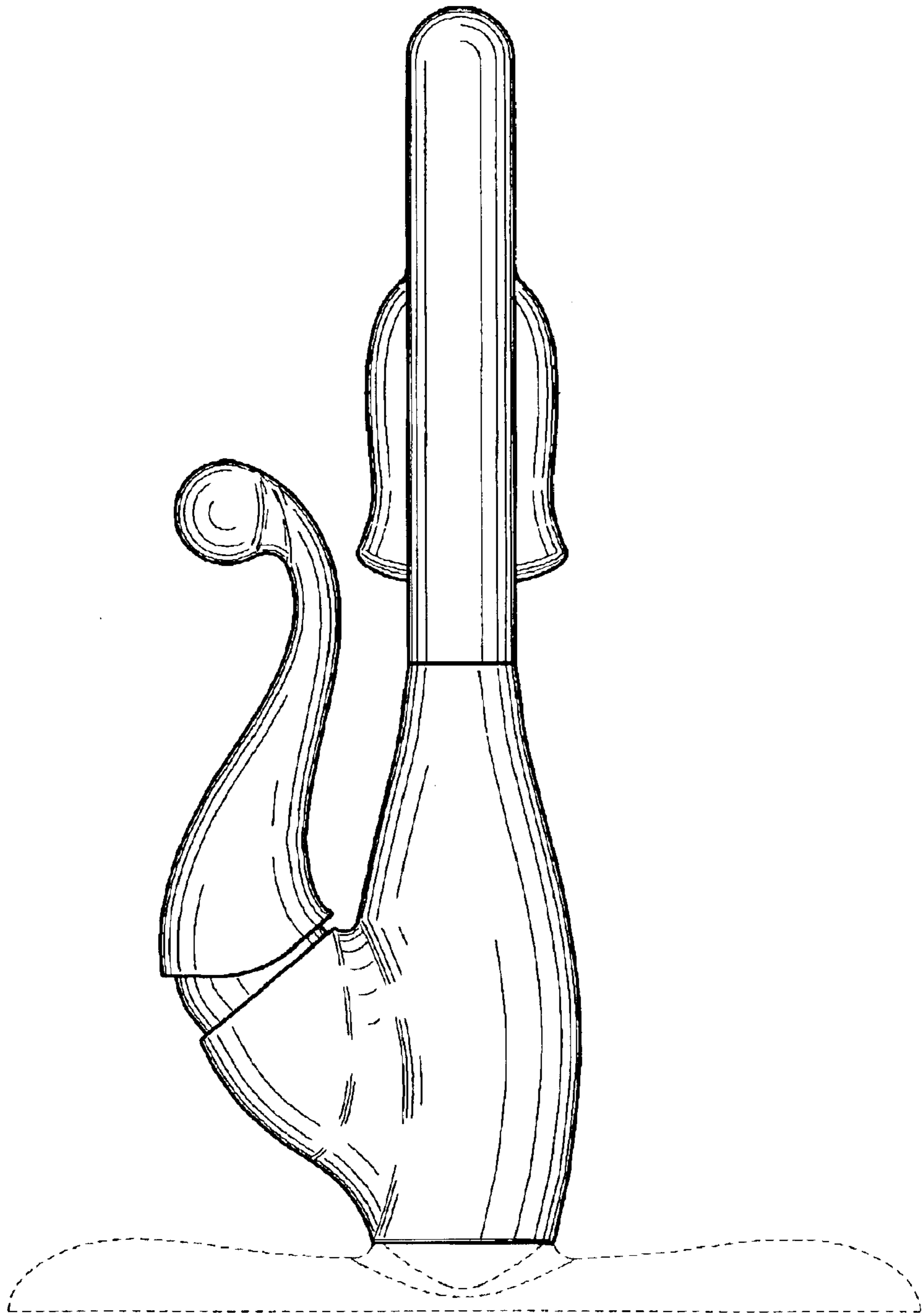

FIG - 4

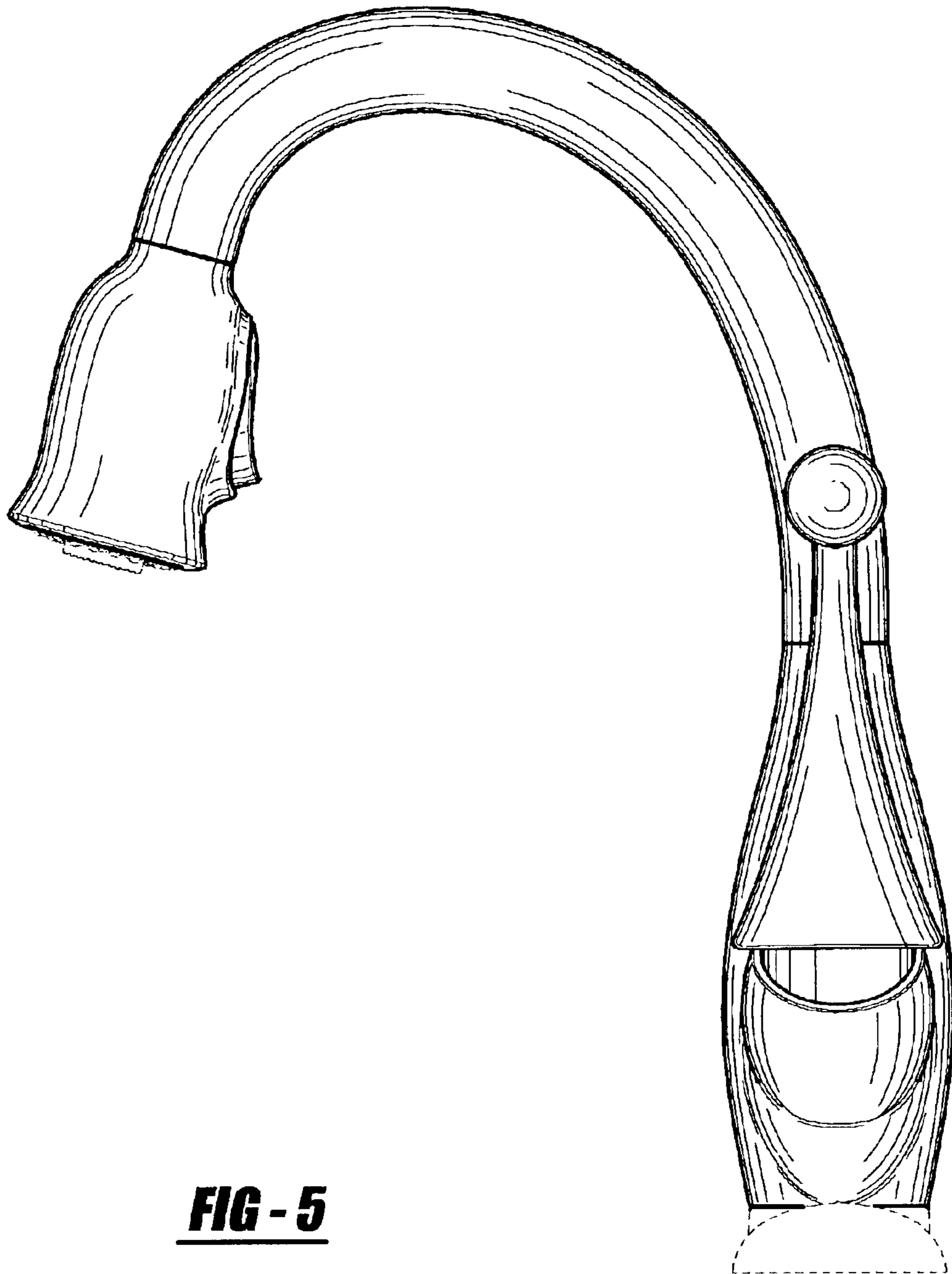

FIG - 5

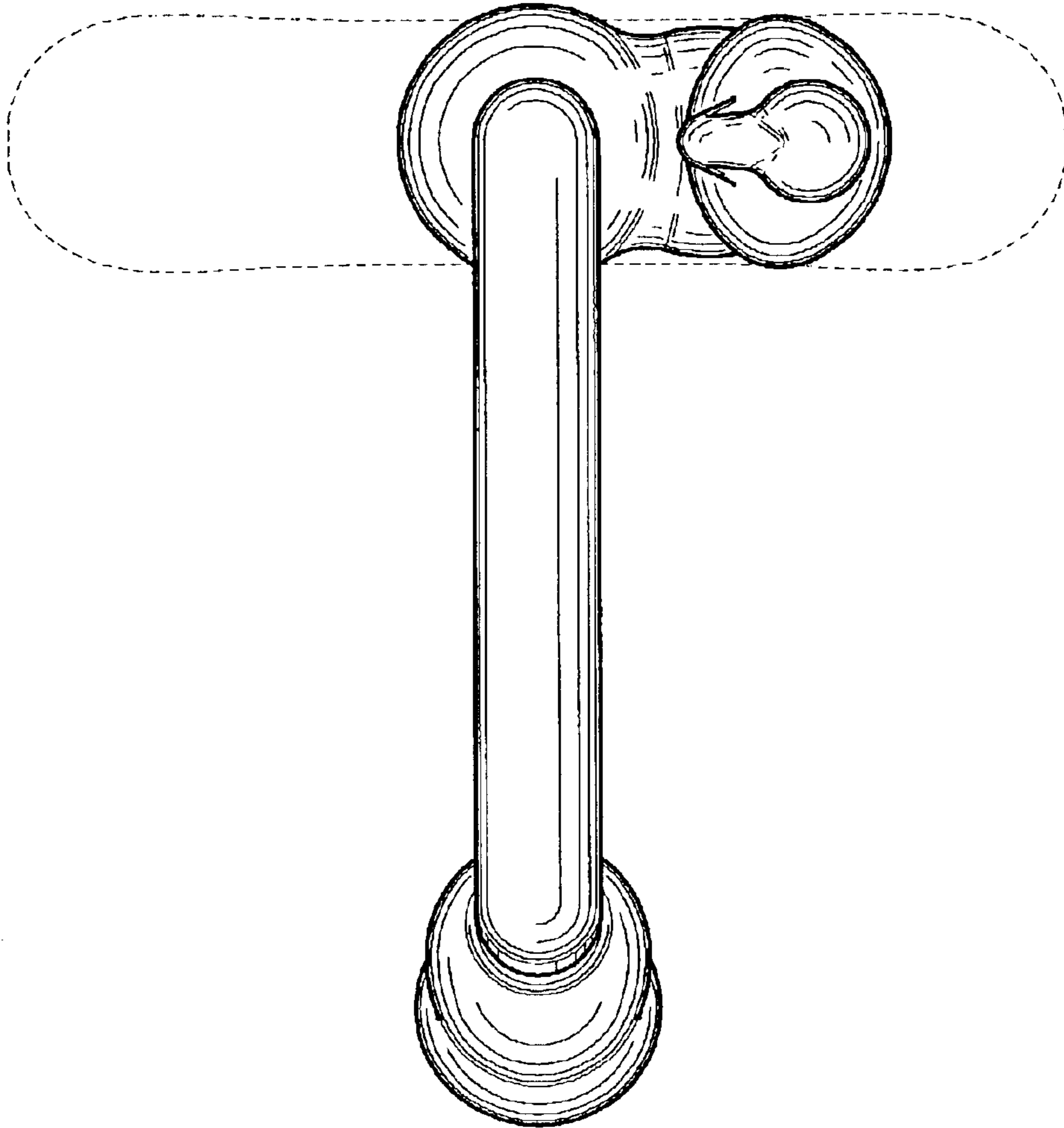

FIG - 6

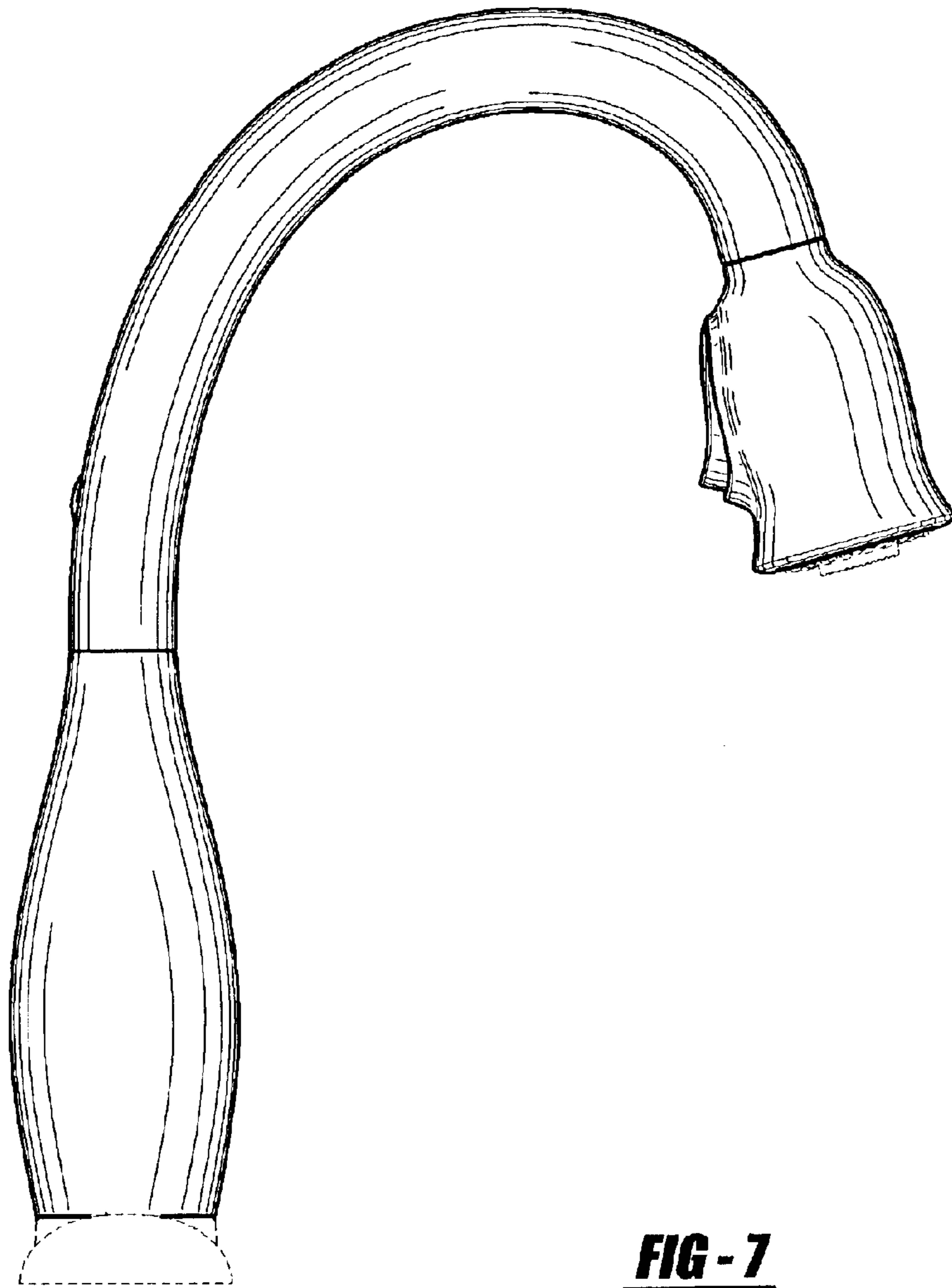

FIG - 7

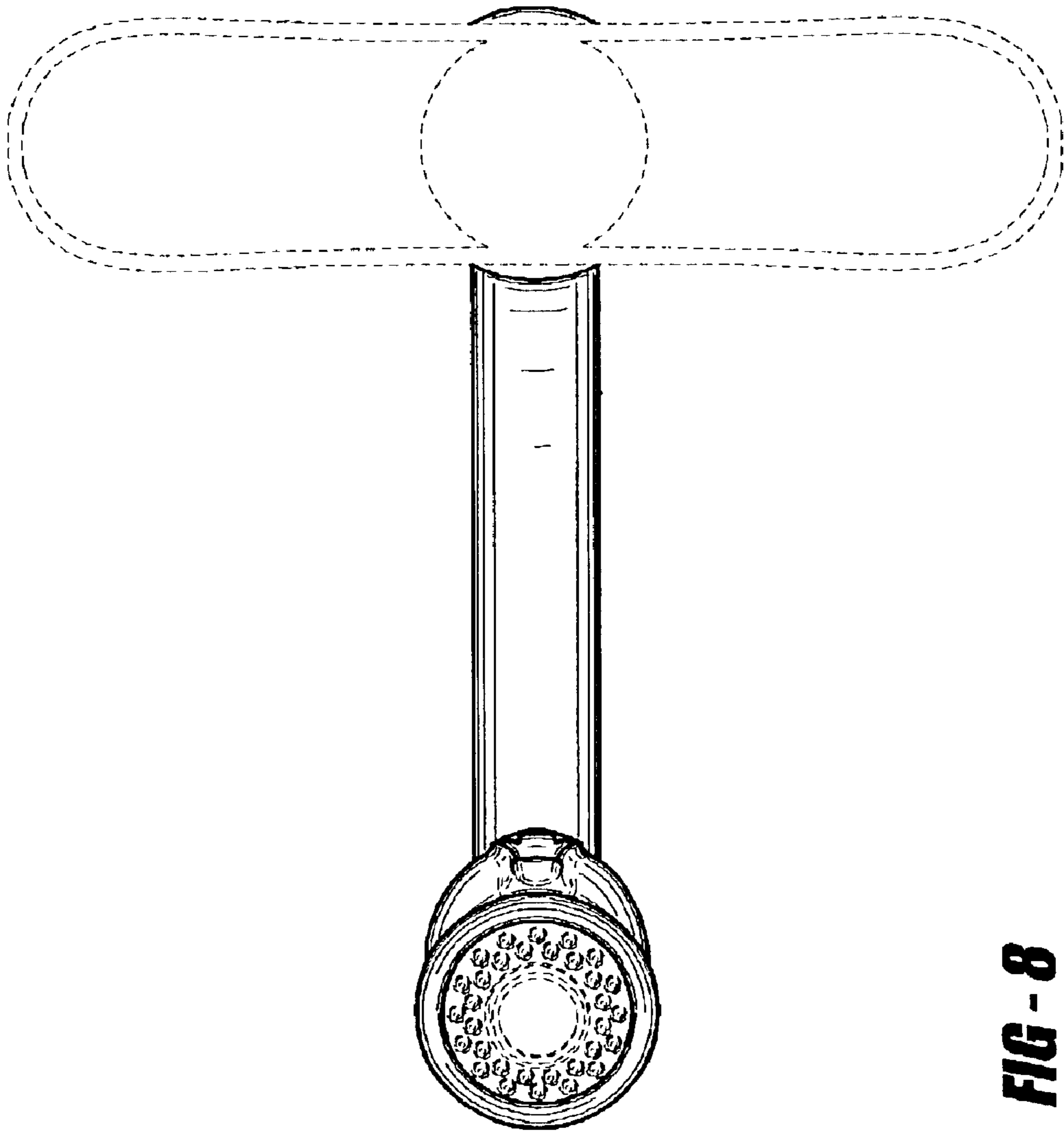

FIG - 8