



US00D488030S

(12) **United States Design Patent**
Drzymala

(10) **Patent No.:** **US D488,030 S**

(45) **Date of Patent:** **** Apr. 6, 2004**

(54) **COOLER WITH REMOVABLE CONTAINERS**

Primary Examiner—Terry A. Wallace

(76) **Inventor:** **Frances M. Drzymala**, 4810 Sipple Ave., Baltimore, MD (US) 21206

(**) **Term:** **14 Years**

(21) **Appl. No.:** **29/183,879**

(22) **Filed:** **Jun. 19, 2003**

(51) **LOC (7) Cl.** **07-01**

(52) **U.S. Cl.** **D7/605; D7/709**

(58) **Field of Search** D7/605–608, 629, D7/709, 710; D3/295, 201, 203, 205, 206, 273; 62/457.1–457.7, 371, 372; 206/216, 223, 541, 542, 545, 549; 220/592.16, 592.17, 592.2, 592.23–592.27, 915.1, 915.2

(56) **References Cited**

U.S. PATENT DOCUMENTS

D302,904 S	*	8/1989	Dunkfeld, Jr.	D7/709
5,671,846 A	*	9/1997	Frank	206/541
6,112,899 A	*	9/2000	Zeringue	206/541
D472,774 S	*	4/2003	Pelstring et al.	D7/629

* cited by examiner

(57) **CLAIM**

The ornamental design for a cooler with removable containers, as shown and described.

DESCRIPTION

FIG. 1 is a front elevated view of a cooler with removable containers showing my new design;
 FIG. 2 is a rear elevated view of the cooler with removable containers;
 FIG. 3 is a right side elevated view of the cooler with removable containers;
 FIG. 4 is a left side elevated view of the cooler with removable containers;
 FIG. 5 is a top plan view of the cooler with removable containers; and
 FIG. 6 is a bottom plan view of the cooler with removable containers; and,
 FIG. 7 is a perspective view of the cooler with removable containers.

1 Claim, 4 Drawing Sheets

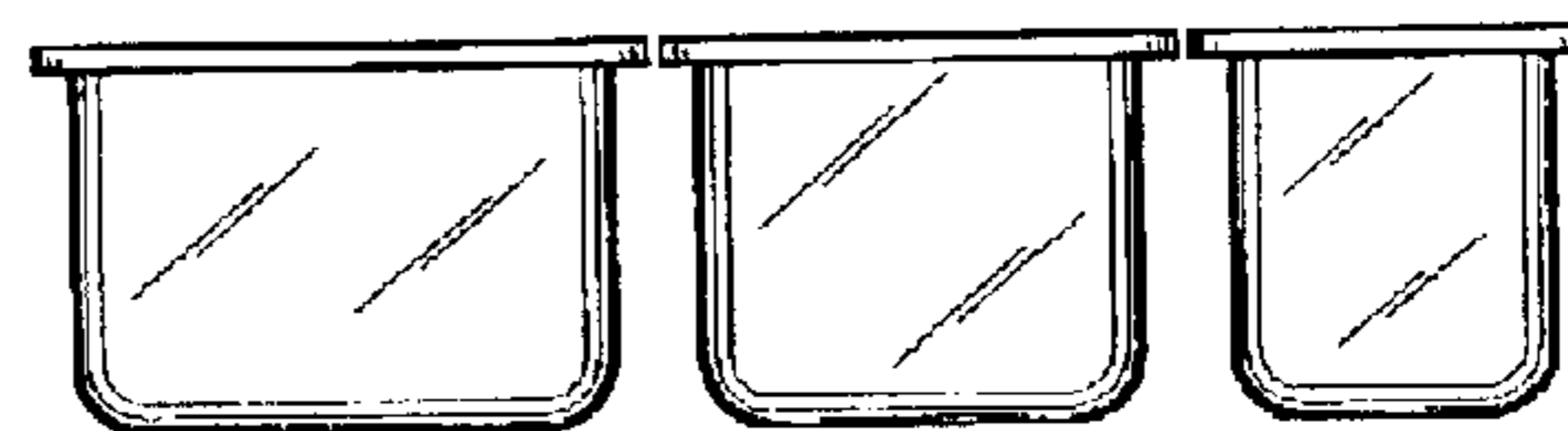
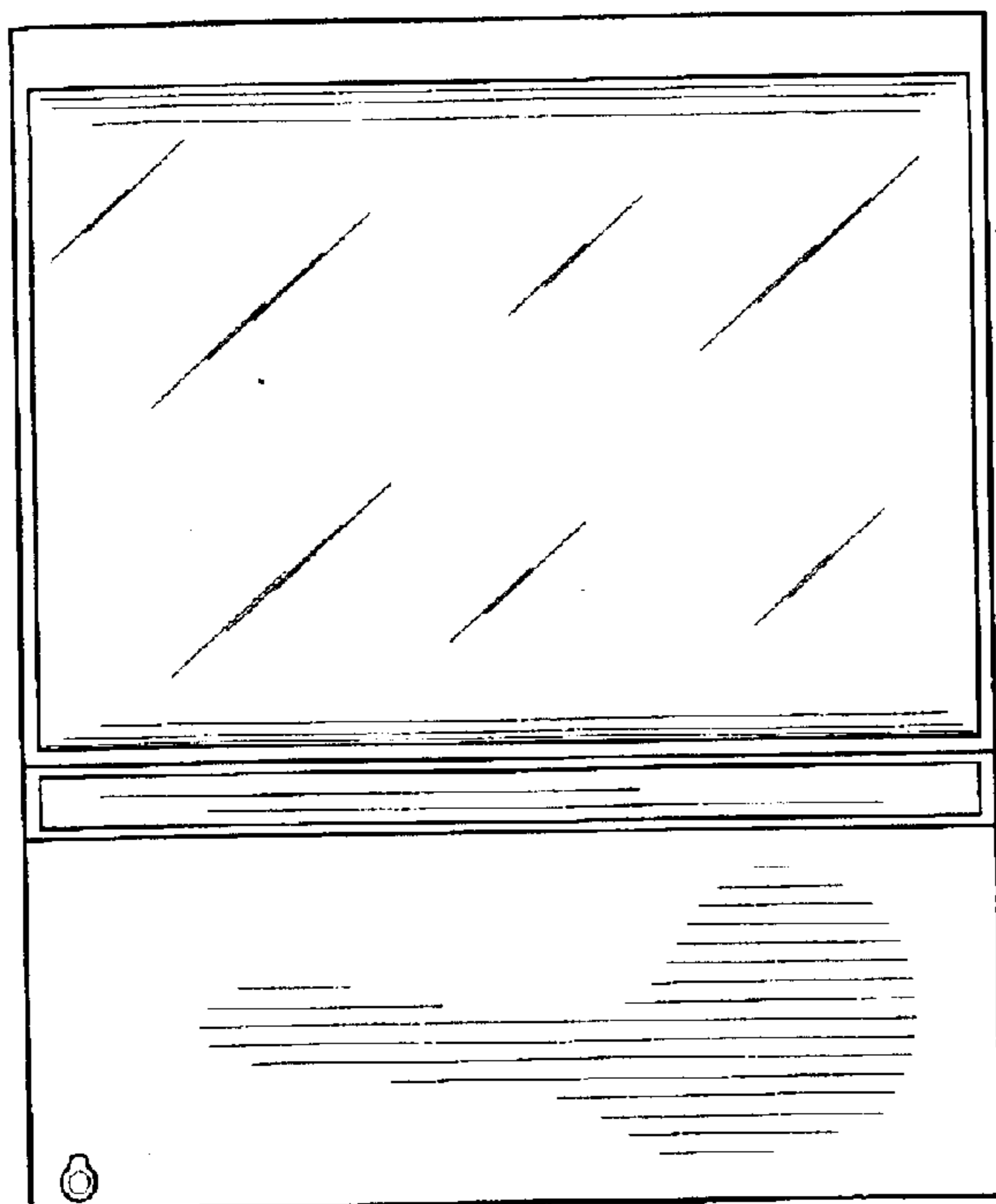

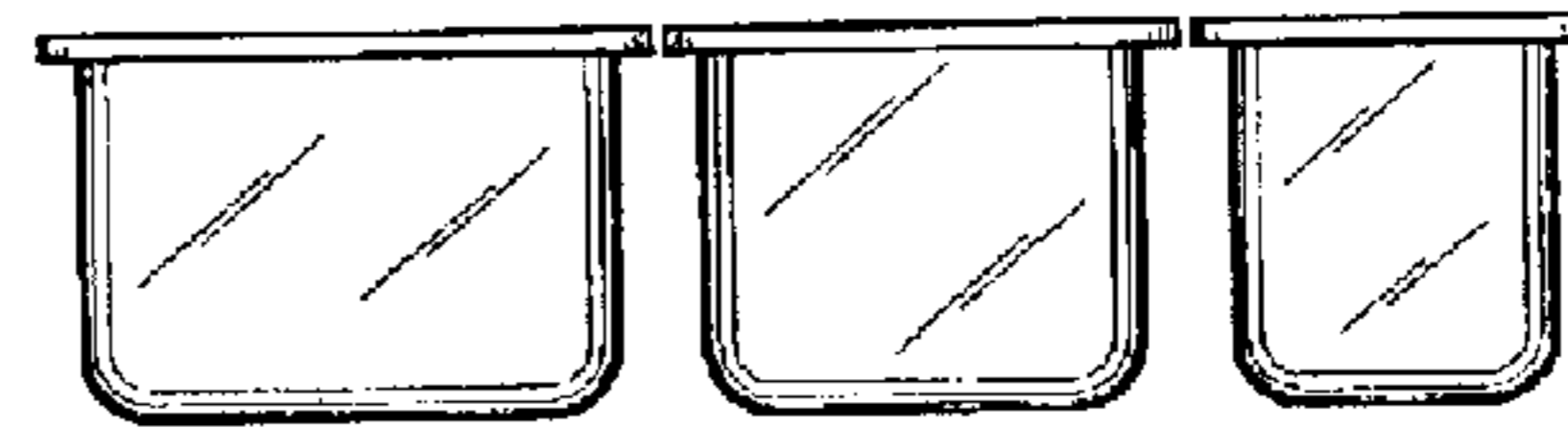
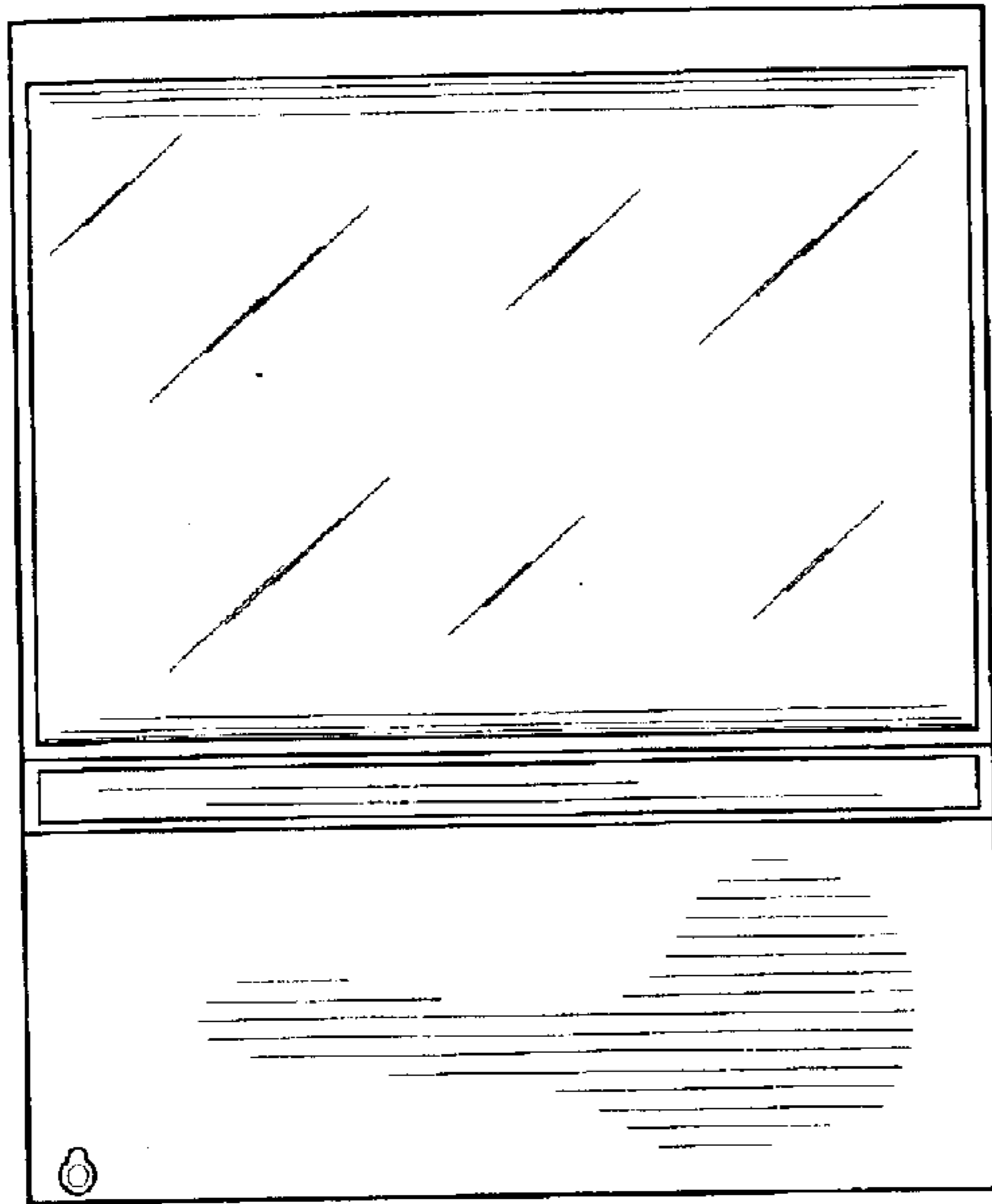

FIG. 1

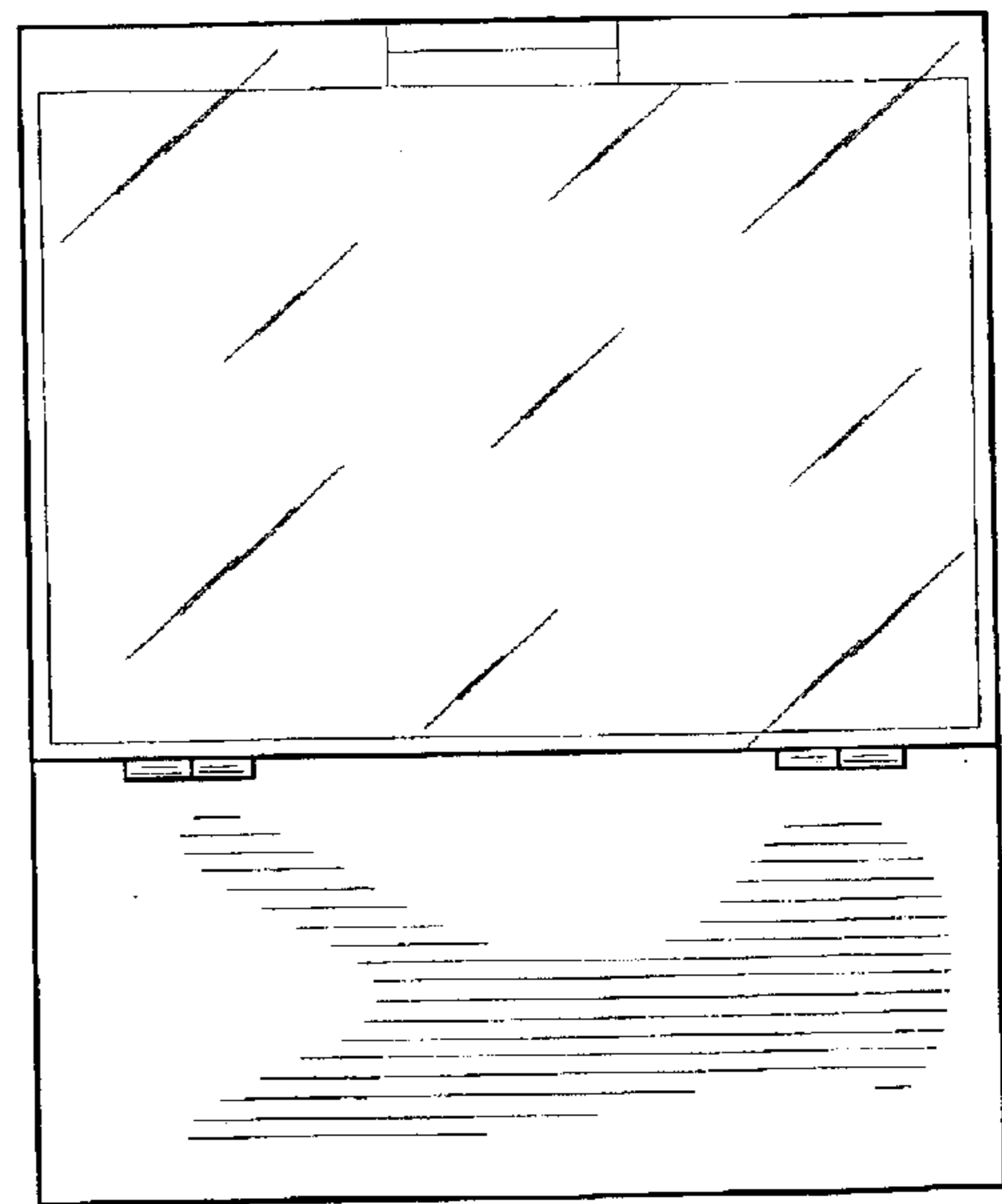
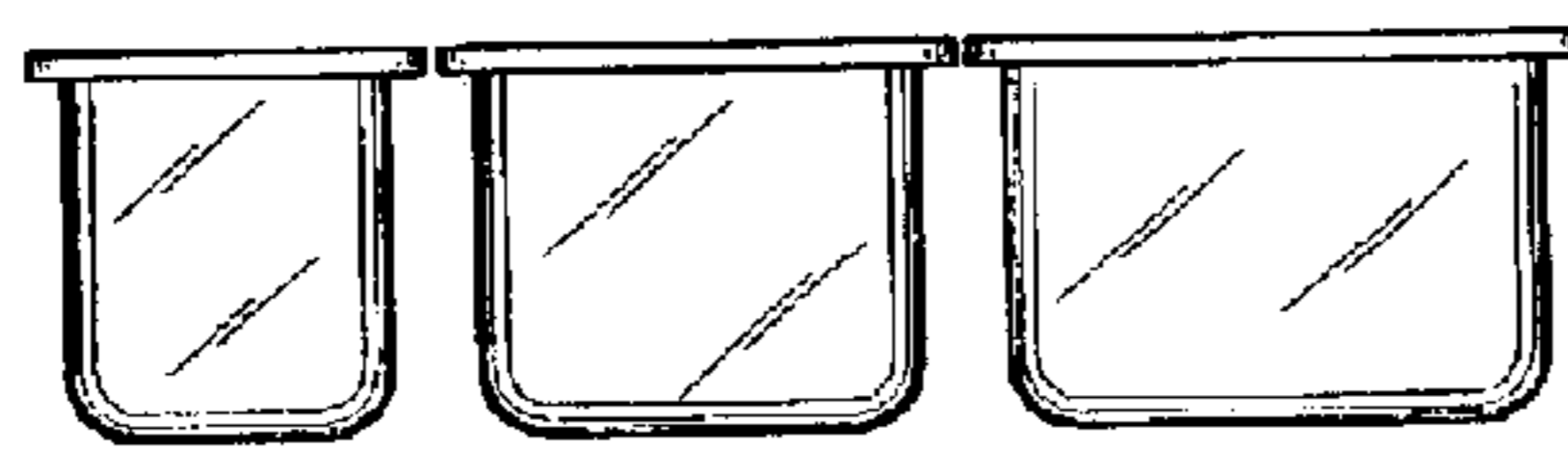

FIG. 2

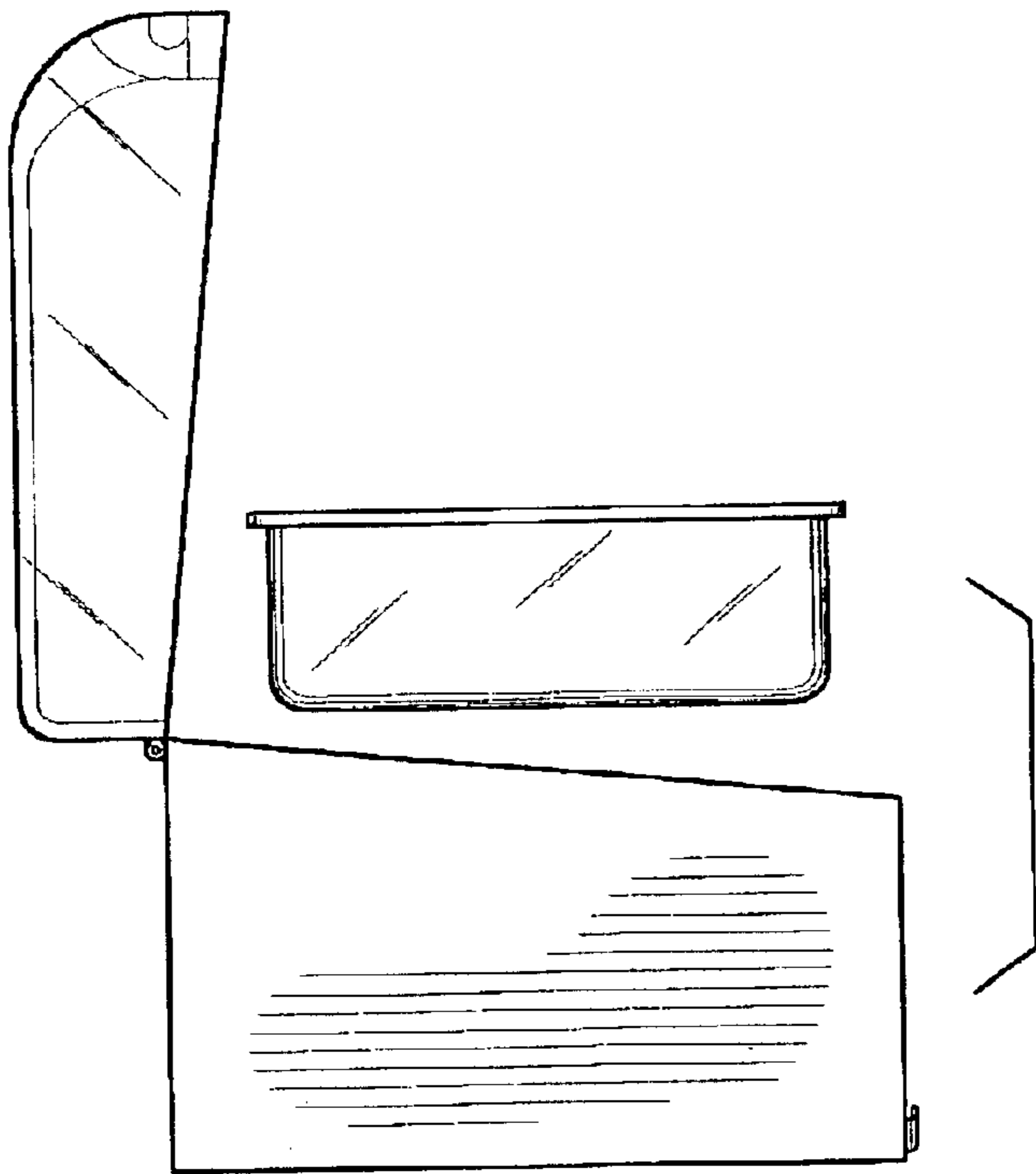

FIG. 3

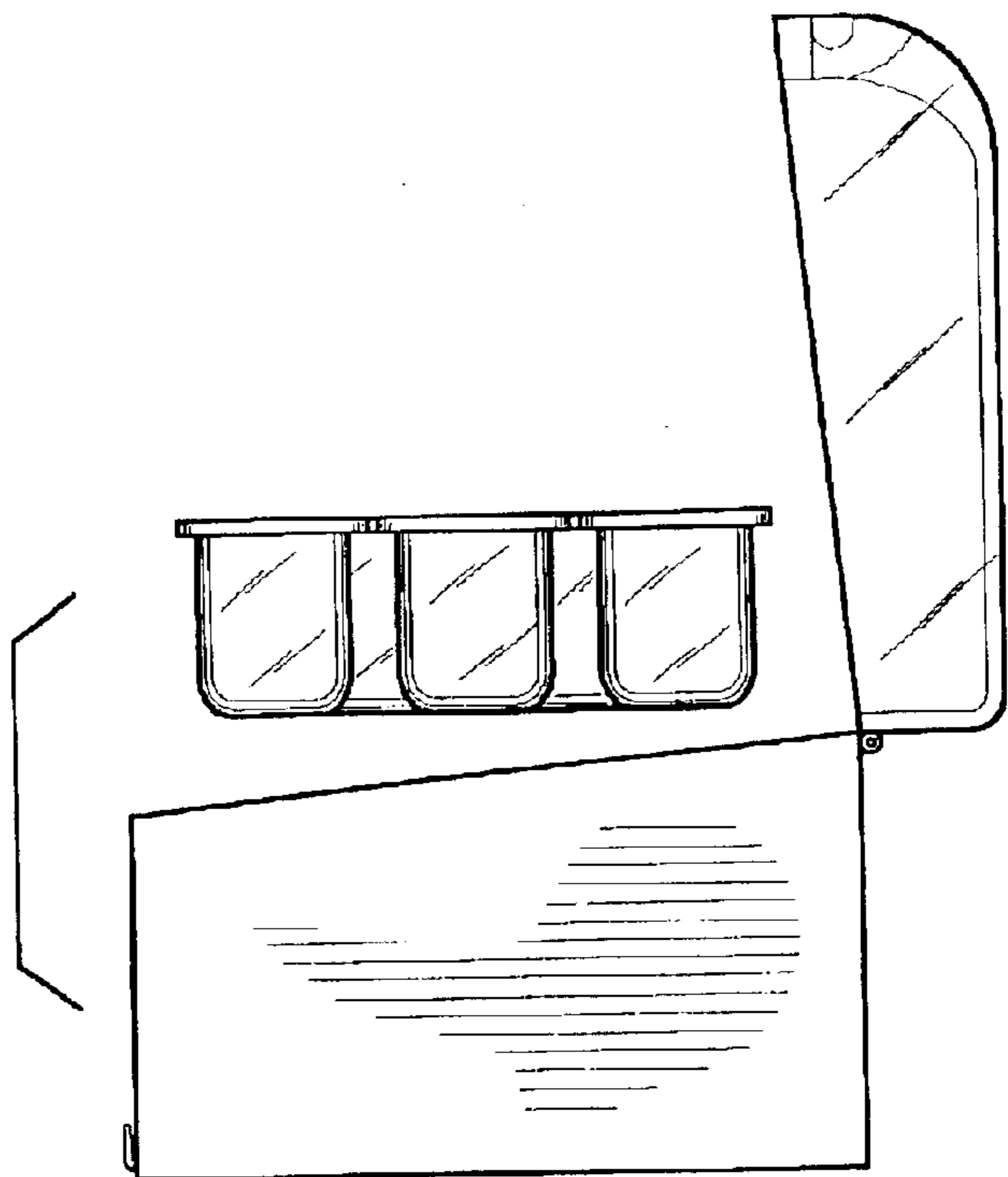

FIG. 4

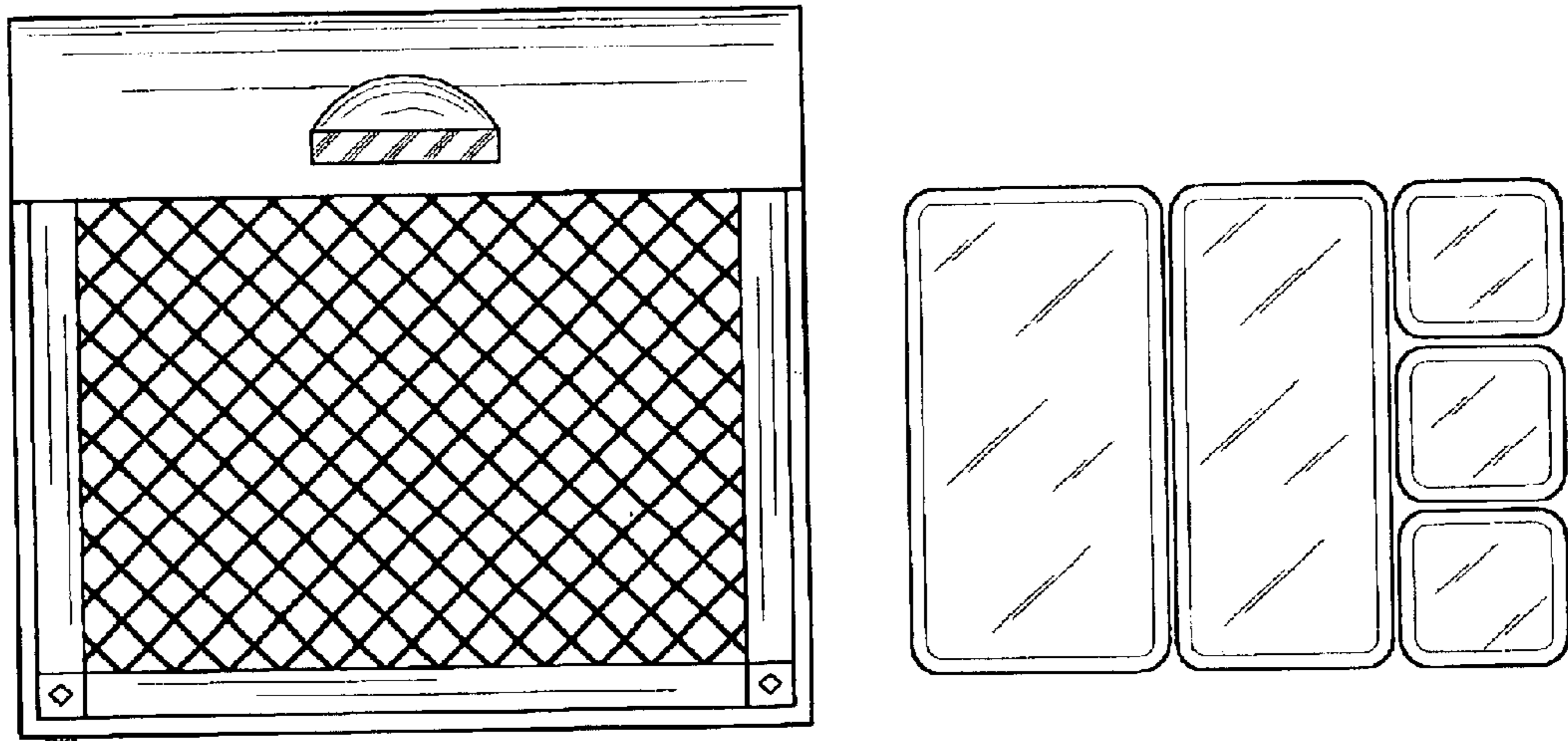

FIG. 5

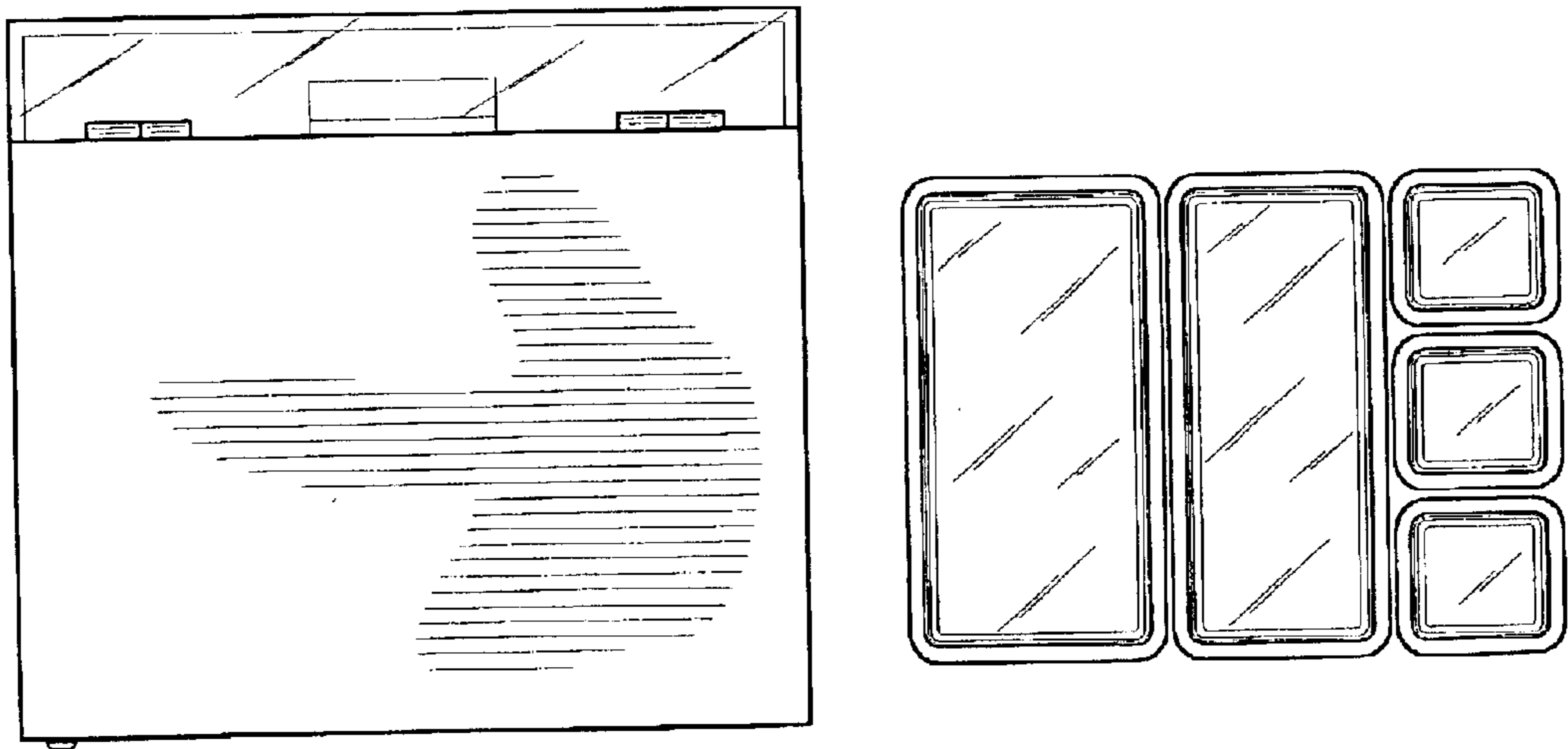

FIG. 6

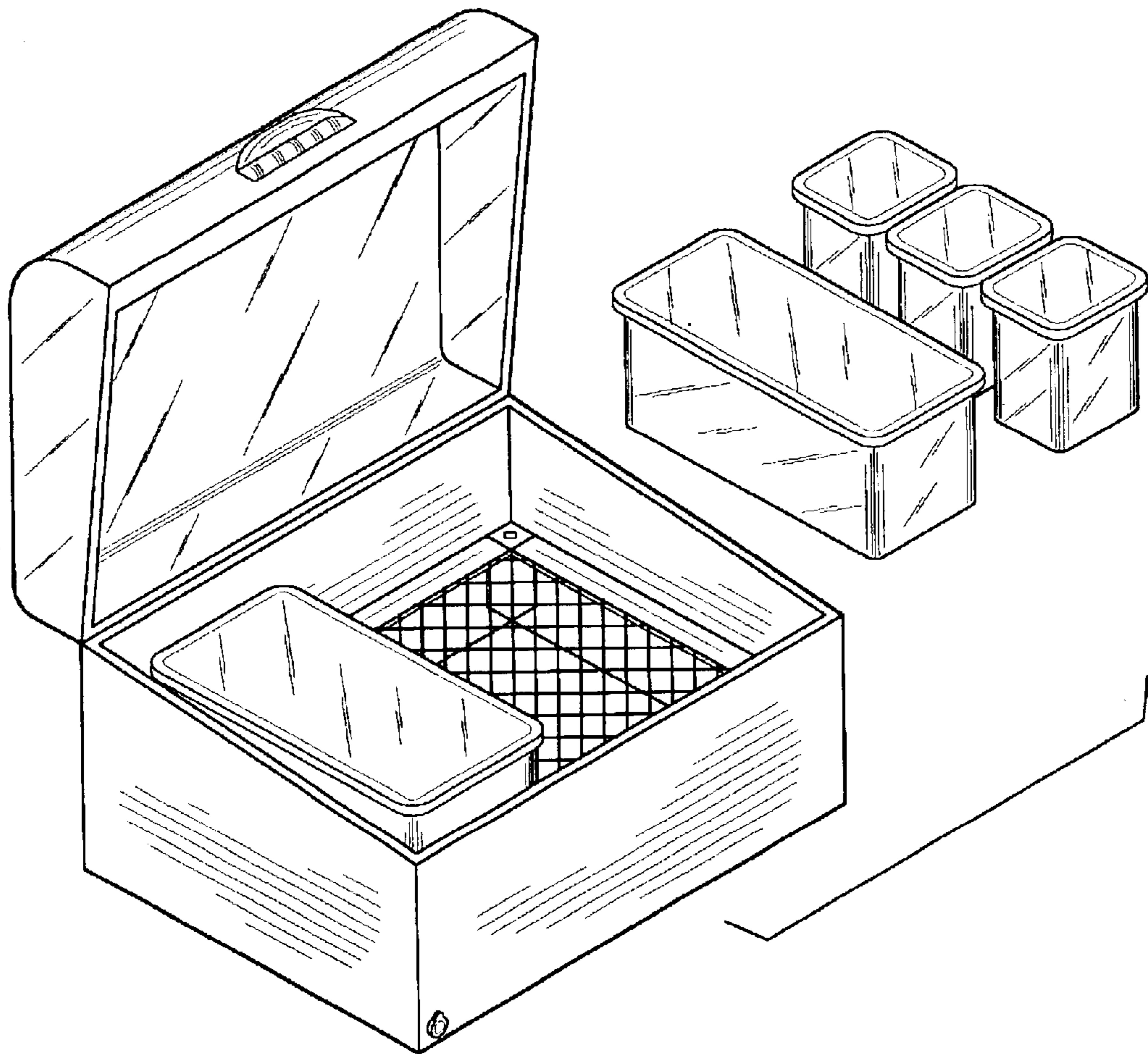

FIG. 7