



US00D488000S

(12) **United States Design Patent**  
**Chen**

(10) **Patent No.: US D488,000 S**

(45) **Date of Patent: \*\* Apr. 6, 2004**

(54) **COMPACT DISK HOLDER**

(75) **Inventor: Kun-Chang Chen, Yu Lin Hsien (TW)**

(73) **Assignee: Shian Ke Co., Ltd., Yu Lin Hsien (TW)**

(\*\*) **Term: 14 Years**

(21) **Appl. No.: 29/154,167**

(22) **Filed: Jan. 18, 2002**

(51) **LOC (7) Cl. .... 06-04**

(52) **U.S. Cl. .... D6/407**

(58) **Field of Search** ..... D3/201, 217, 218,  
D3/226, 238, 247, 254, 257, 270, 272,  
273, 276, 295, 303, 307; D6/407, 408,  
475, 626-635; D9/337, 424, 445, 454;  
206/18, 307, 307.1, 308.1, 308.2, 308.3,  
309-310, 311, 312, 313, 445, 749; 312/902,  
9.9, 9.48, 9.55, 9.64, 9.47, 9.53, 328; 379/355;  
383/18

(56) **References Cited**

**U.S. PATENT DOCUMENTS**

4,593,814	A	*	6/1986	Hagiwara et al.	.....	206/387.1
4,793,479	A		12/1988	Otsuka et al.		
D319,540	S	*	9/1991	Hehn	.....	D6/509
5,251,750	A	*	10/1993	Gelardi et al.	.....	206/308.1
D347,320	S	*	5/1994	Corday	.....	D6/634
D351,963	S		11/1994	Lim		
5,377,825	A		1/1995	Sykes et al.		
5,515,968	A		5/1996	Taniyama		
5,558,220	A		9/1996	Gartz		
D385,145	S		10/1997	VerWeyst et al.		
D386,013	S		11/1997	Tell		
5,685,427	A		11/1997	Kuitems et al.		
5,788,068	A		8/1998	Fraser et al.		
5,829,583	A		11/1998	VerWeyst et al.		

5,896,986	A	*	4/1999	Bologna et al.	.....	206/310
5,944,181	A	*	8/1999	Lau	.....	206/308.1
6,041,946	A	*	3/2000	Watson et al.	.....	211/40
D422,428	S		4/2000	Pijanowski et al.		
D433,266	S	*	11/2000	Peterson et al.	.....	D6/634
6,237,763	B1	*	5/2001	Lau	.....	206/308.1
D450,973	S	*	11/2001	Bieda	.....	D6/632
D452,105	S	*	12/2001	Chan	.....	D6/635
D452,793	S	*	1/2002	Lee	.....	D6/632
D456,166	S	*	4/2002	Seltzer	.....	D6/407
6,443,299	B2	*	9/2002	Kuremoto et al.	.....	206/308.1
6,478,150	B1	*	11/2002	Solling	.....	206/308.1
D466,718	S	*	12/2002	Abeyta, Jr. et al.	.....	D6/407
6,547,068	B2	*	4/2003	Chu	.....	206/310
6,547,069	B2	*	4/2003	Chang	.....	206/310
6,554,132	B2	*	4/2003	Lau	.....	206/303

\* cited by examiner

*Primary Examiner*—Celia Murphy

(74) *Attorney, Agent, or Firm*—Alan D. Kamrath; Rider Bennett, LLP.

(57) **CLAIM**

The ornamental design for a compact disc holder, as shown and described.

**DESCRIPTION**

FIG. 1 is a front elevational view of a compact disc holder showing my design;  
FIG. 2 is a rear elevational view thereof;  
FIG. 3 is a left side elevational view thereof;  
FIG. 4 is a right side elevational view thereof;  
FIG. 5 is a top plan view thereof;  
FIG. 6 is a bottom plan view thereof; and,  
FIG. 7 is a perspective view thereof.  
The broken lines showing a CD case throughout the views, represent the environment in which the design resides; and they from no part of the claim.

**1 Claim, 5 Drawing Sheets**

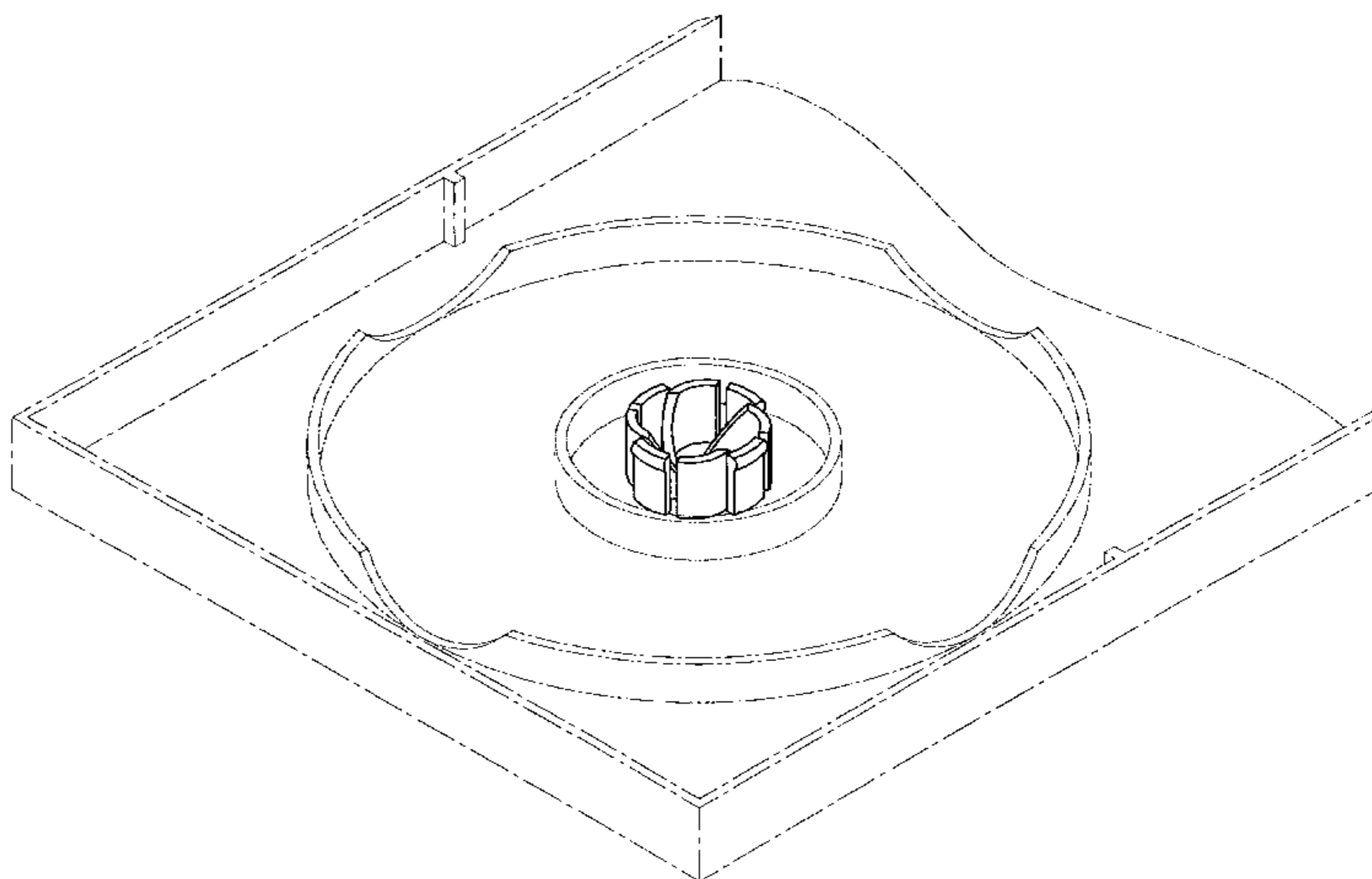
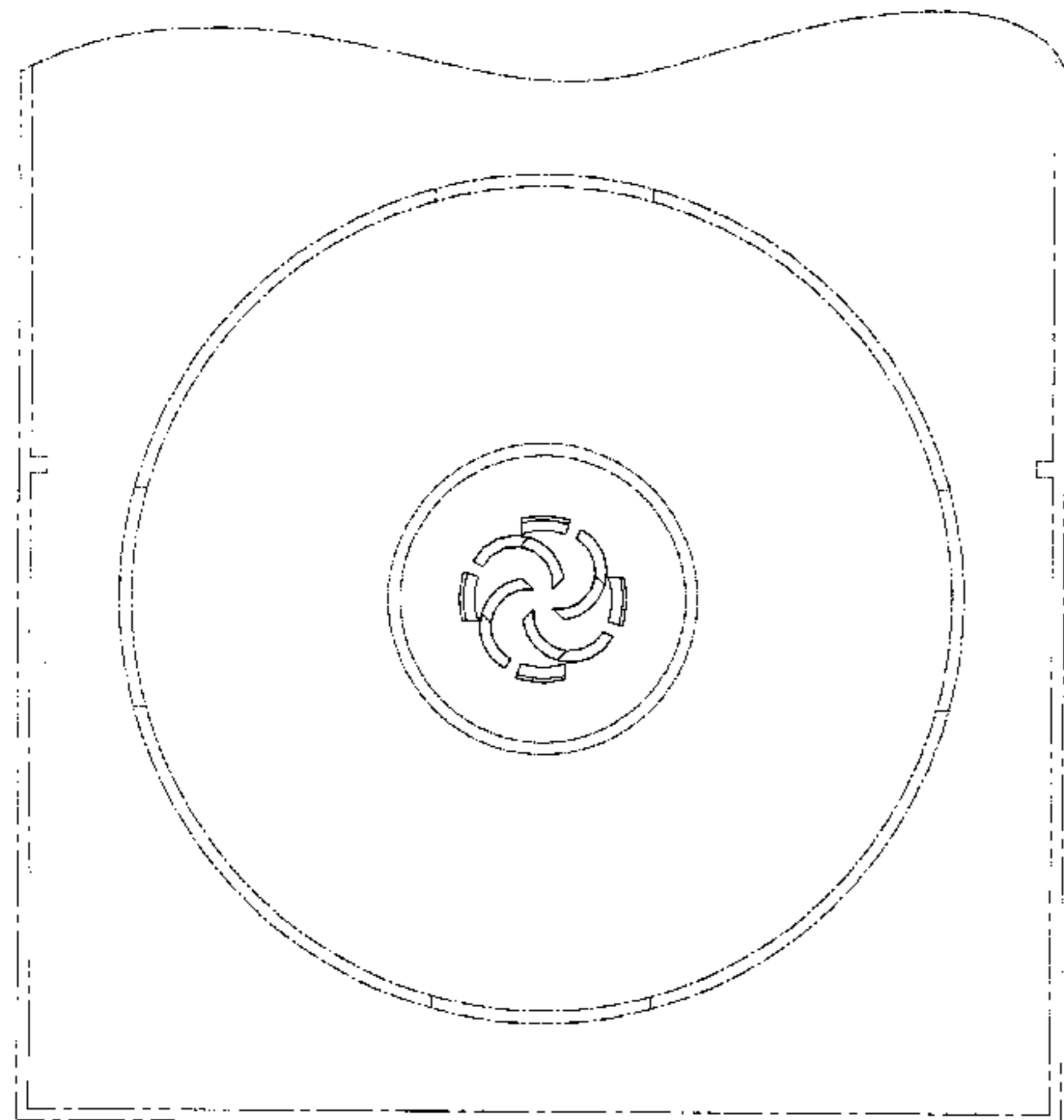

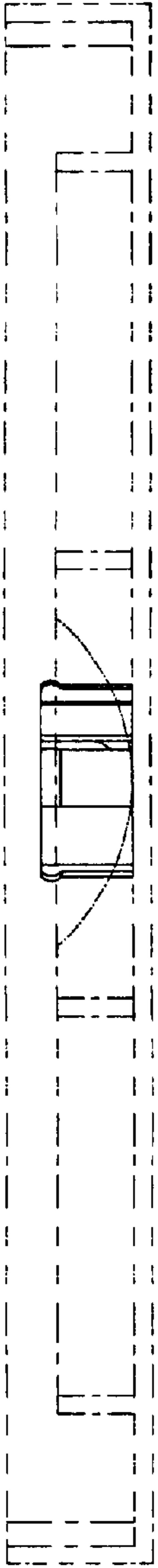

Fig. 1

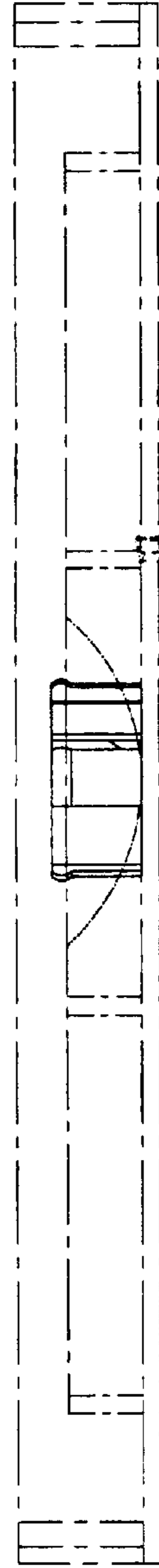

Fig. 2

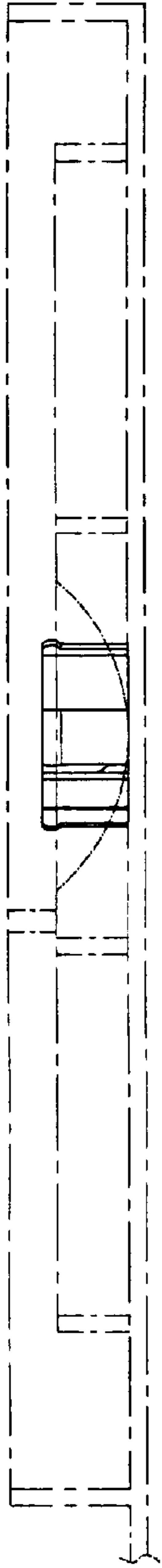

Fig.3

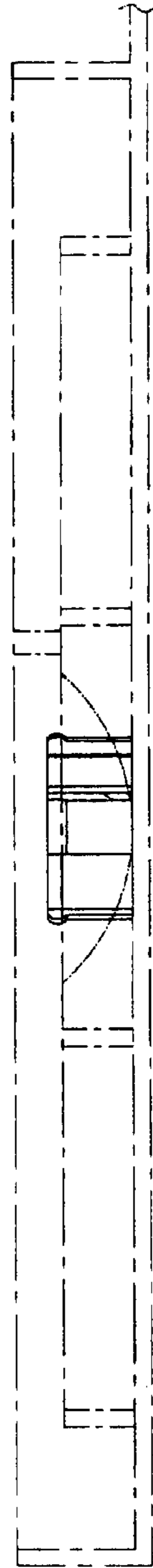

Fig.4

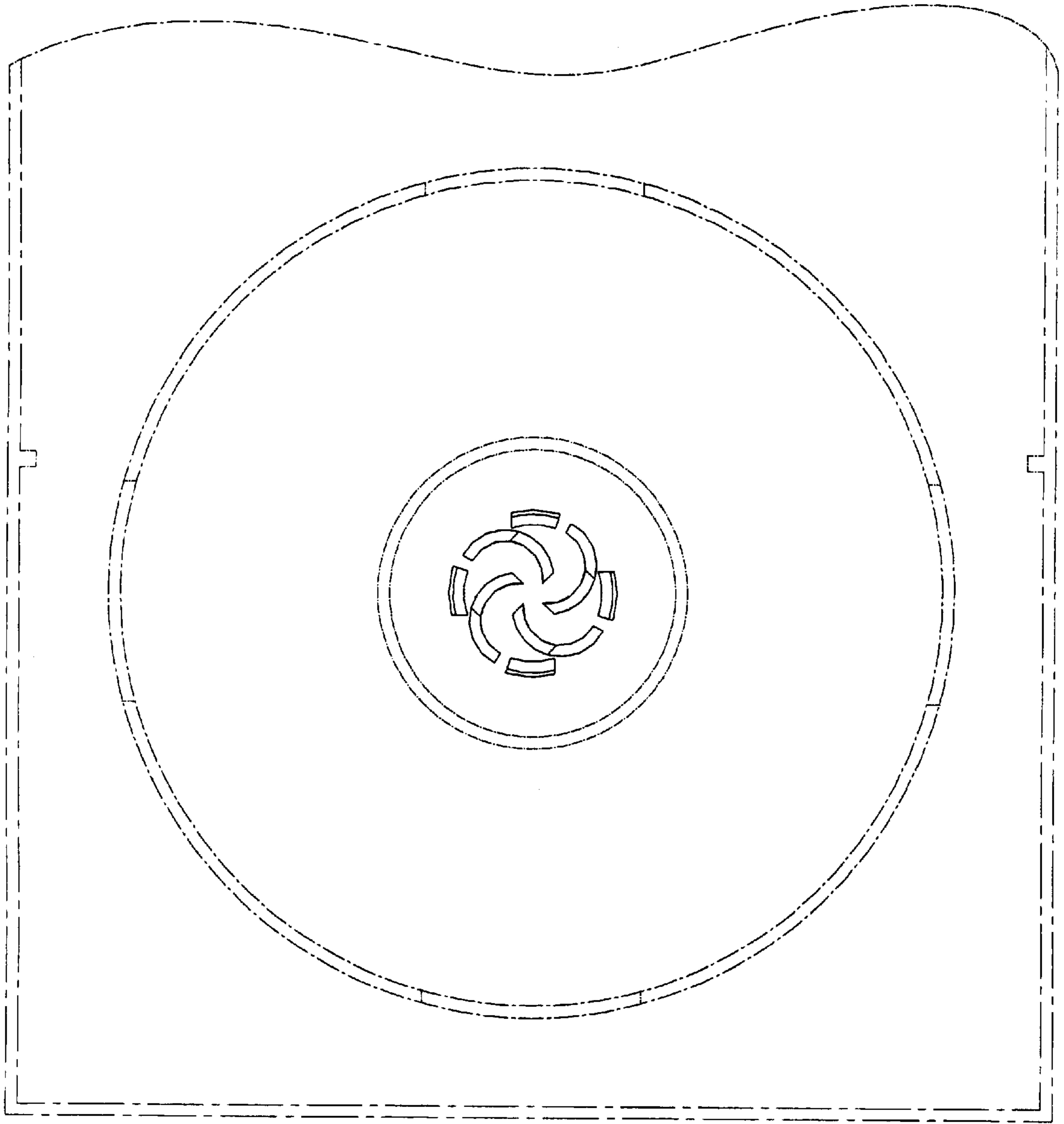

Fig.5

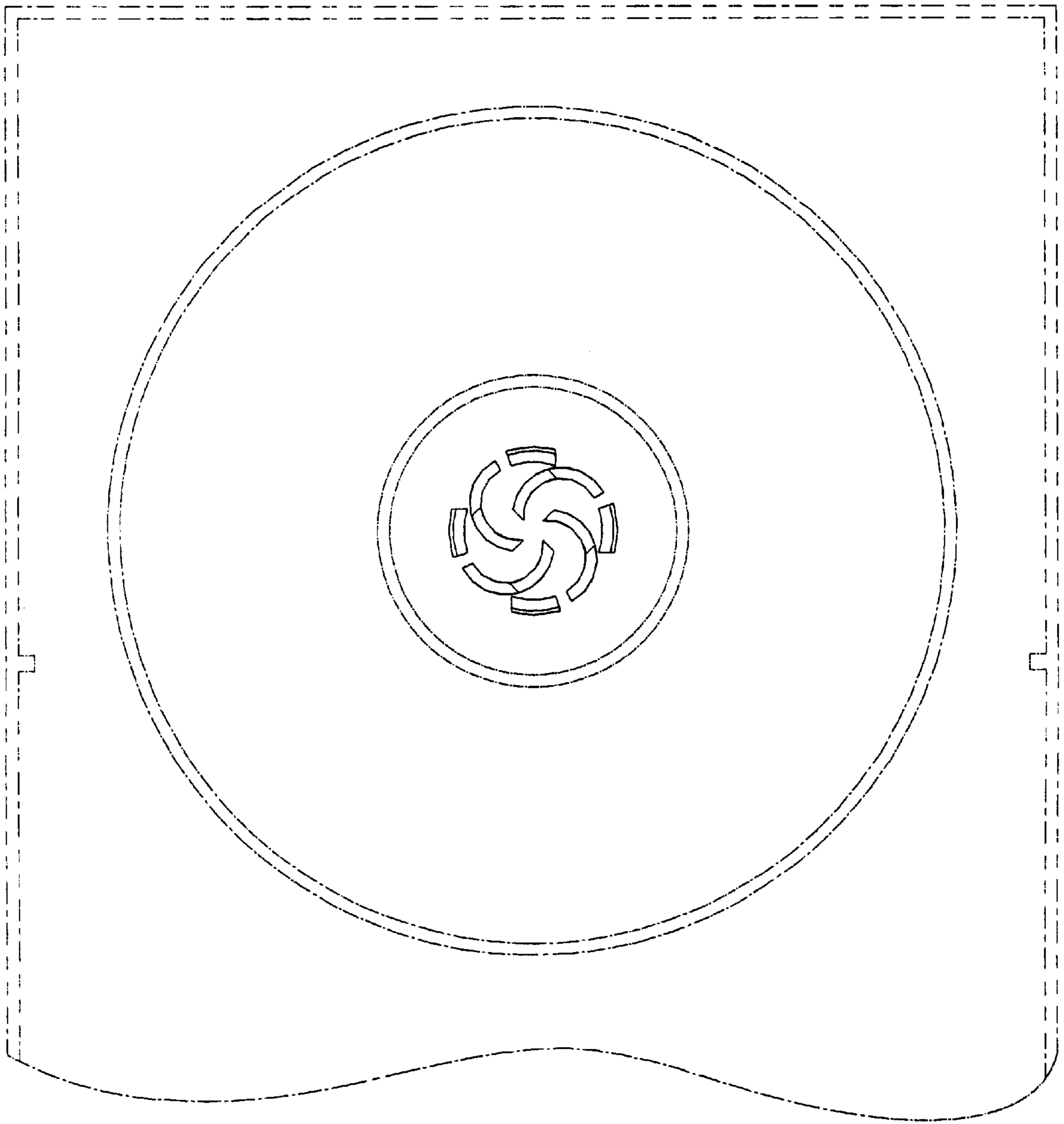

Fig.6

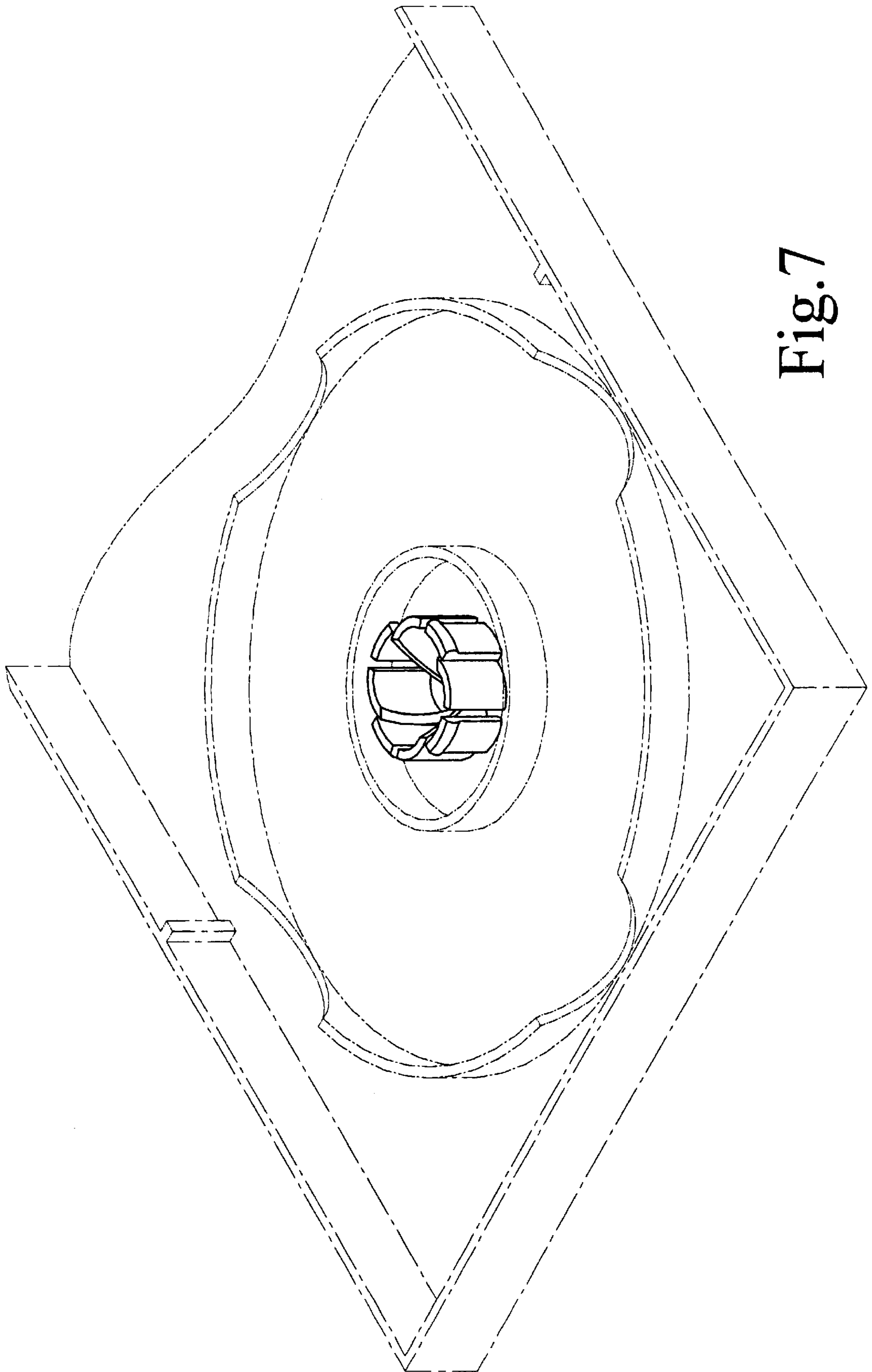

Fig. 7