



US00D487986S

(12) **United States Design Patent**
Muller

(10) **Patent No.:** **US D487,986 S**

(45) **Date of Patent:** **** Apr. 6, 2004**

(54) **CHAIR**

(75) **Inventor:** **Carl Muller**, Huntington Beach, CA
(US)

(73) **Assignee:** **Elite Manufacturing Corp.**, Santa Fe
Springs, CA (US)

(**) **Term:** **14 Years**

(21) **Appl. No.:** **29/182,385**

(22) **Filed:** **May 22, 2003**

(51) **LOC (7) Cl.** **06-01**

(52) **U.S. Cl.** **D6/365**

(58) **Field of Search** D6/334, 335, 336,
D6/364, 365, 366, 367, 374, 375, 379,
498, 500-502; 297/411.2, 411.44; 248/188.7

(56) **References Cited**

U.S. PATENT DOCUMENTS

D113,191 S * 1/1939 Salomon D6/366
4,363,460 A * 12/1982 Carroll 248/188.7
D299,986 S * 2/1989 Doughty D6/365

D331,154 S * 11/1992 Sheridan D6/366
5,739,449 A * 4/1998 Torres, Jr. 248/188.7
D394,962 S * 6/1998 Diramarian D6/366
D444,307 S * 7/2001 Minami D6/360
D444,636 S * 7/2001 Ooyama D6/360

* cited by examiner

Primary Examiner—Doris V. Coles

Assistant Examiner—Mimosa De

(74) *Attorney, Agent, or Firm*—George W. Finch

(57) **CLAIM**

The ornamental design for a chair, as shown.

DESCRIPTION

FIG. 1 is a perspective view showing the front side, right side, and top of the ornamental design;
FIG. 2 is a front elevational view thereof;
FIG. 3 is a back view thereof;
FIG. 4 is a right side elevational view thereof;
FIG. 5 is a left side elevational view thereof;
FIG. 6 is a top plan view thereof; and,
FIG. 7 is a bottom view thereof.

1 Claim, 2 Drawing Sheets

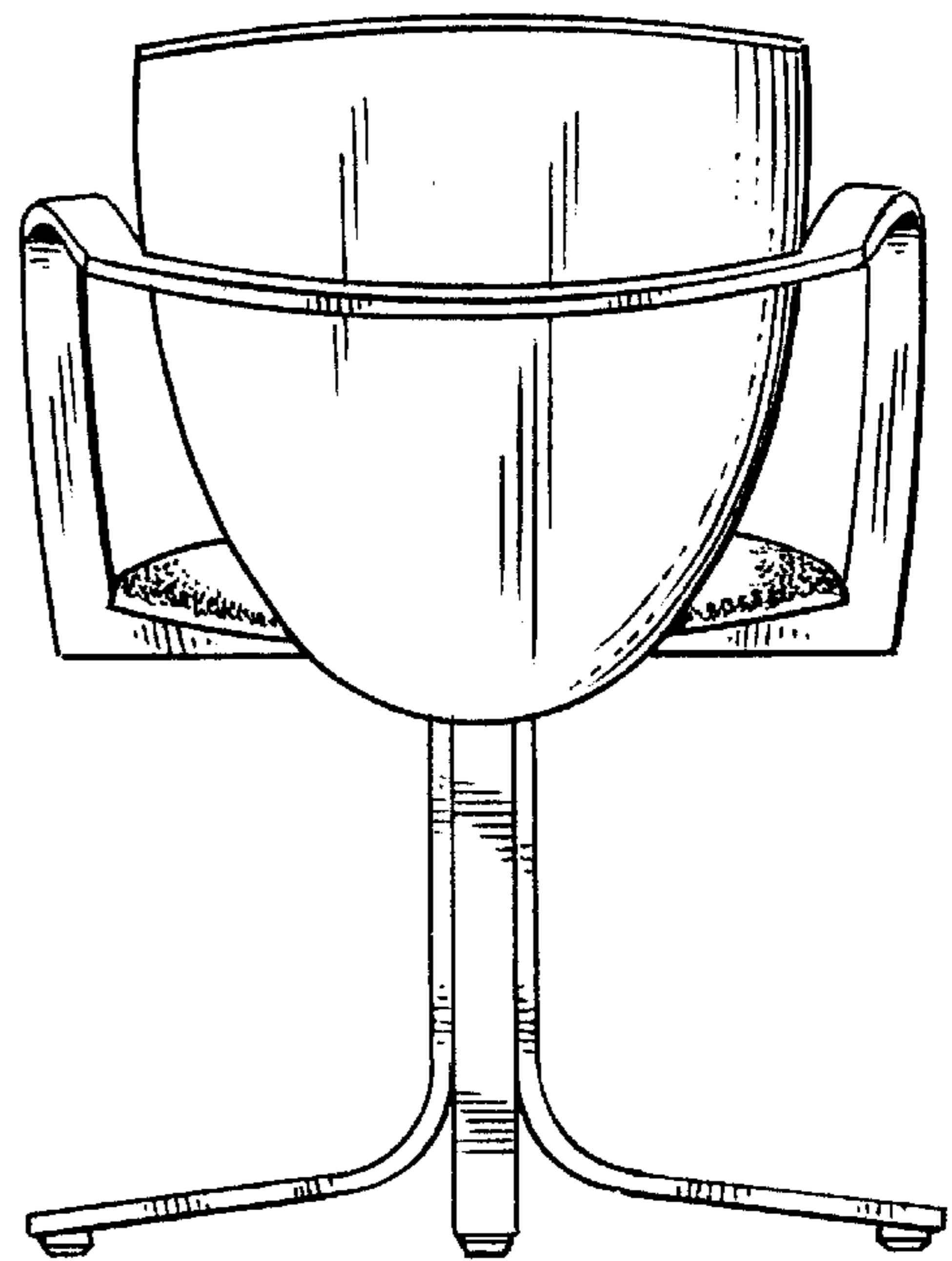

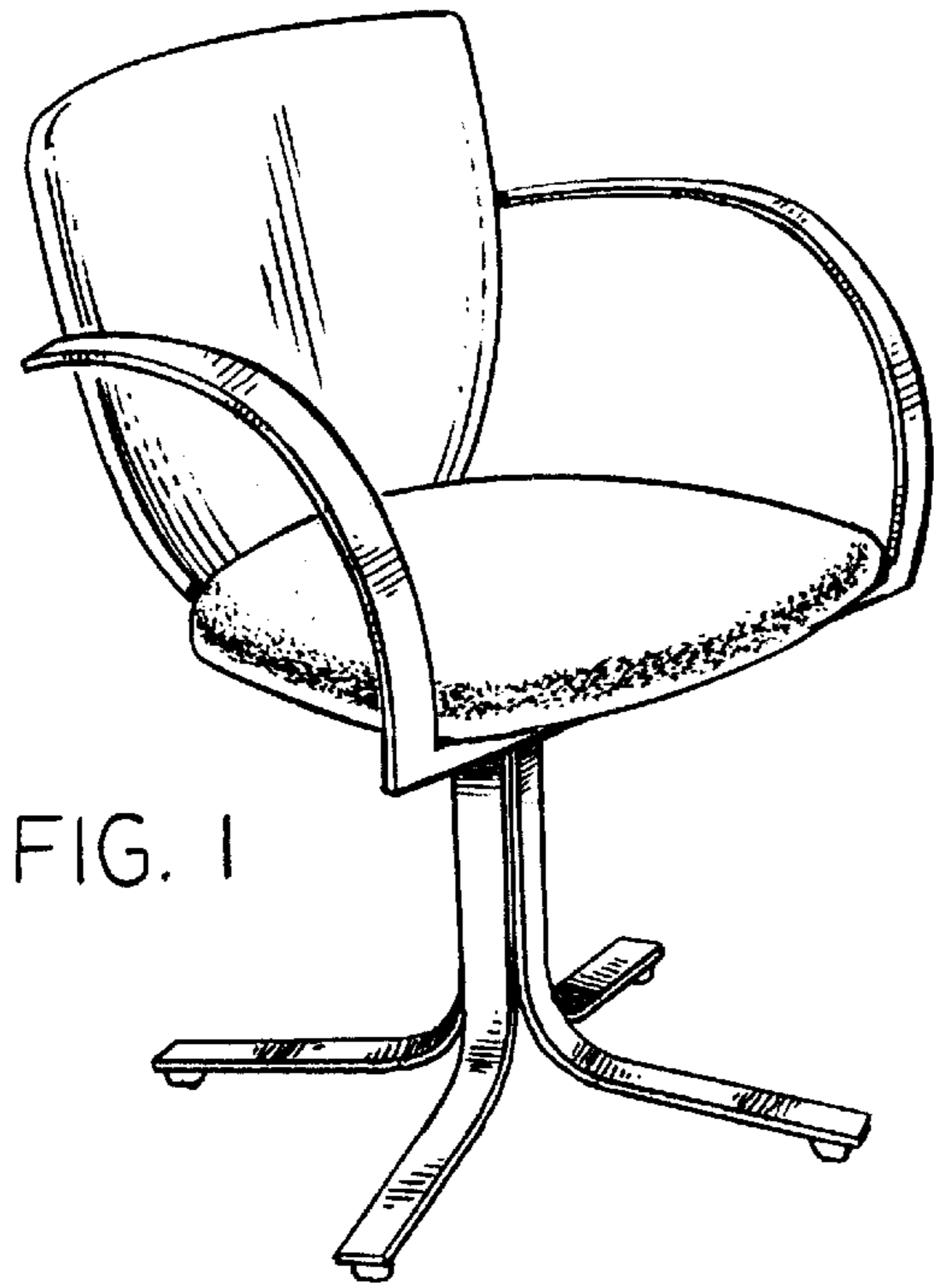

FIG. 1

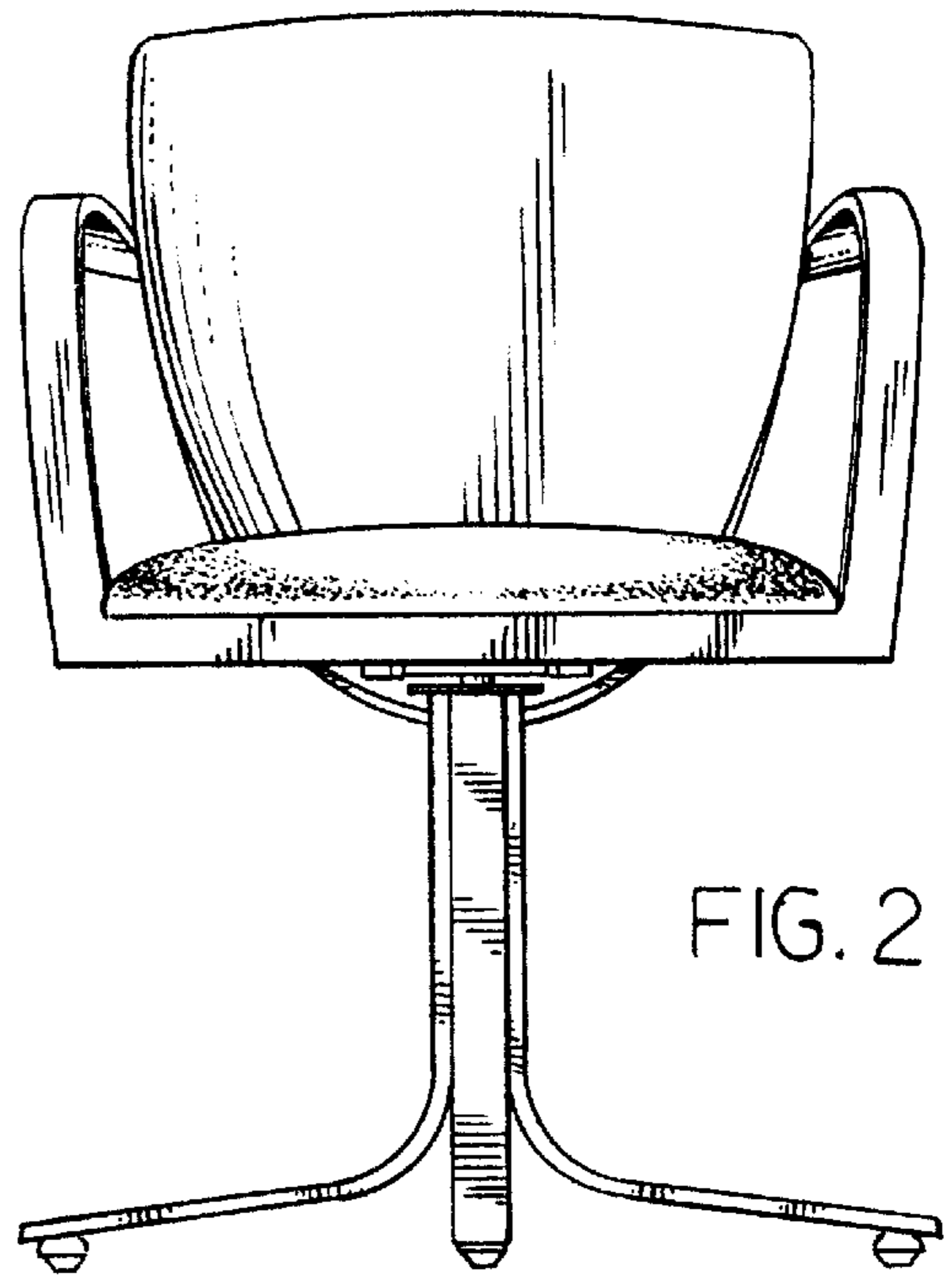

FIG. 2

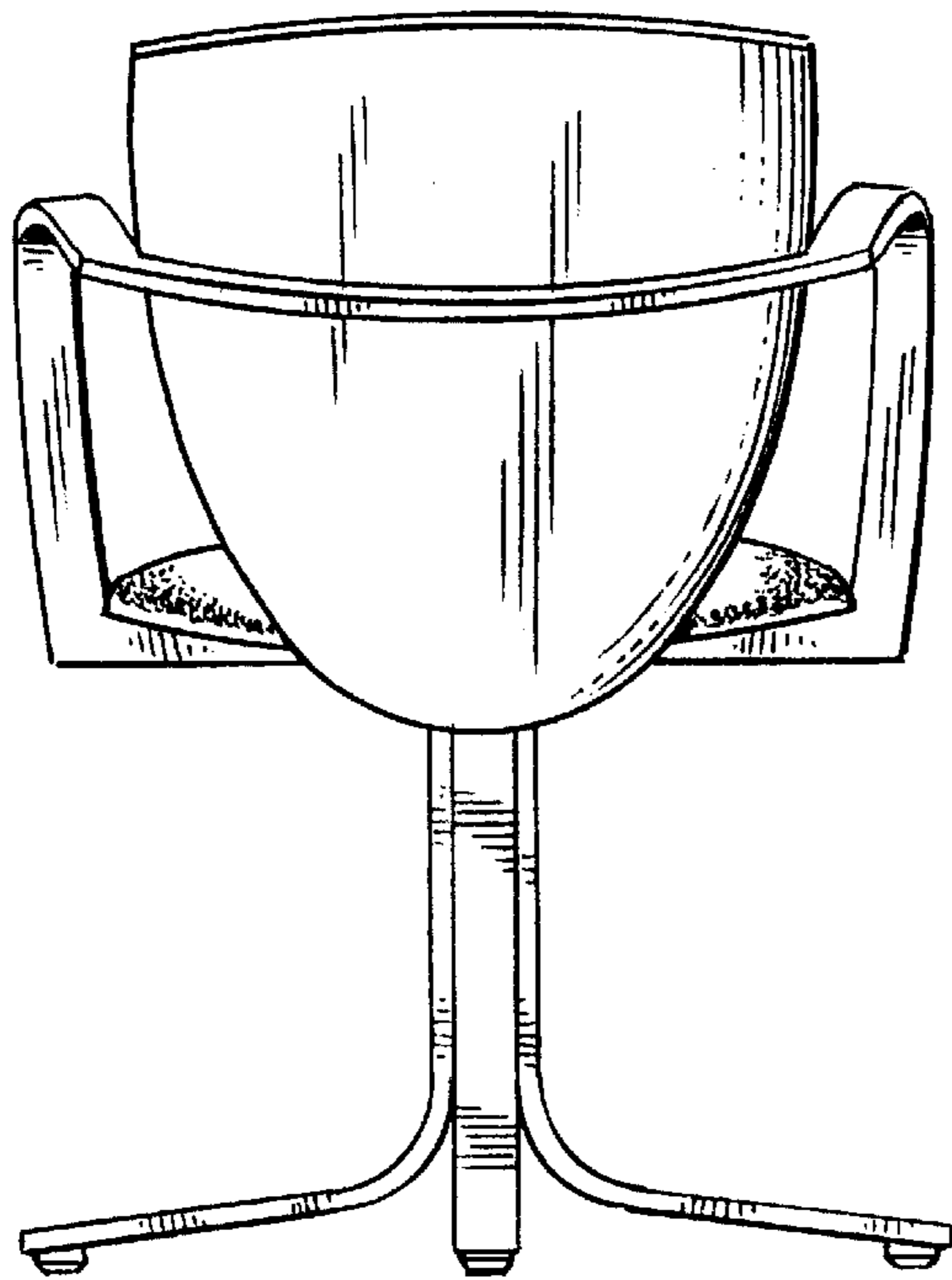

FIG. 3

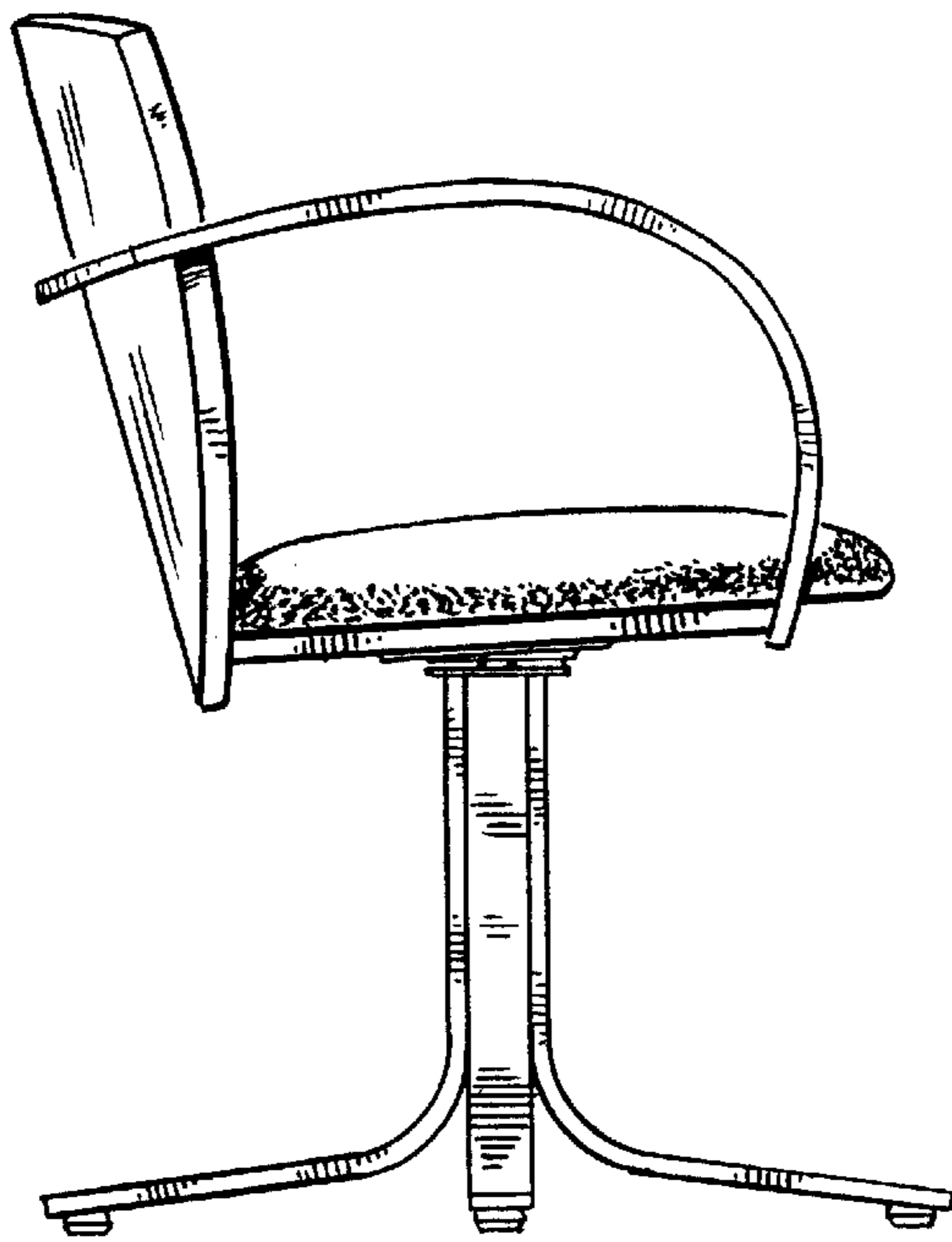

FIG. 4

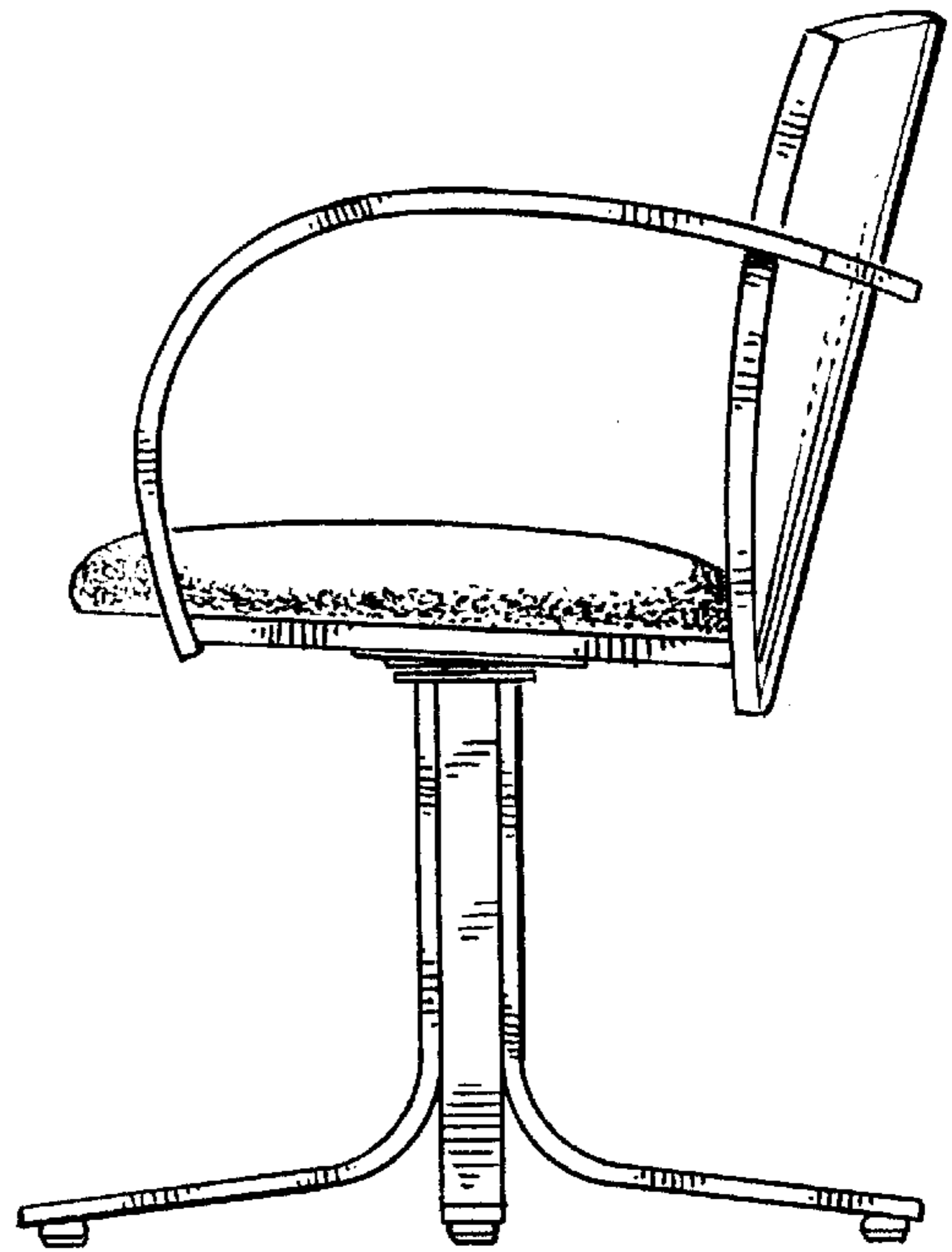

FIG. 5

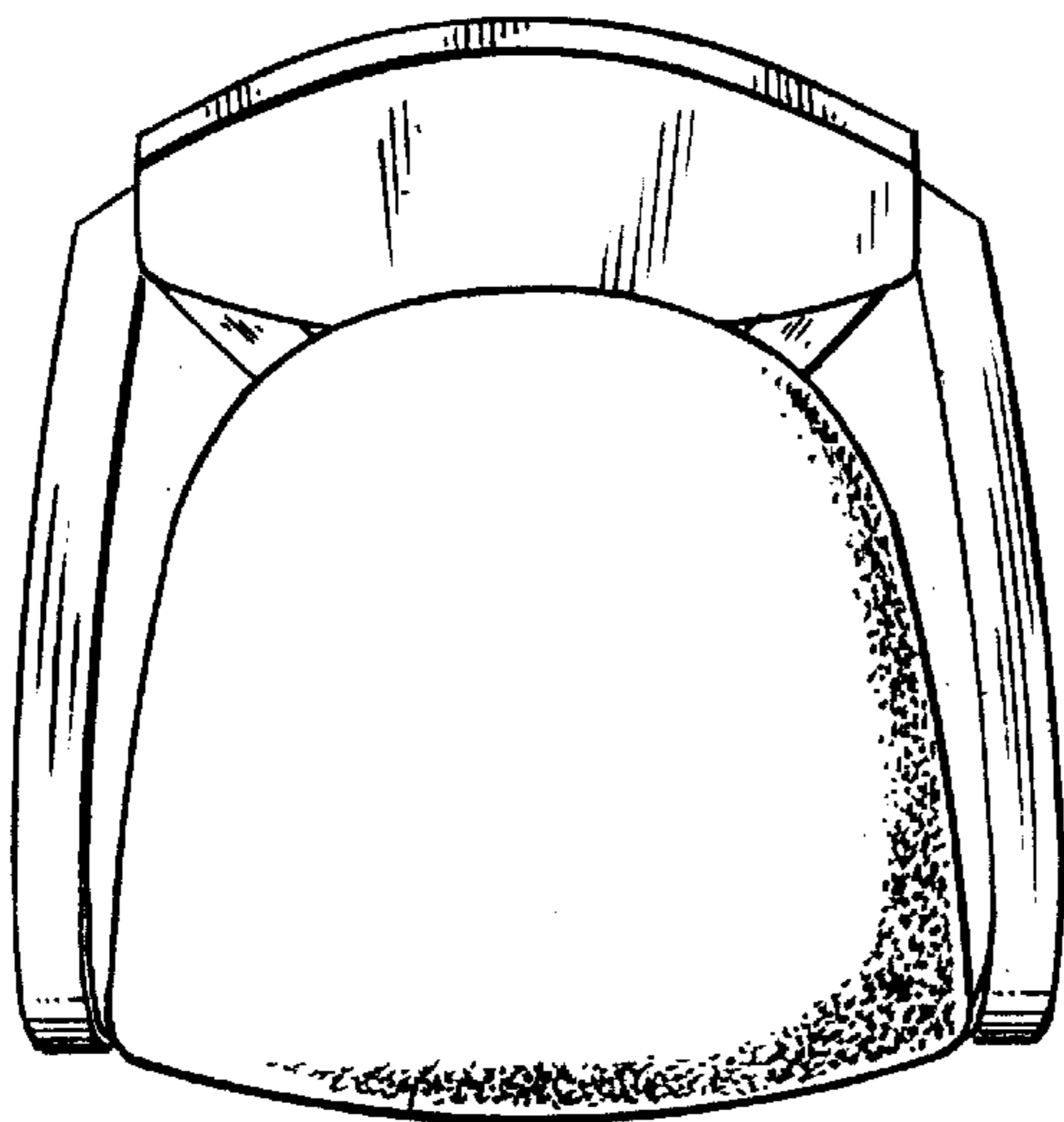

FIG. 6

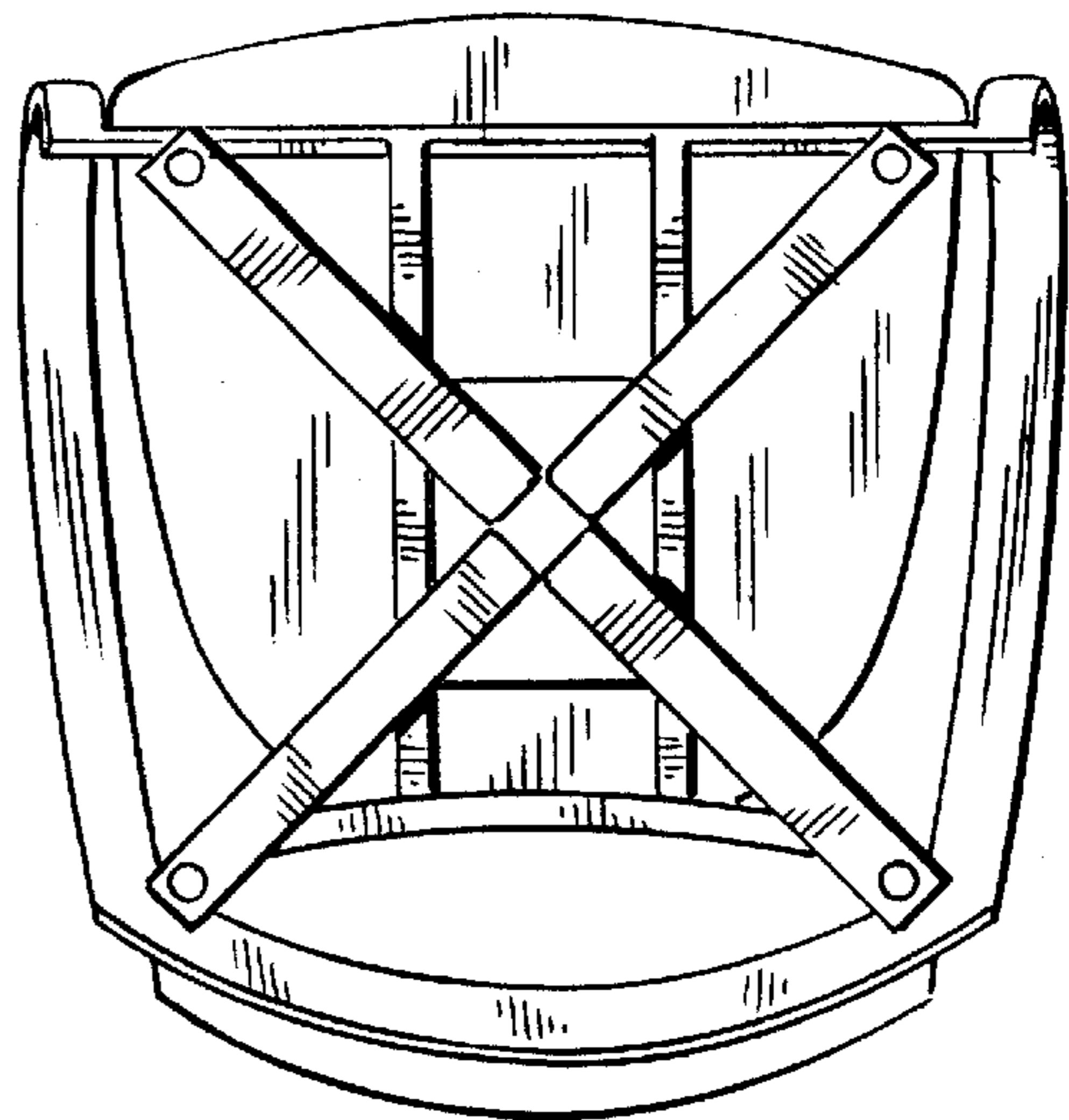

FIG. 7