



US00D487915S

(12) **United States Design Patent**
Egee

(10) **Patent No.:** **US D487,915 S**

(45) **Date of Patent:** **** Mar. 30, 2004**

(54) **SHOWER HEAD**

D467,300 S * 12/2002 Singtoroj D23/213
D468,394 S * 1/2003 Cummings D23/213

(75) Inventor: **Paul Egee**, Southbury, CT (US)

* cited by examiner

(73) Assignee: **American Standard International Inc.**, New York, NY (US)

Primary Examiner—Robin V. Taylor

(**) Term: **14 Years**

(57) **CLAIM**

(21) Appl. No.: **29/179,135**

The ornamental design for a shower head, as shown and described.

(22) Filed: **Apr. 4, 2003**

DESCRIPTION

(51) **LOC (7) Cl.** **23-01**

FIG. 1 is a perspective view of a shower head showing my new design;

(52) **U.S. Cl.** **D23/229**

FIG. 2 is a top plan view thereof;

(58) **Field of Search** D23/213, 229,
D23/230; 239/548, 282, 390

FIG. 3 is a left side elevational view thereof, the right side view being a mirror image of the left side;

FIG. 4 is a front elevational view thereof;

FIG. 5 is a rear elevational view thereof; and,

FIG. 6 is a bottom plan view.

The broken line showing of is for illustrative purposes only and forms no part of the claimed design.

(56) **References Cited**

U.S. PATENT DOCUMENTS

1,597,477 A * 8/1926 Panhorst 239/548
2,965,313 A * 12/1960 Jay 239/581.1
D465,553 S * 11/2002 Singtoroj D23/229

1 Claim, 5 Drawing Sheets

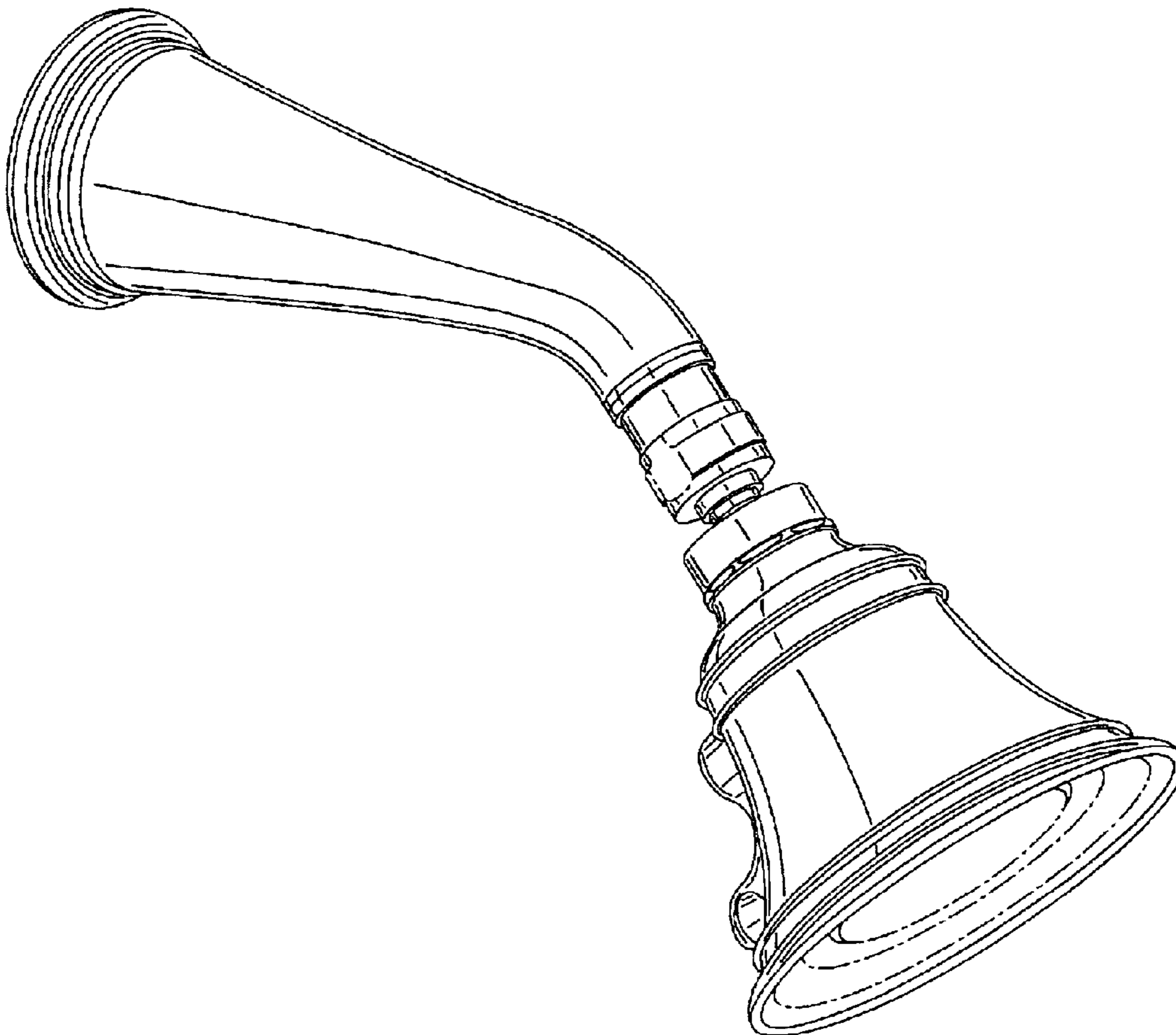

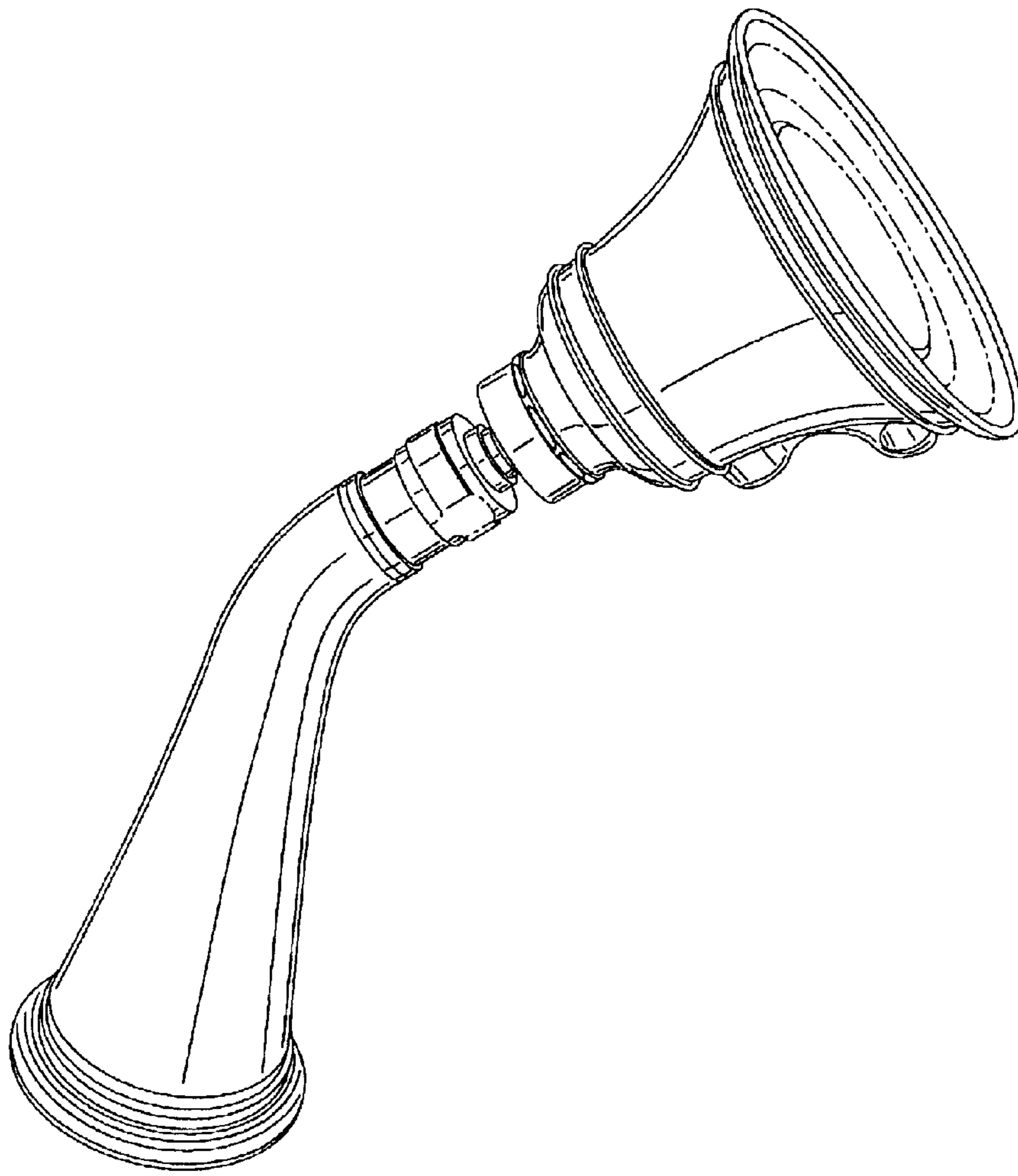

FIG. 1

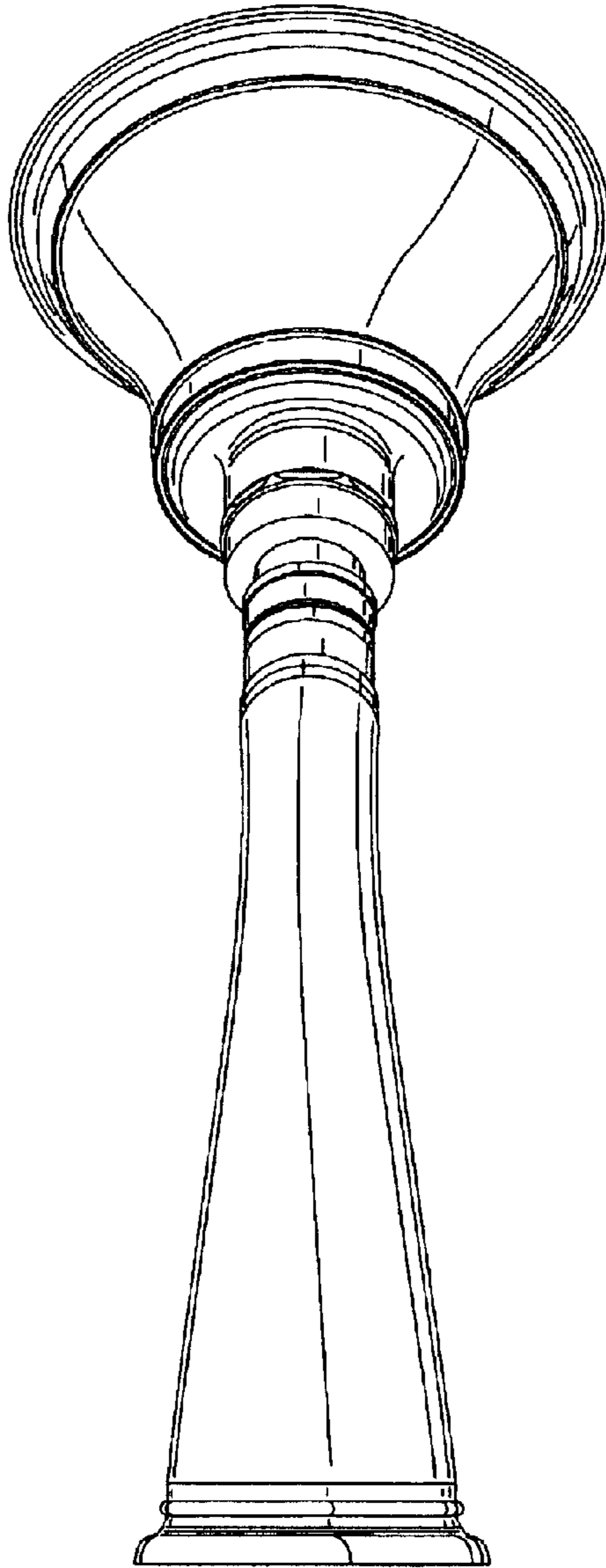

FIG. 2

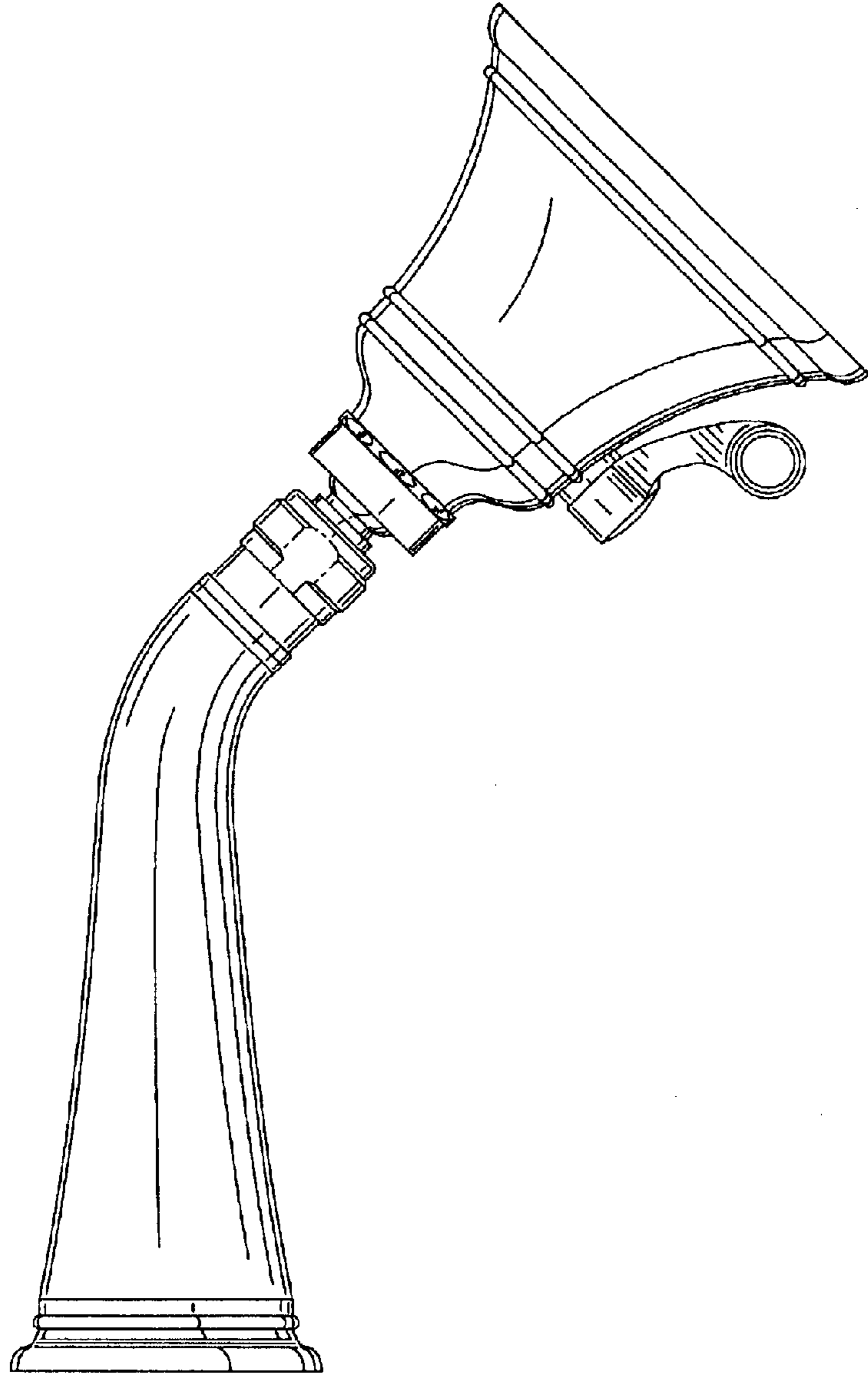

FIG. 3

FIG. 5

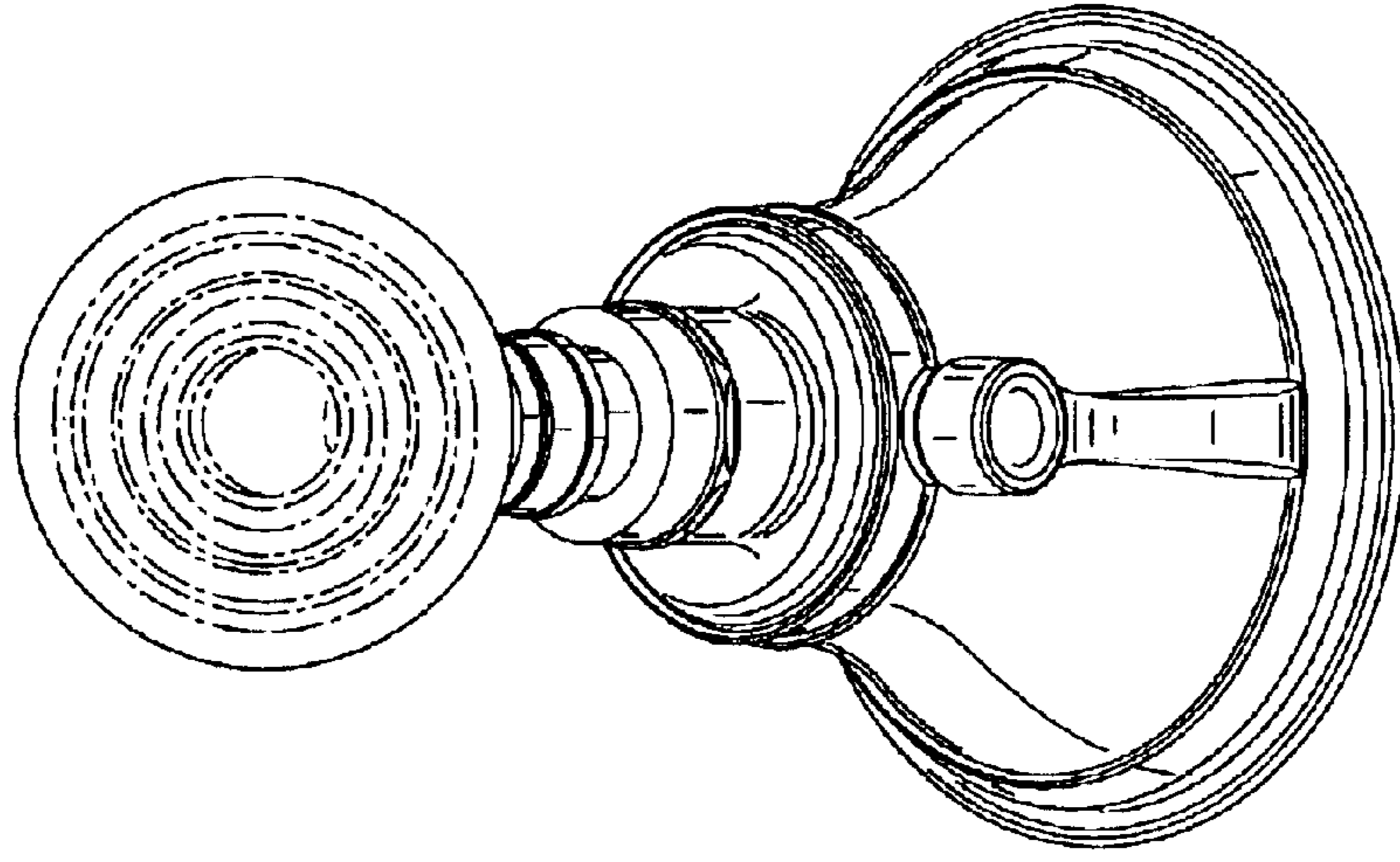
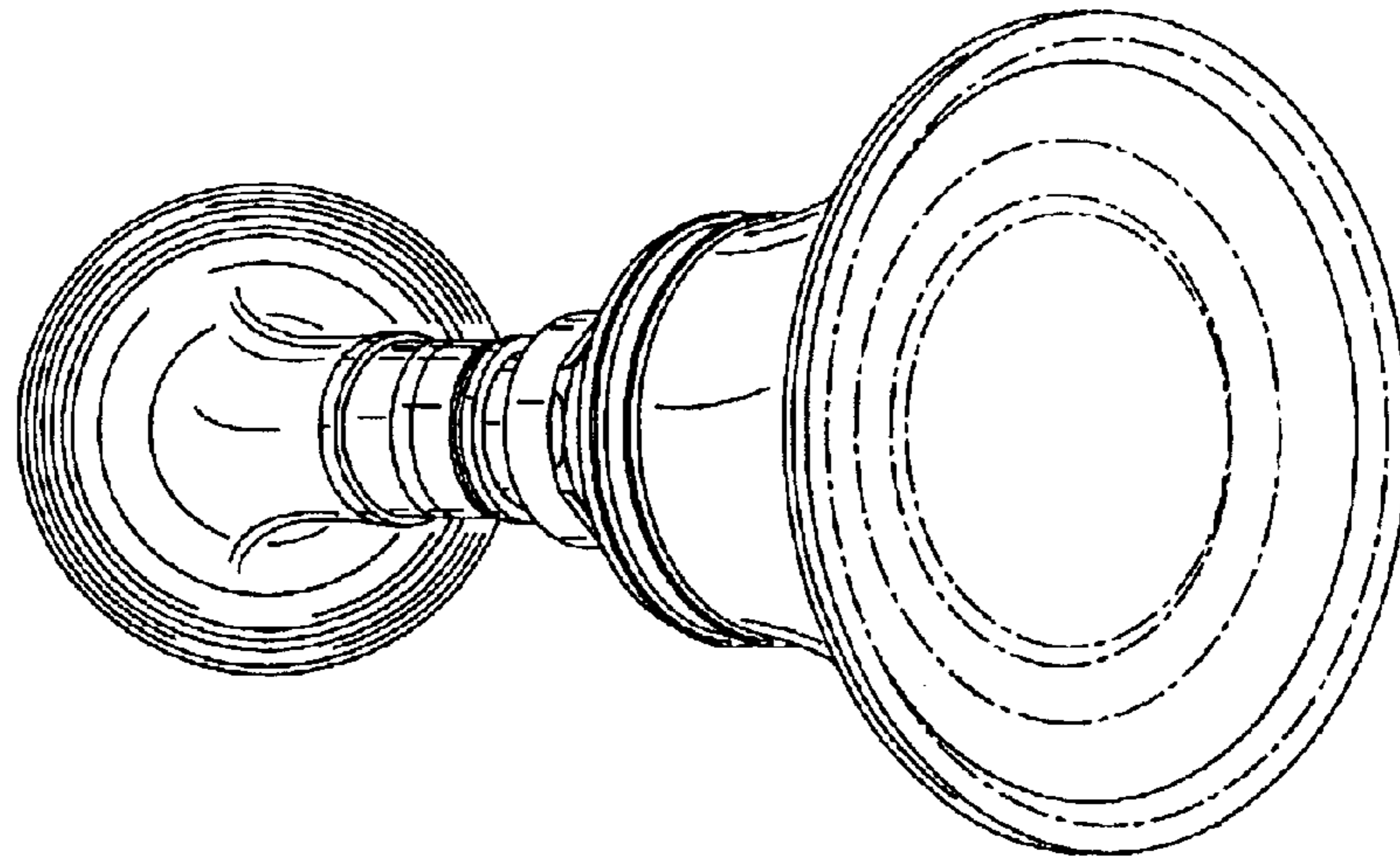

FIG. 4



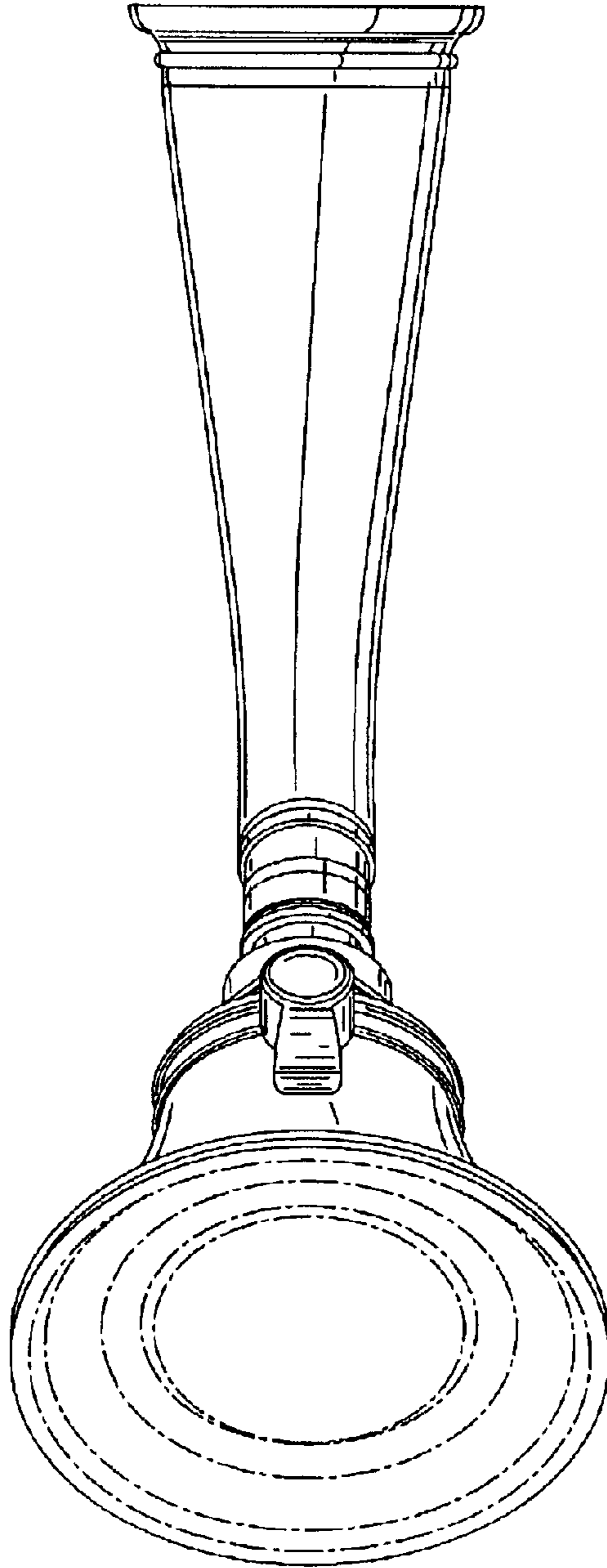

FIG. 6