



US00D487914S

(12) **United States Design Patent**  
**Schulze et al.**

(10) **Patent No.: US D487,914 S**  
(45) **Date of Patent: \*\* Mar. 30, 2004**

(54) **FILTER ELEMENT**

**DESCRIPTION**

(75) Inventors: **Andreas Schulze**, Hünfelden (DE);  
**Ernst Reder**, Hahnheim (DE); **Jurgen Malsy**, Rodgau (DE)

(73) Assignee: **Brita GmbH**, Taunusstein (DE)

(\*\*) Term: **14 Years**

(21) Appl. No.: **29/170,361**

(22) Filed: **Nov. 5, 2002**

(30) **Foreign Application Priority Data**

May 6, 2002 (WO) ..... DM/060 898

(51) **LOC (7) Cl.** ..... **23-01**

(52) **U.S. Cl.** ..... **D23/209**

(58) **Field of Search** ..... D23/365, 207,  
D23/209, 364; 210/282, 244, 443, 444,  
473, 474, 477

(56) **References Cited**

**U.S. PATENT DOCUMENTS**

3,950,251 A *	4/1976	Hiller	.....	210/232
4,915,831 A *	4/1990	Taylor	.....	210/232
D317,040 S *	5/1991	Petrucci et al.	.....	D23/209
D320,640 S *	10/1991	Goodwin	.....	D23/209
5,486,288 A *	1/1996	Stanford et al.	.....	210/235
D377,825 S *	2/1997	Booth et al.	.....	D23/209

\* cited by examiner

*Primary Examiner*—Robin V. Taylor

(74) *Attorney, Agent, or Firm*—Hudak, Shunk & Farine,  
Co. LPA

(57) **CLAIM**

We claim the ornamental design for a filter element, as shown.

FIG. 1 is a front perspective view of filter and lid with measuring device  
 FIG. 2 is a rear perspective view thereof  
 FIG. 3 is a front plan view thereof  
 FIG. 4 is a rear plan view thereof  
 FIG. 5 is a left plan view thereof  
 FIG. 6 is right plan view thereof  
 FIG. 7 is a top plan view thereof  
 FIG. 8 is a bottom plan view thereof  
 FIG. 9 is a front perspective view of filter and lid without measuring device  
 FIG. 10 is a rear perspective view thereof  
 FIG. 11 is a front plan view thereof  
 FIG. 12 is a rear plan view thereof  
 FIG. 13 is a left plan view thereof  
 FIG. 14 is a right plan view thereof  
 FIG. 15 is a top plan view thereof  
 FIG. 16 is a bottom plan view thereof  
 FIG. 17 is a front perspective view of lid with measuring device  
 FIG. 18 is a rear perspective view thereof  
 FIG. 19 is a front plan view thereof  
 FIG. 20 is a rear plan view thereof  
 FIG. 21 is a left plan view thereof  
 FIG. 22 is a right plan view thereof  
 FIG. 23 is a top plan view thereof  
 FIG. 24 is a bottom plan view thereof  
 FIG. 25 is a front perspective view of lid without measuring device  
 FIG. 26 is a rear perspective view thereof  
 FIG. 27 is a front plan view thereof  
 FIG. 28 is a rear plan view thereof  
 FIG. 29 is a left plan view thereof  
 FIG. 30 is a right plan view thereof  
 FIG. 31 is a top plan view thereof; and,  
 FIG. 32 is a bottom plan view thereof.

**1 Claim, 22 Drawing Sheets**

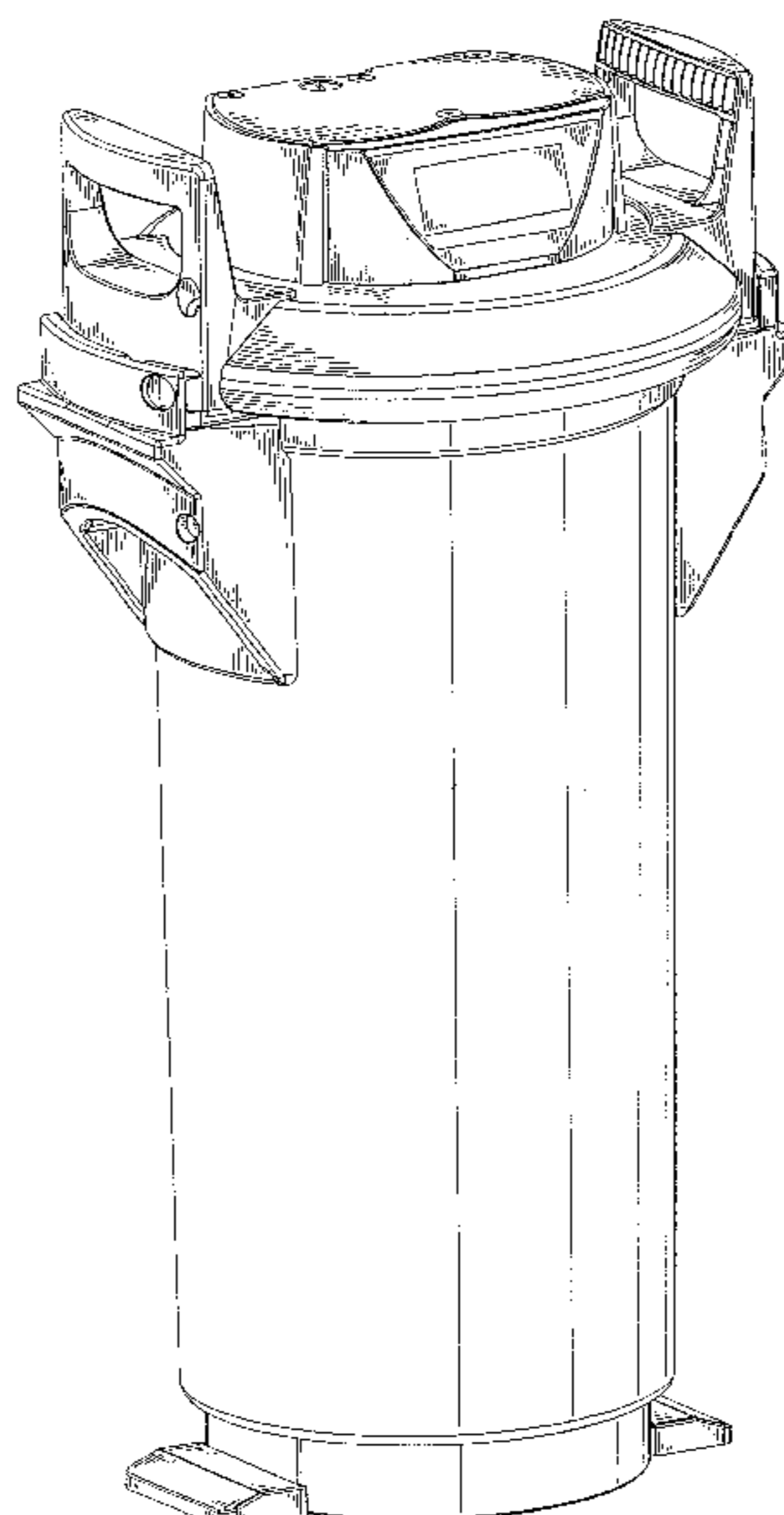

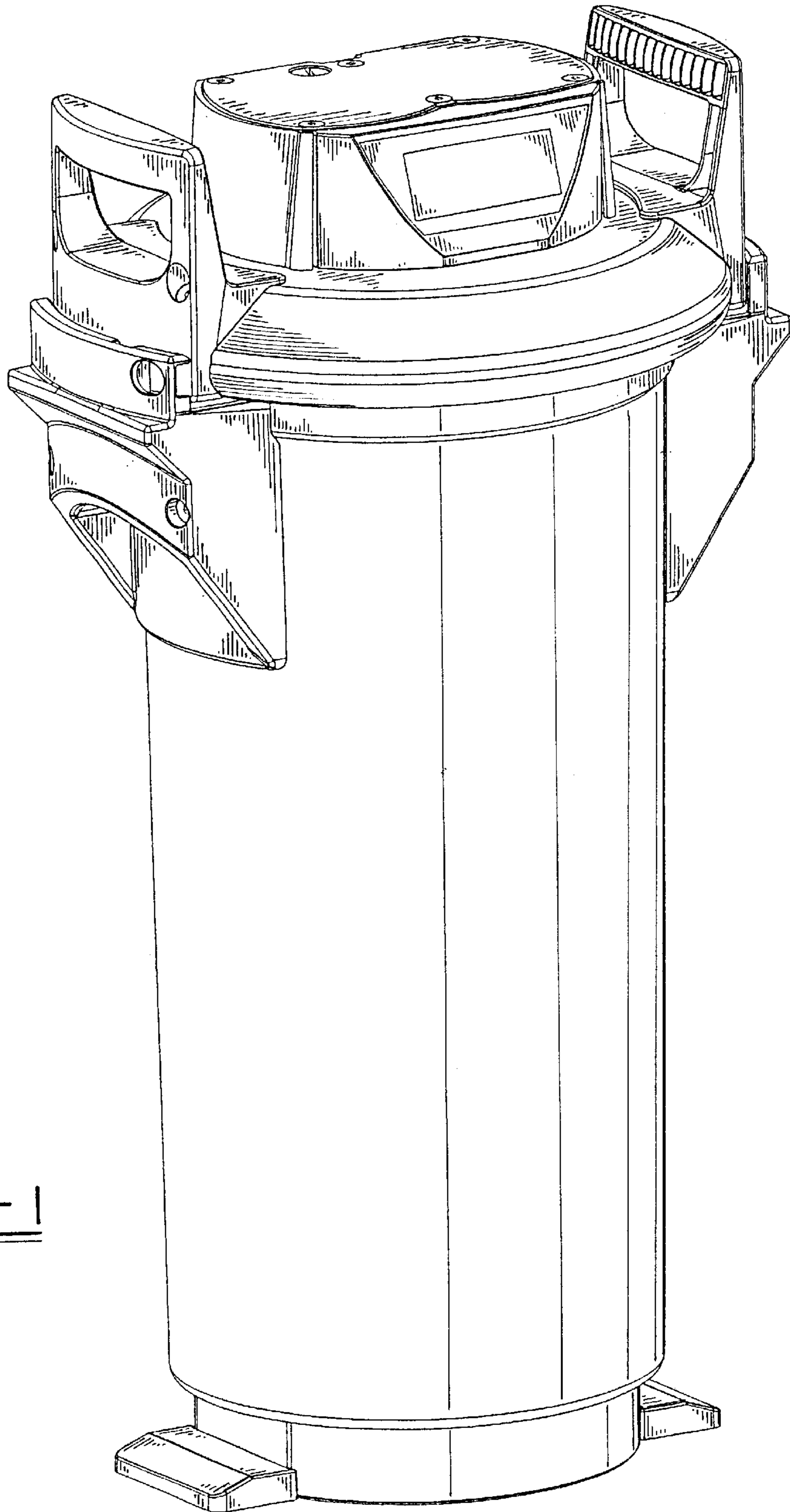

FIG. - 1

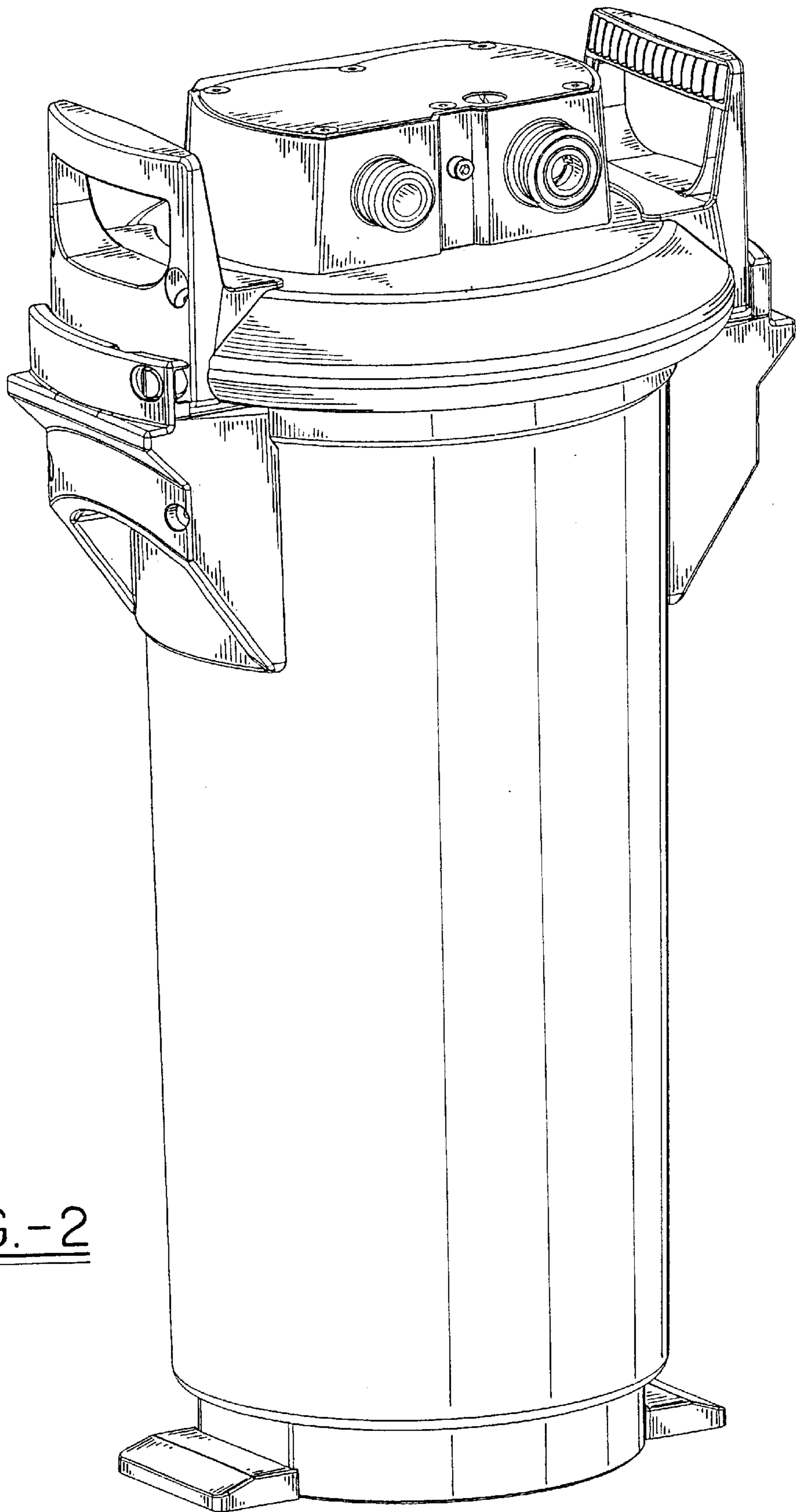

FIG.-2

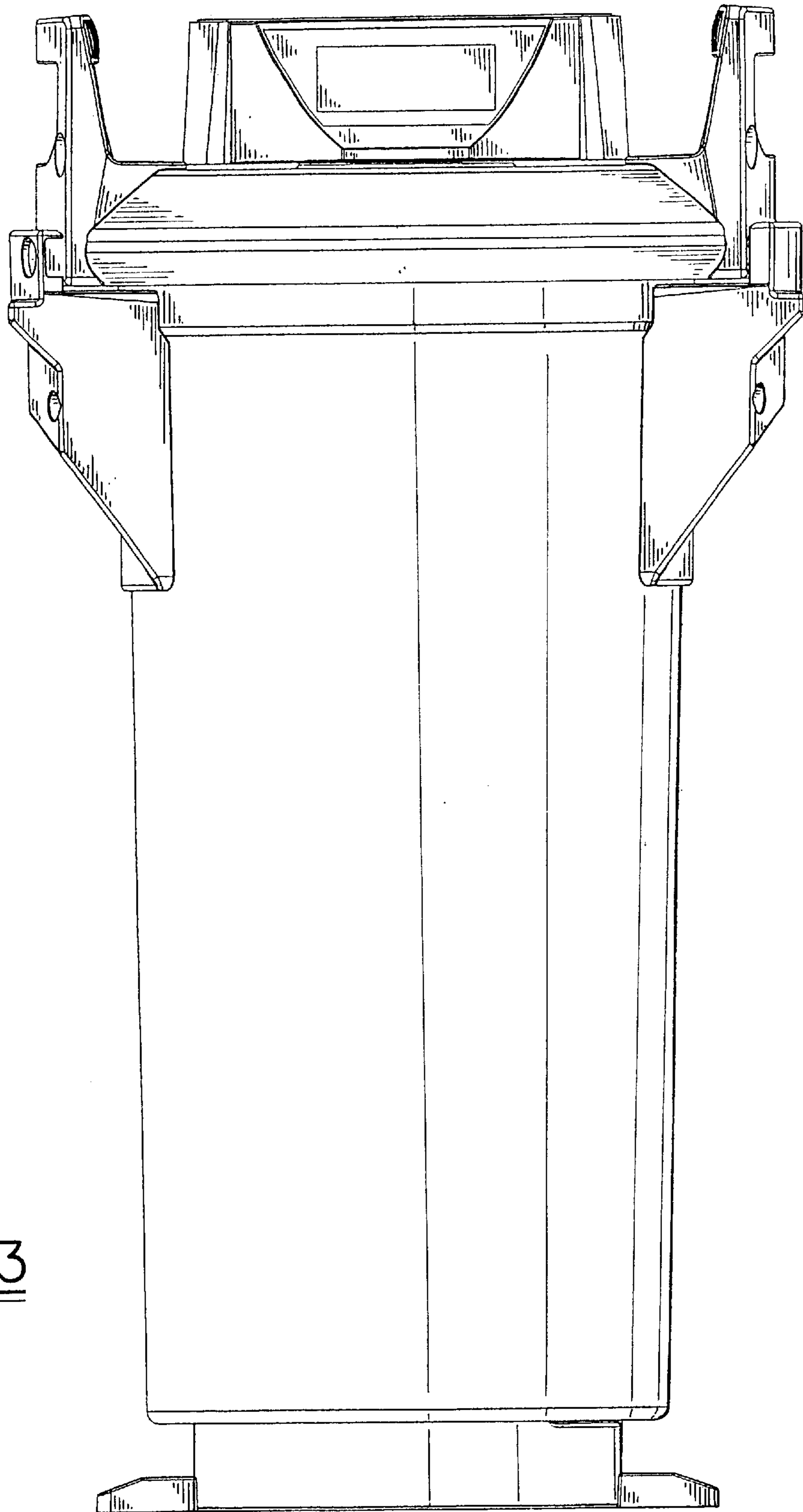

FIG. - 3



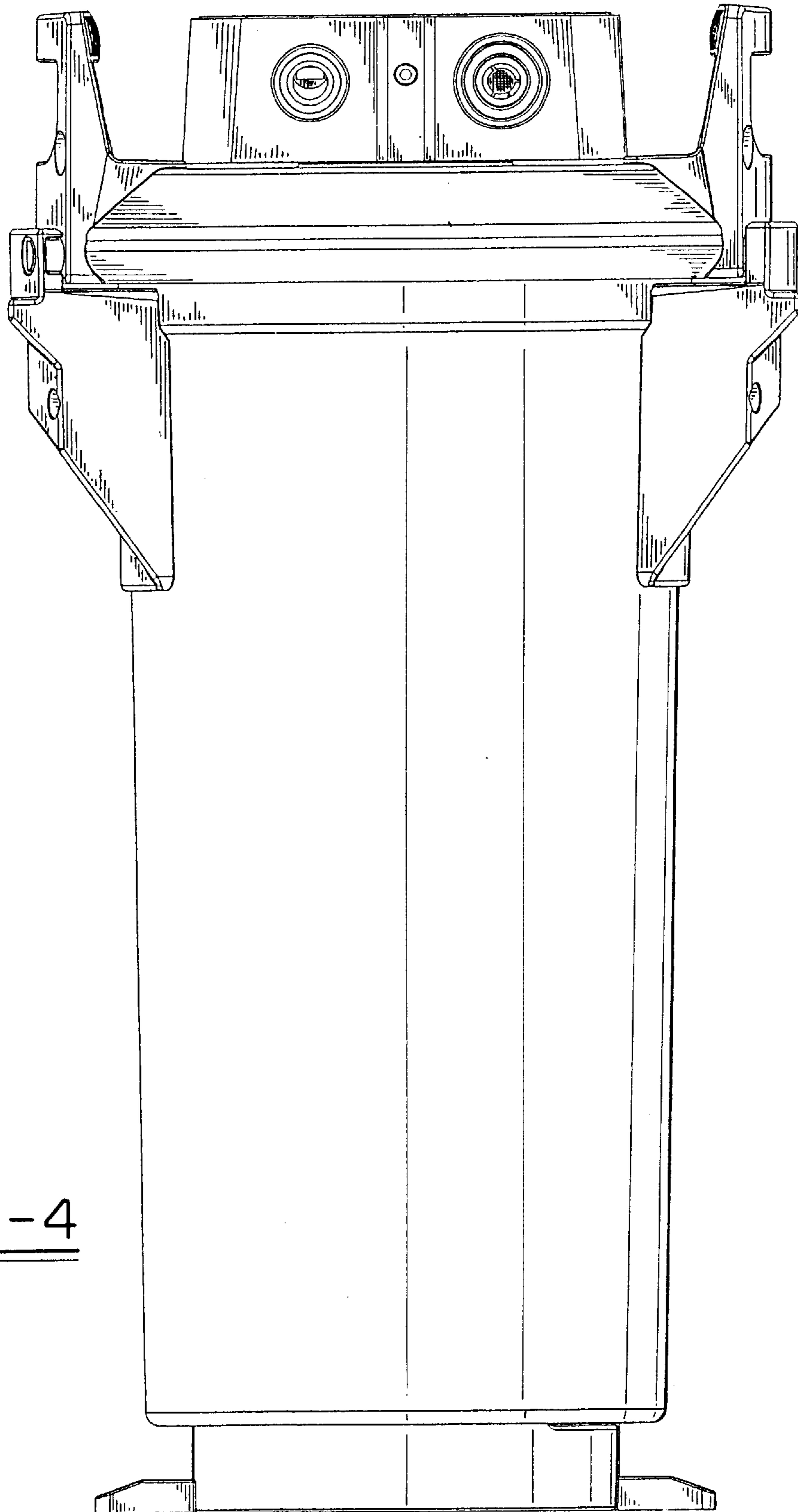

FIG.-4

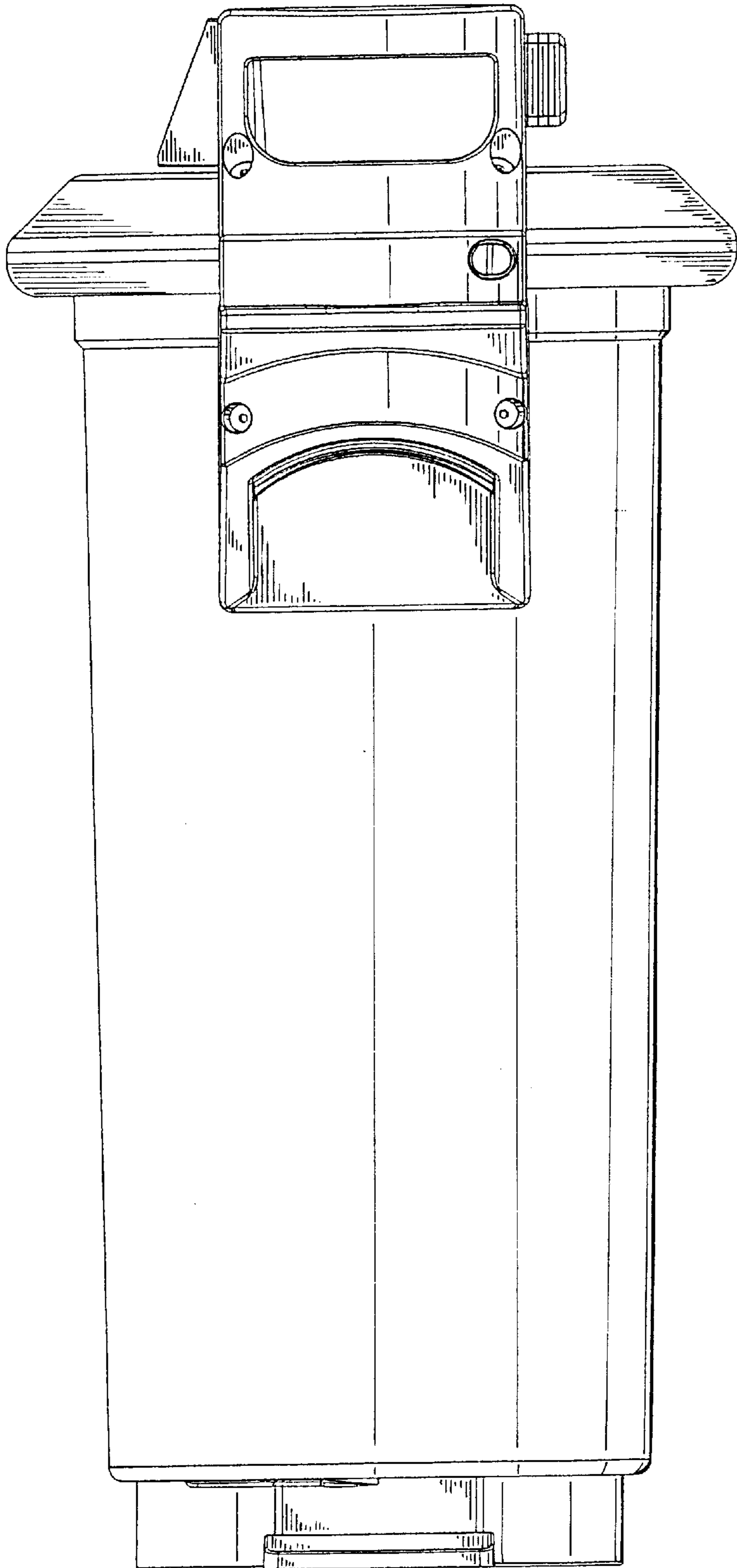

FIG. -5

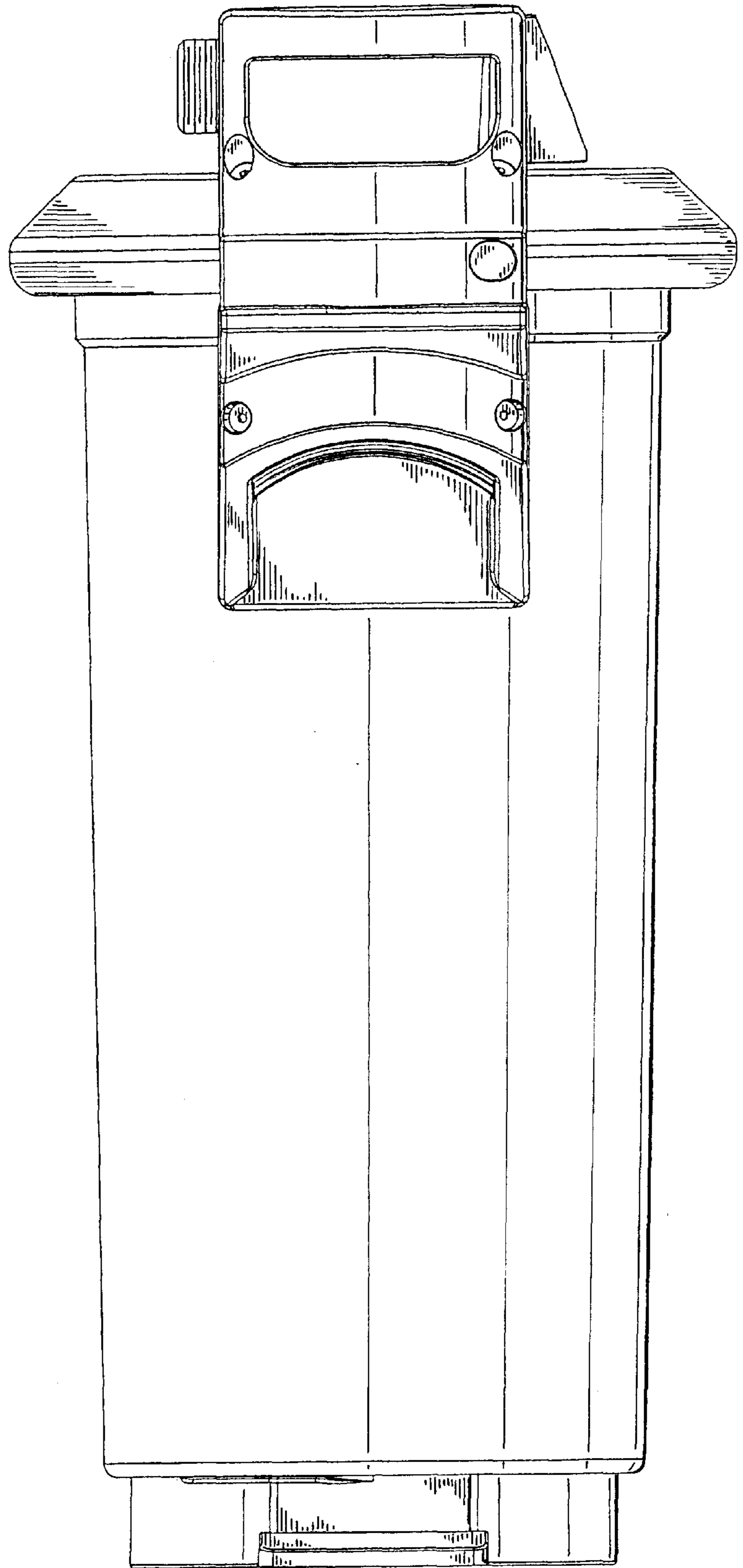

FIG. -6

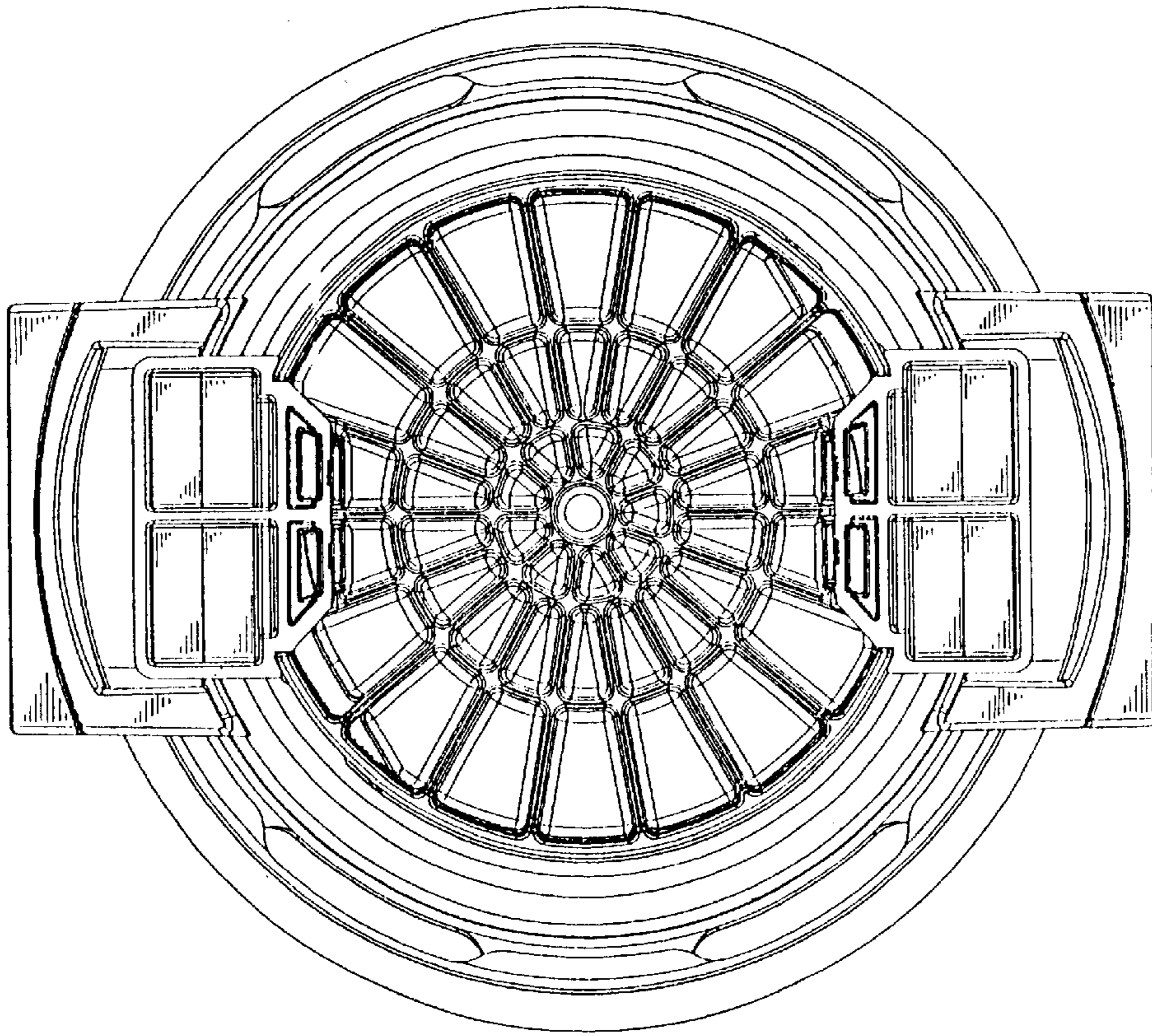

FIG. -8

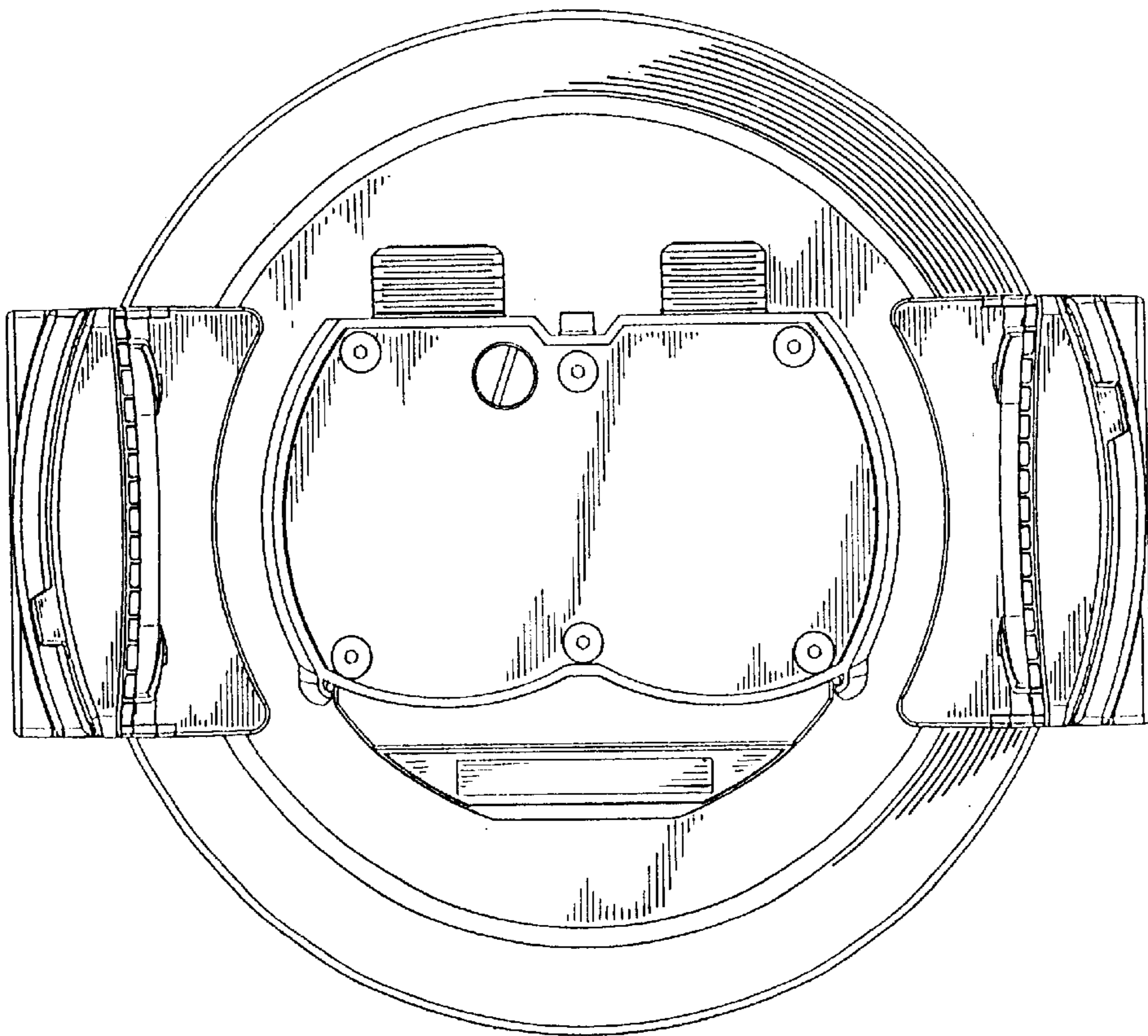

FIG. -7



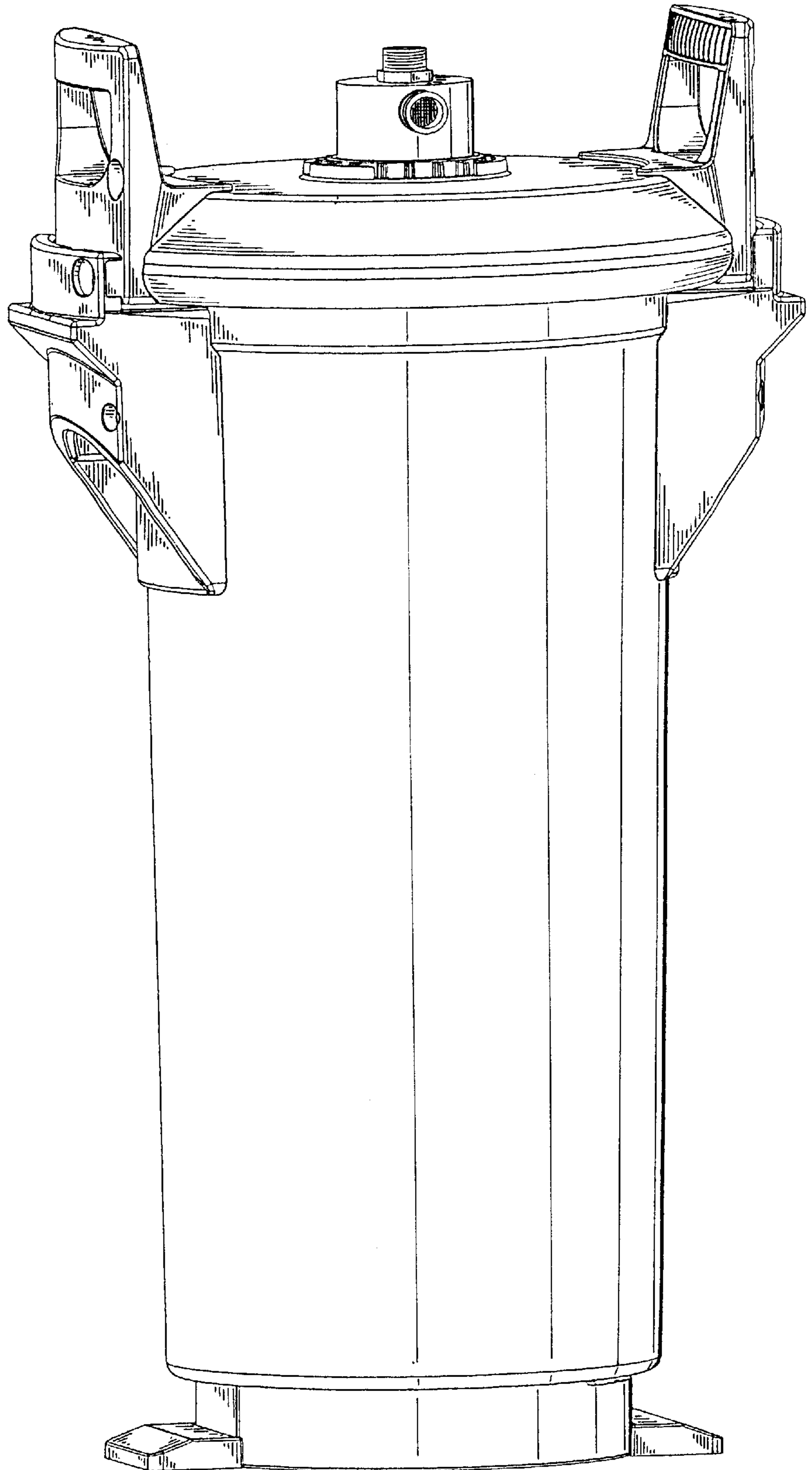

FIG. -9

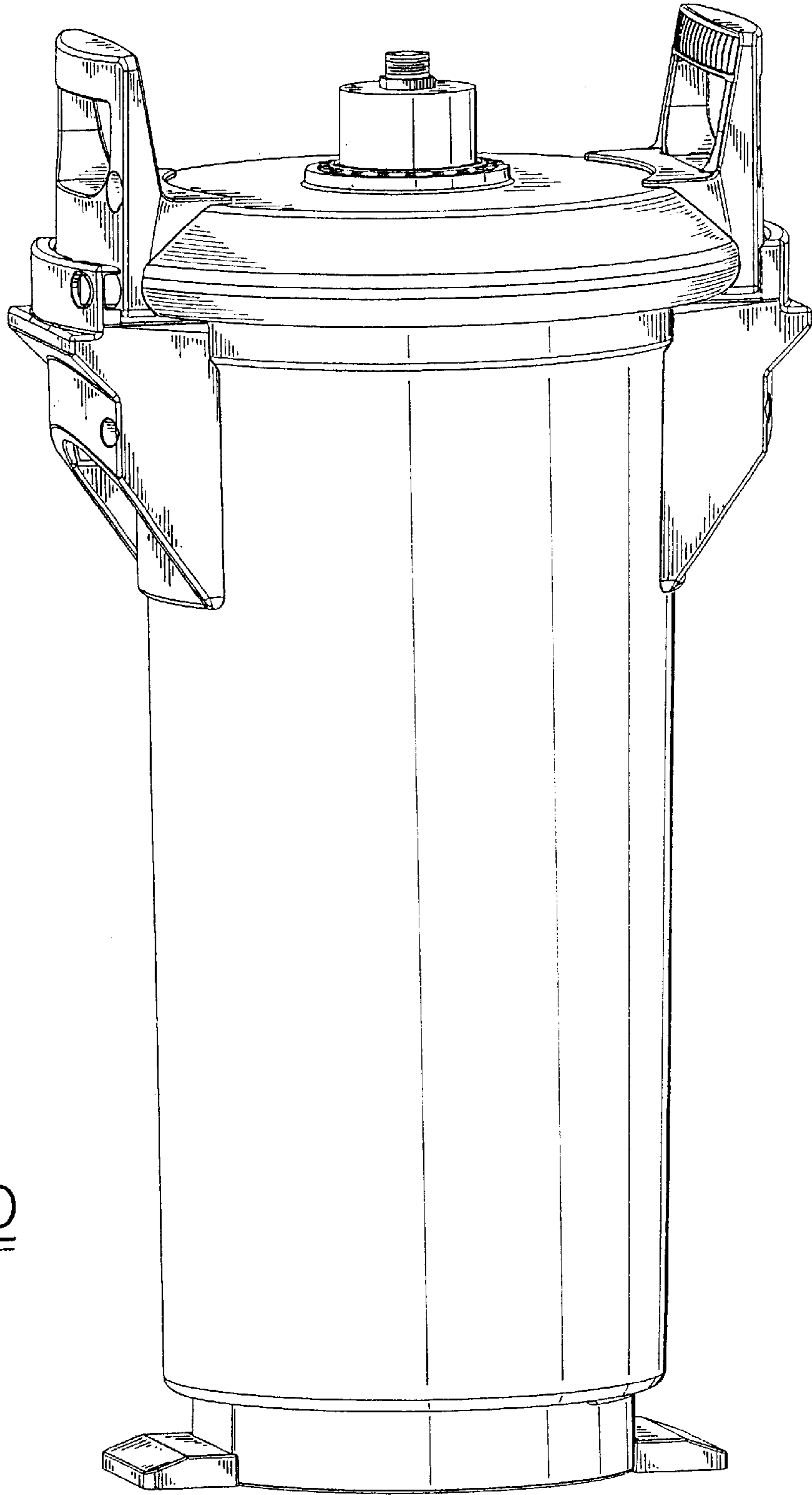

FIG.-10

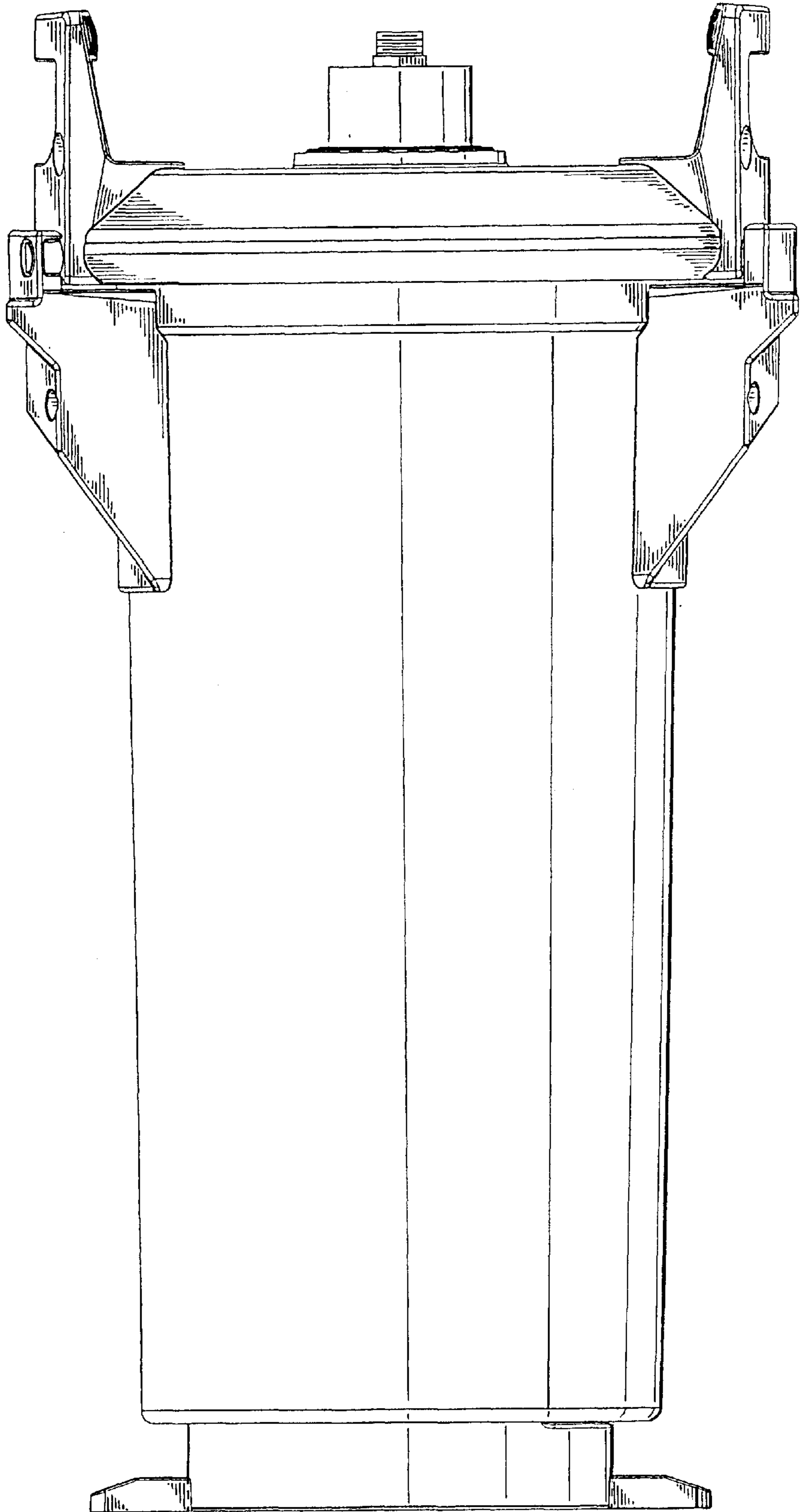

FIG.-11

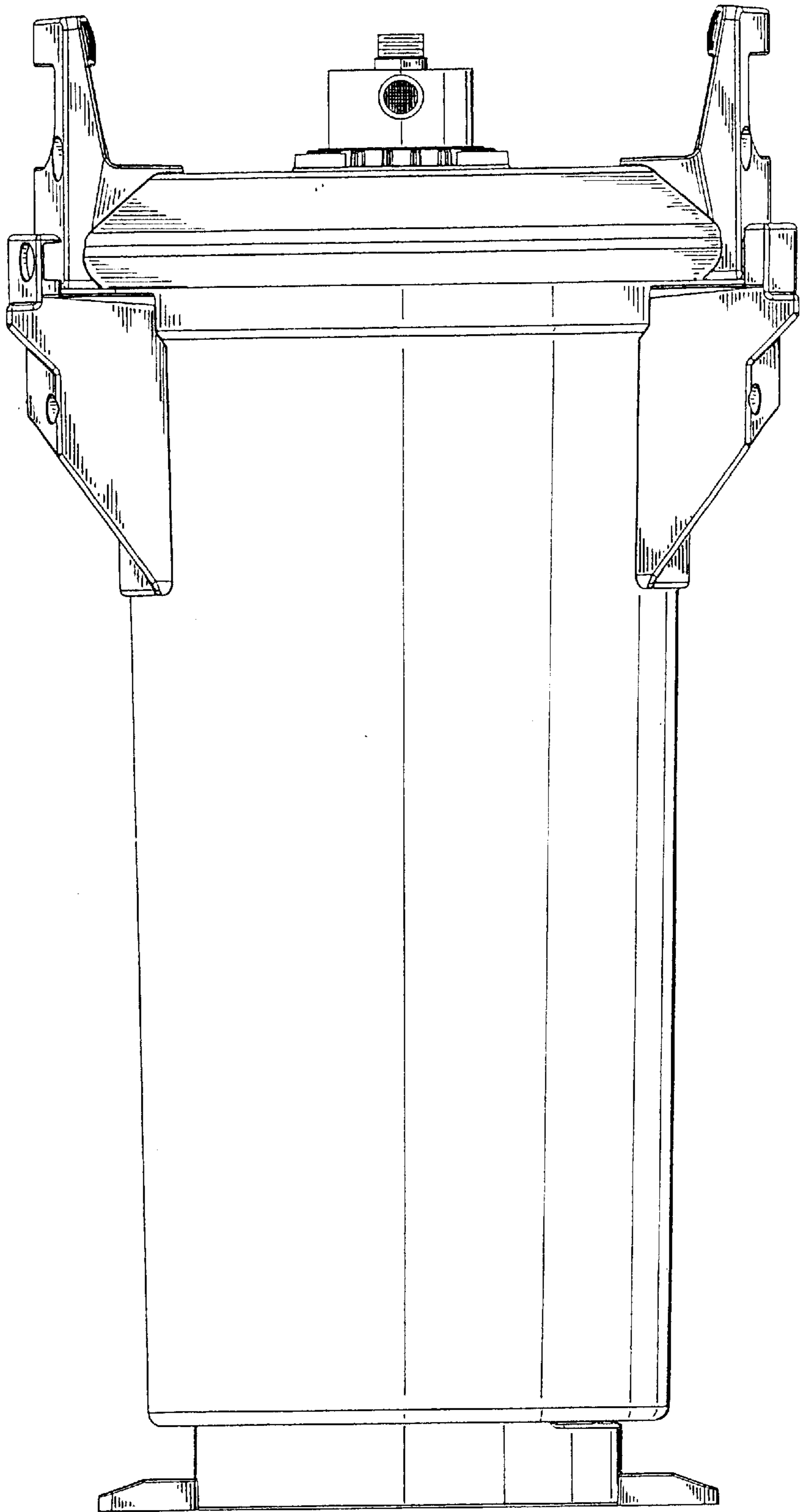

FIG.-12



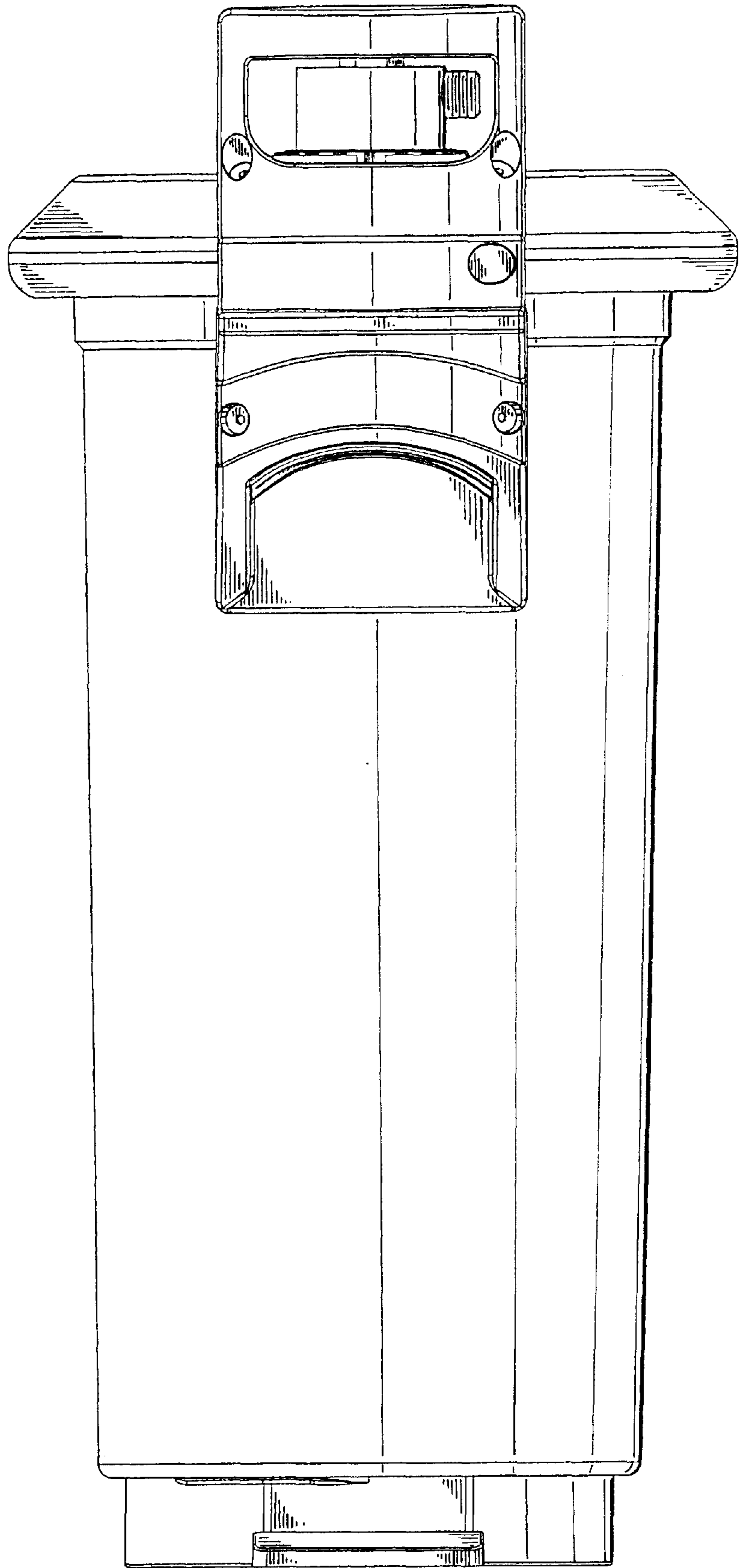

FIG.-13

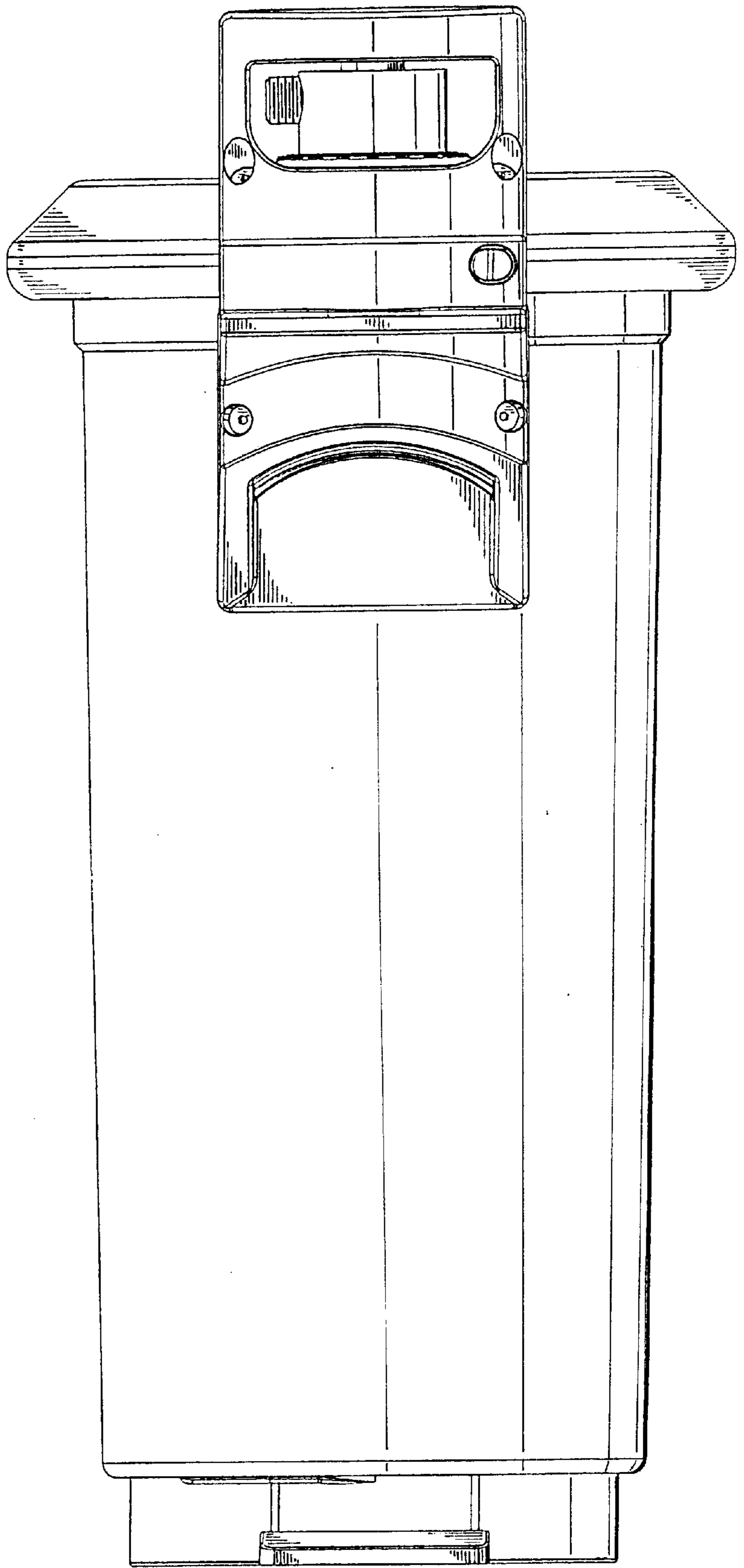

FIG. -14

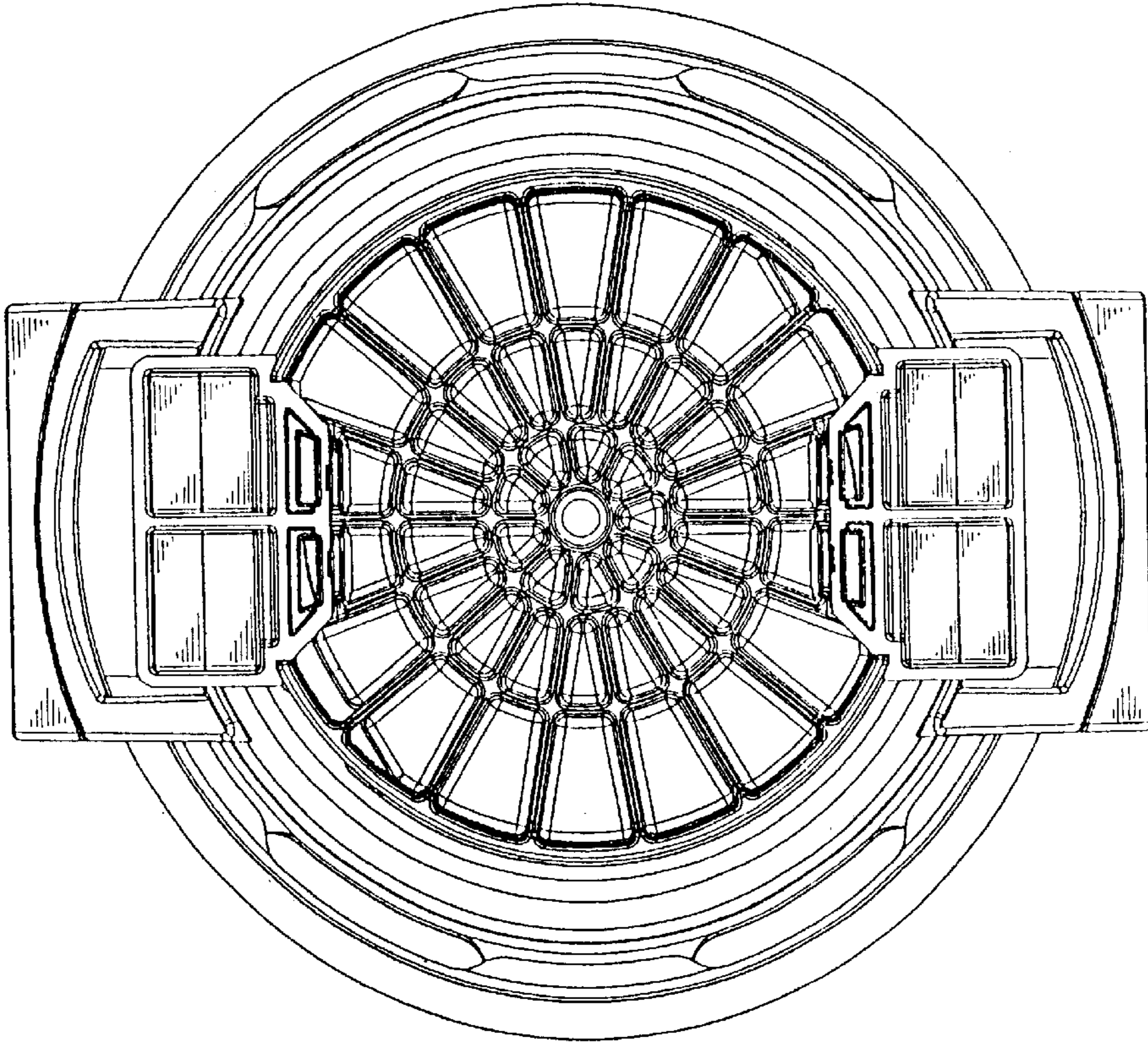

FIG. -16

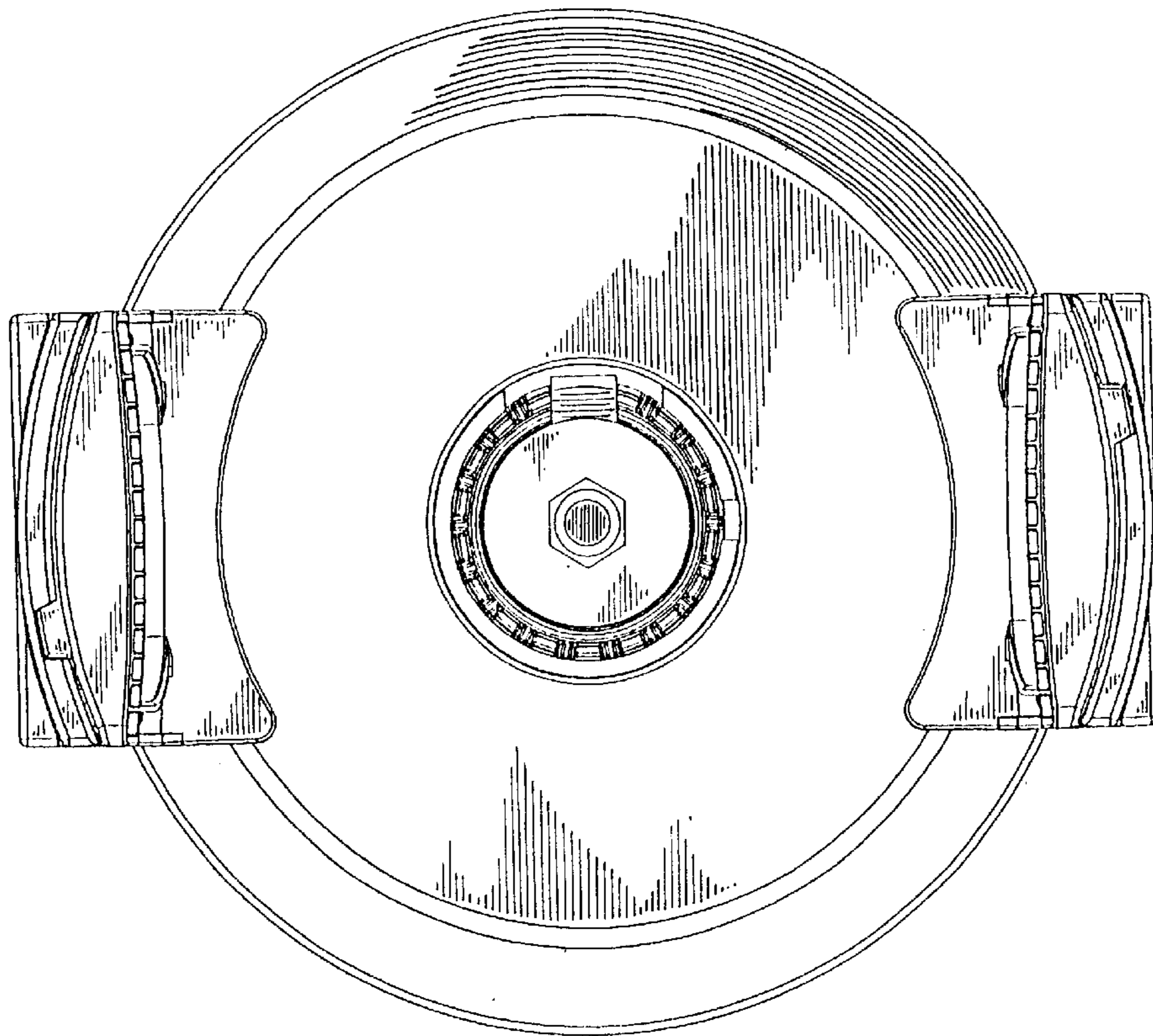

FIG. -15



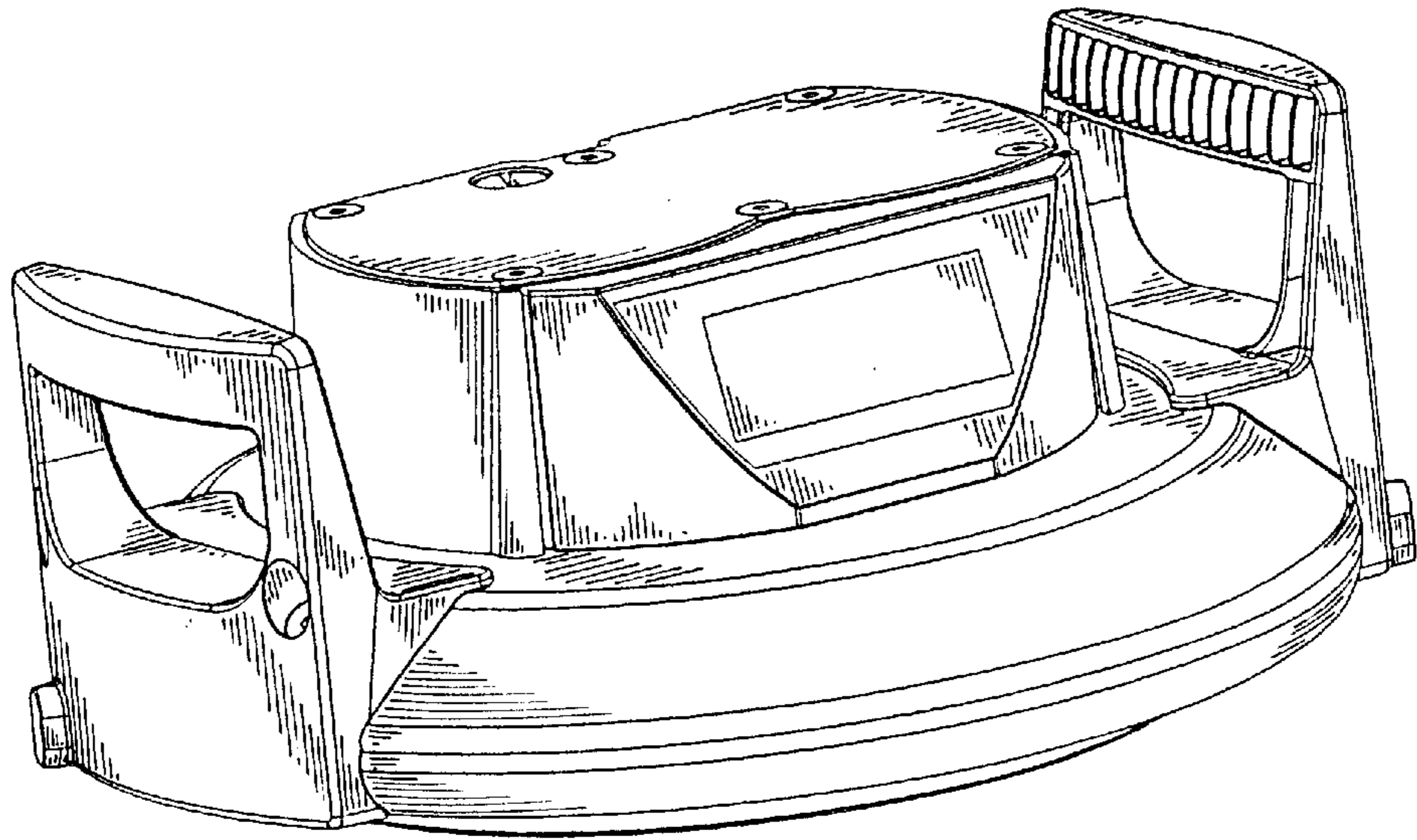

FIG.-17

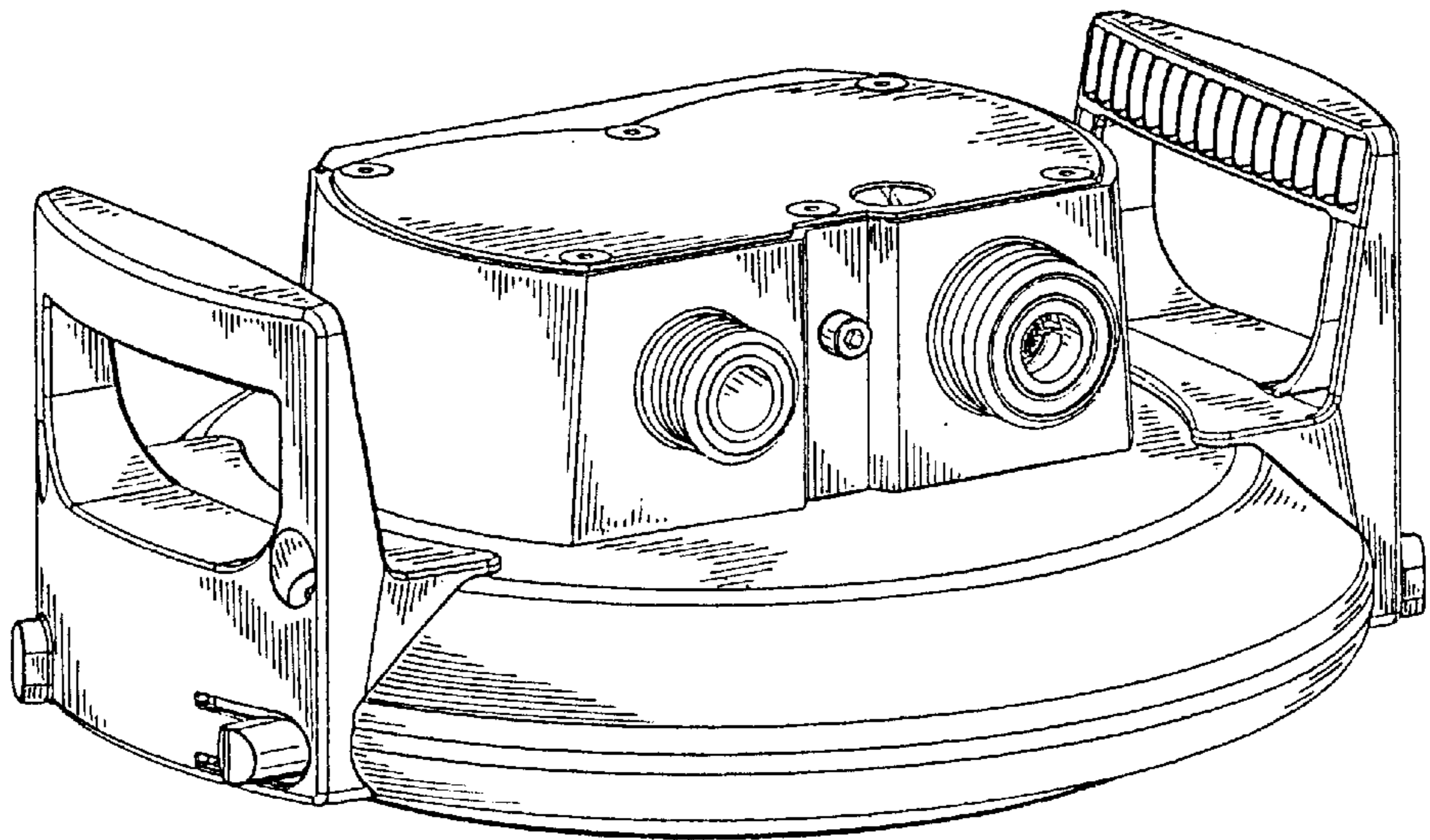

FIG.-18



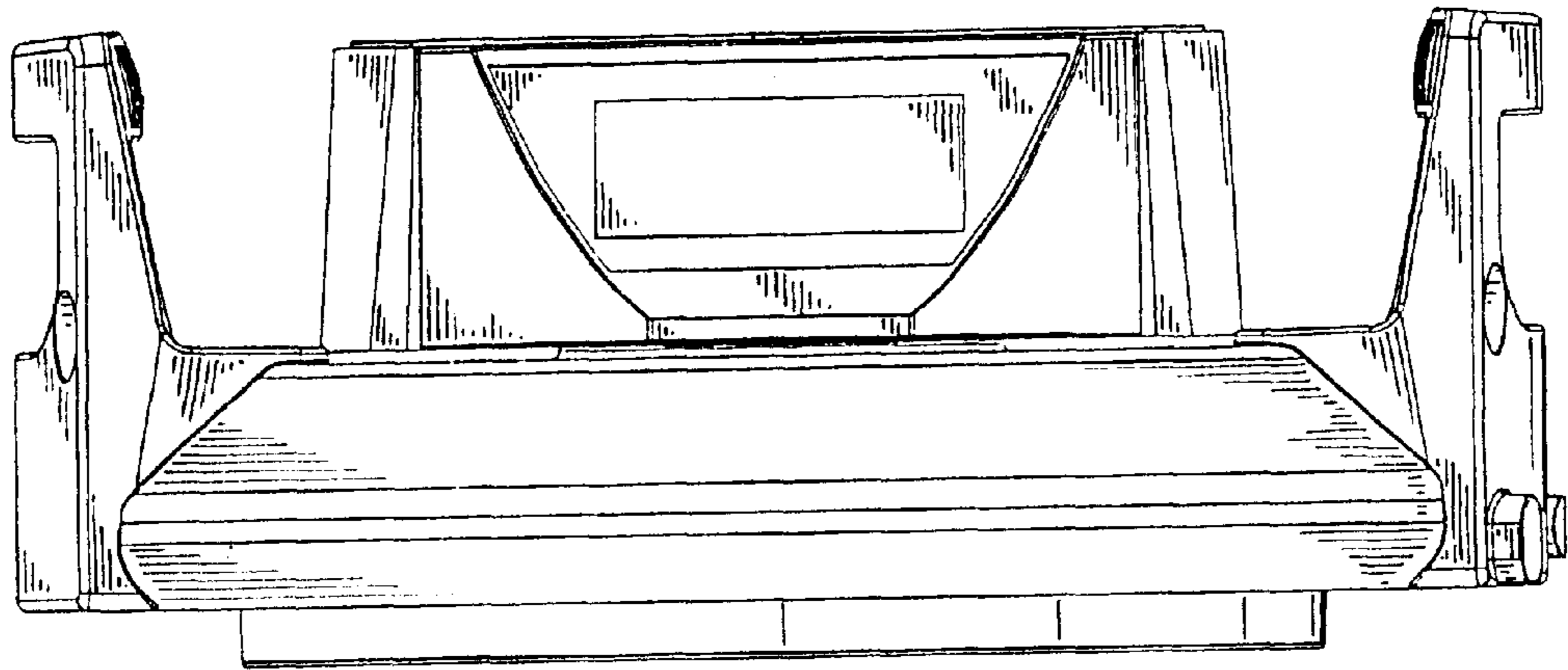

FIG.-19

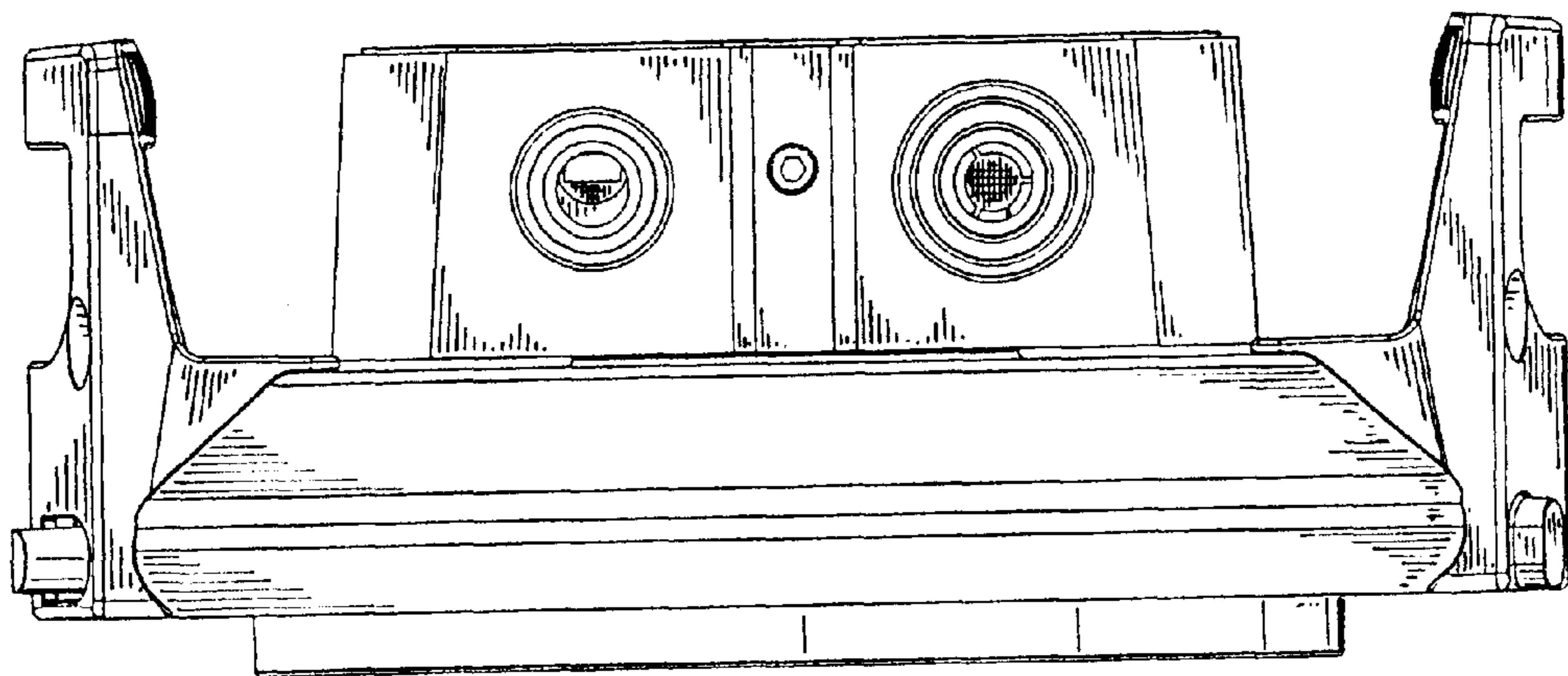

FIG.-20

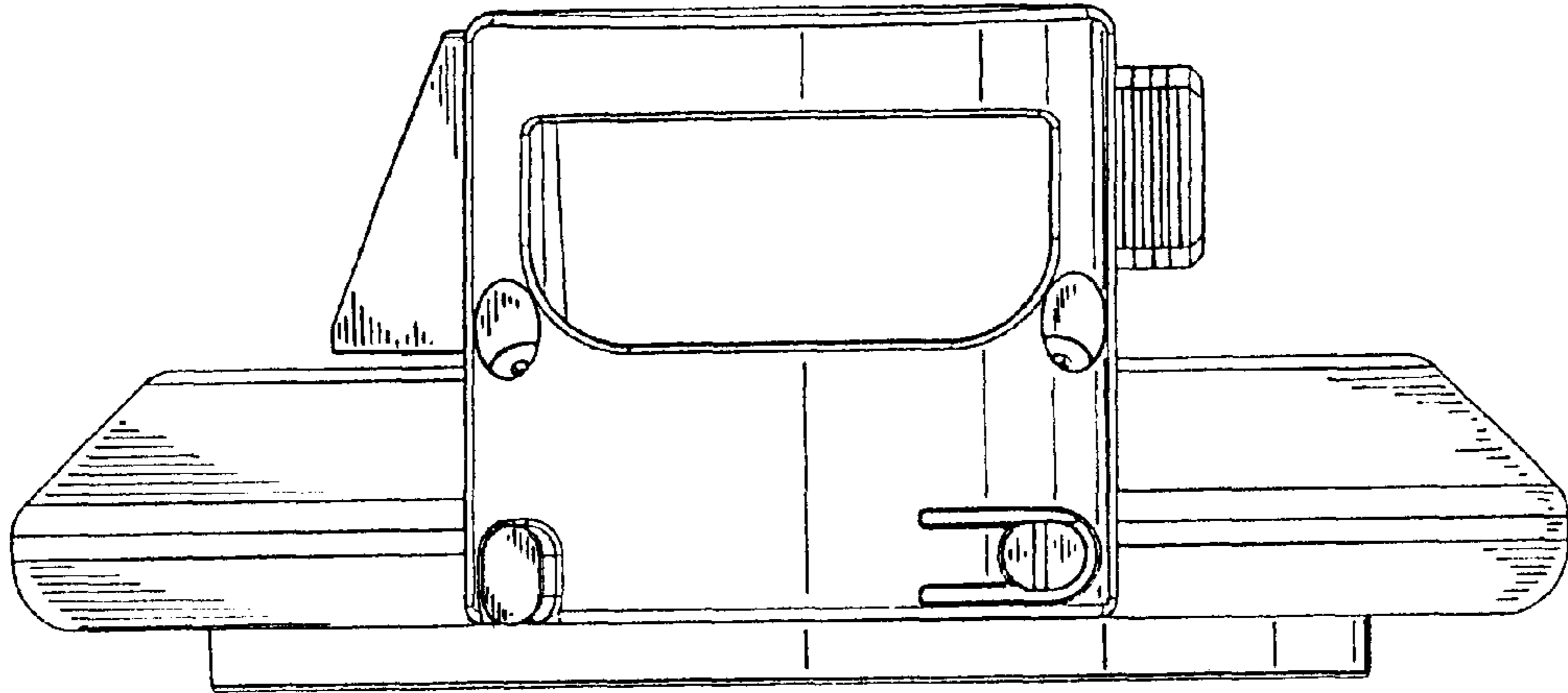

FIG.-21

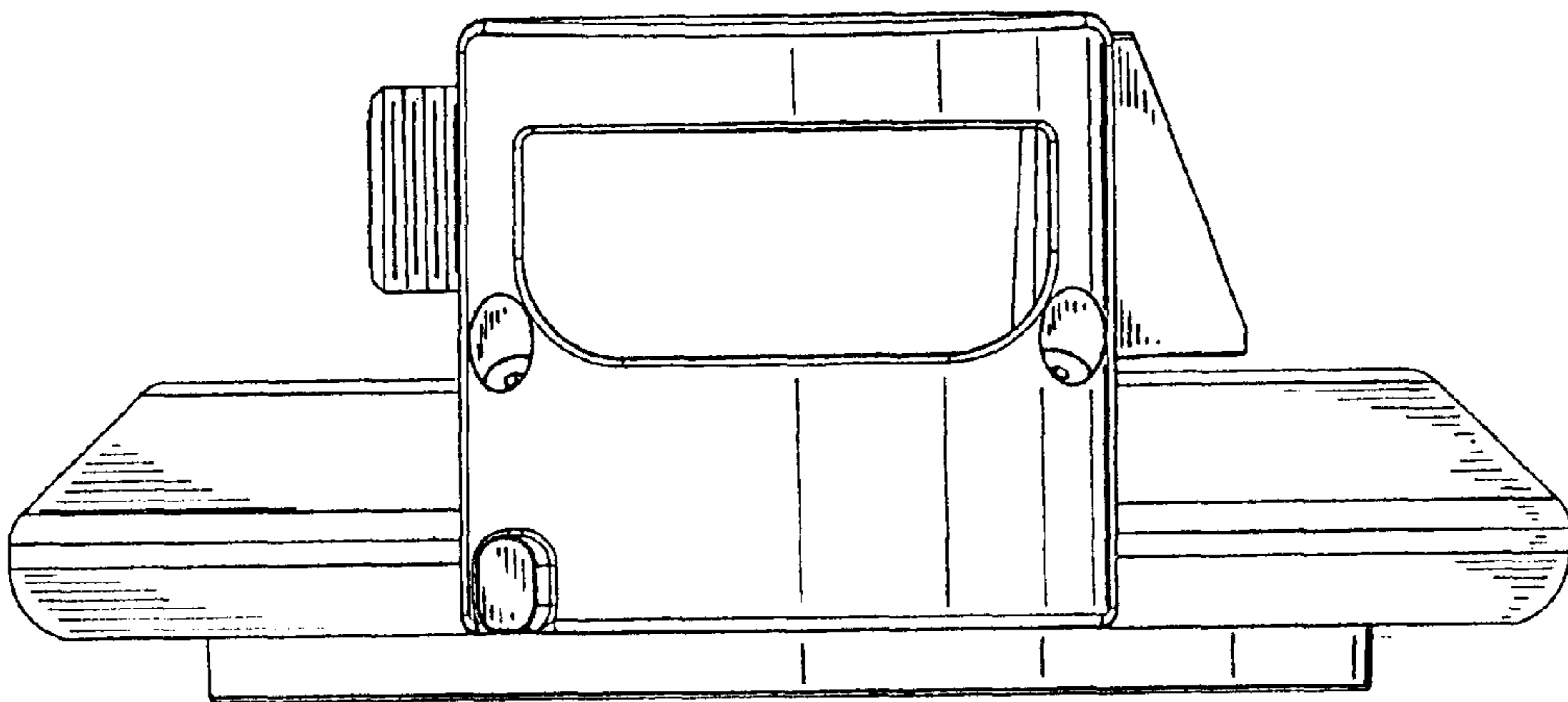

FIG.-22

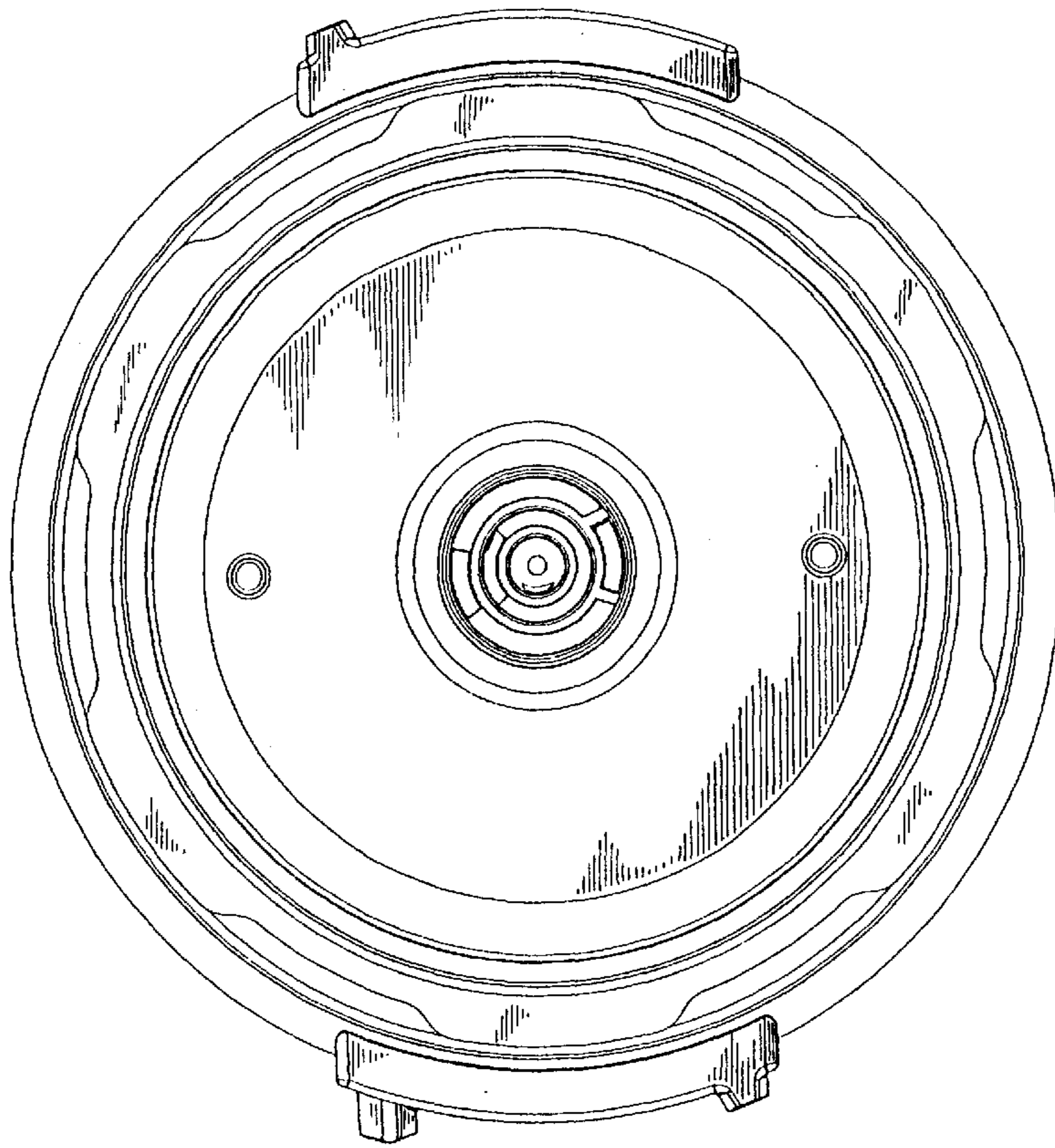

FIG. - 24

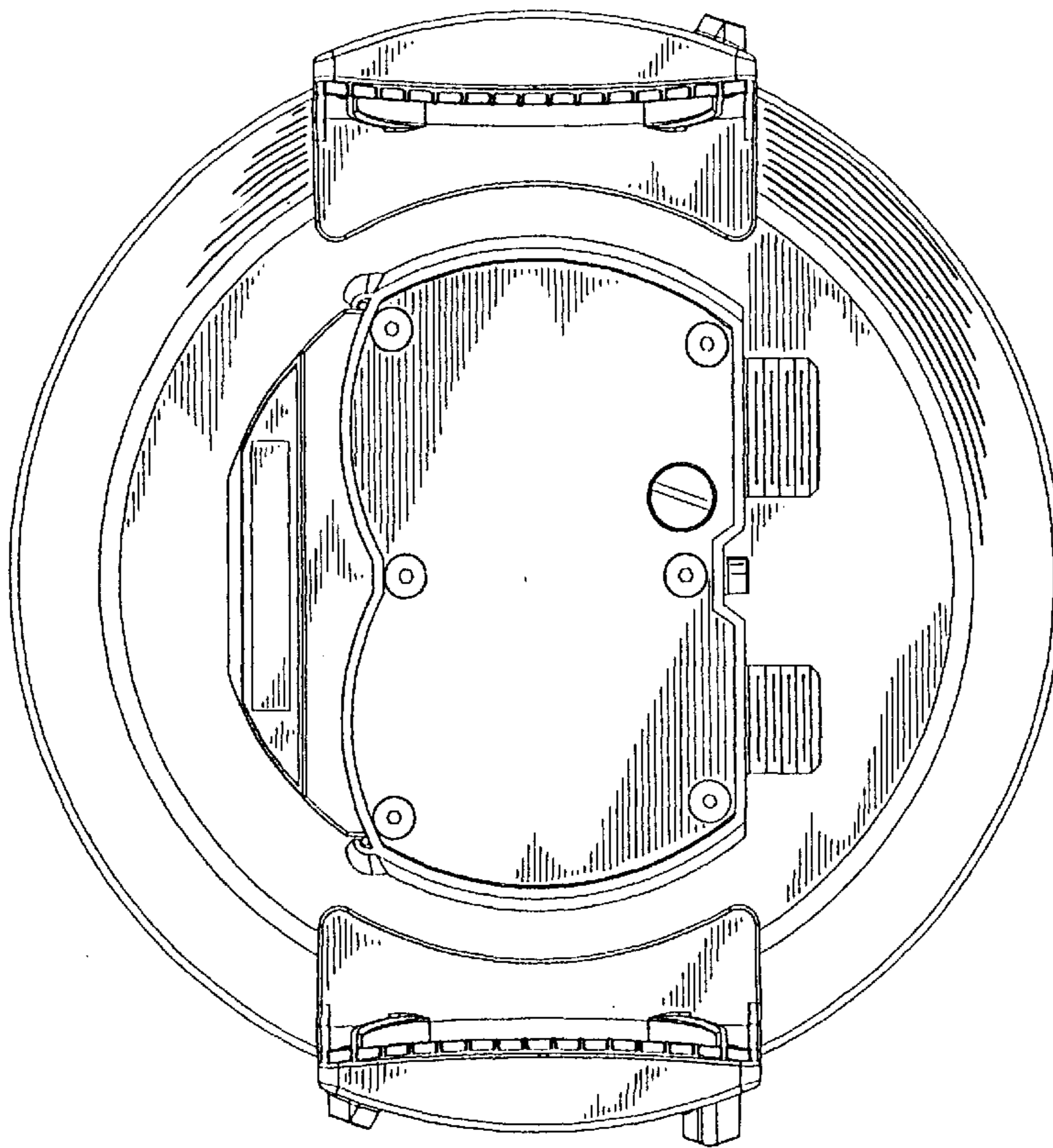

FIG. - 23

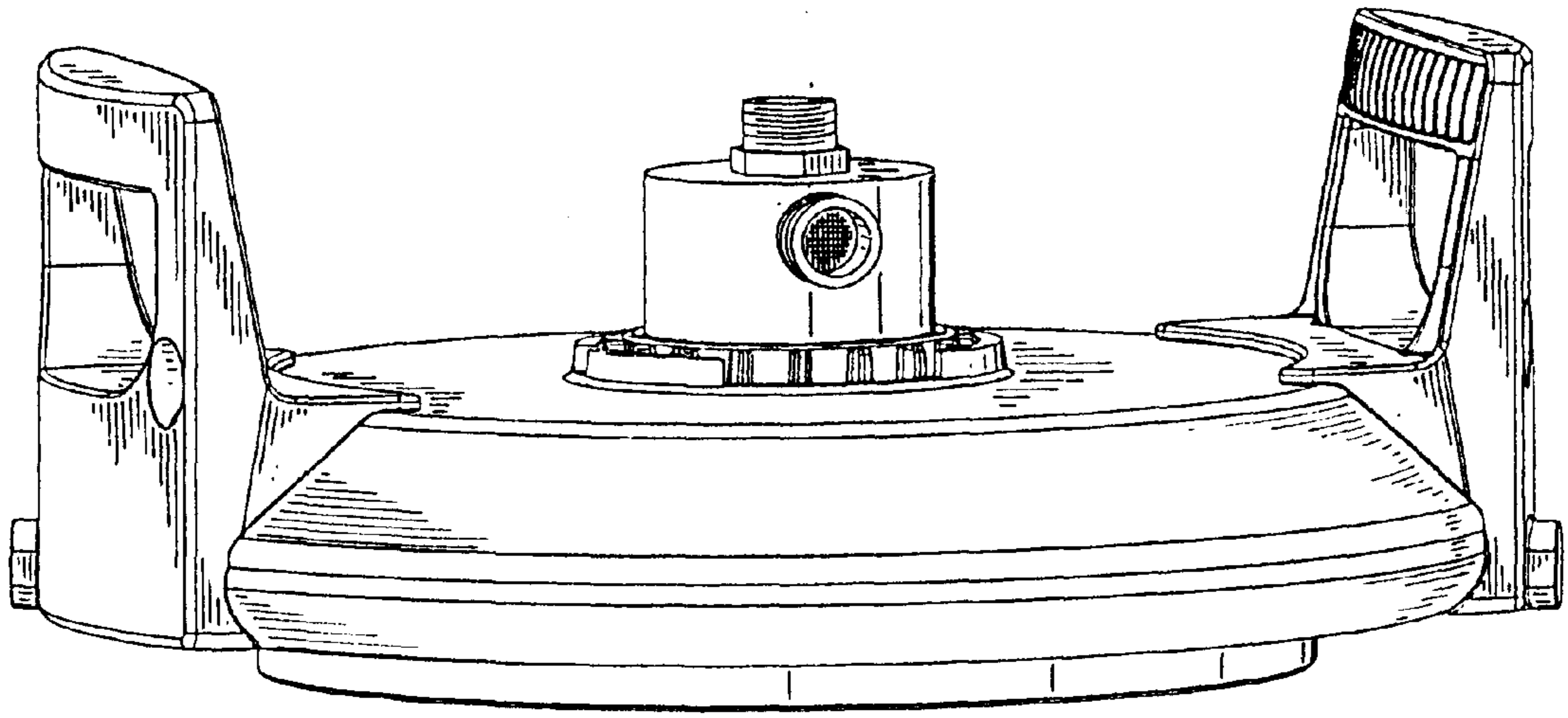

FIG. -25

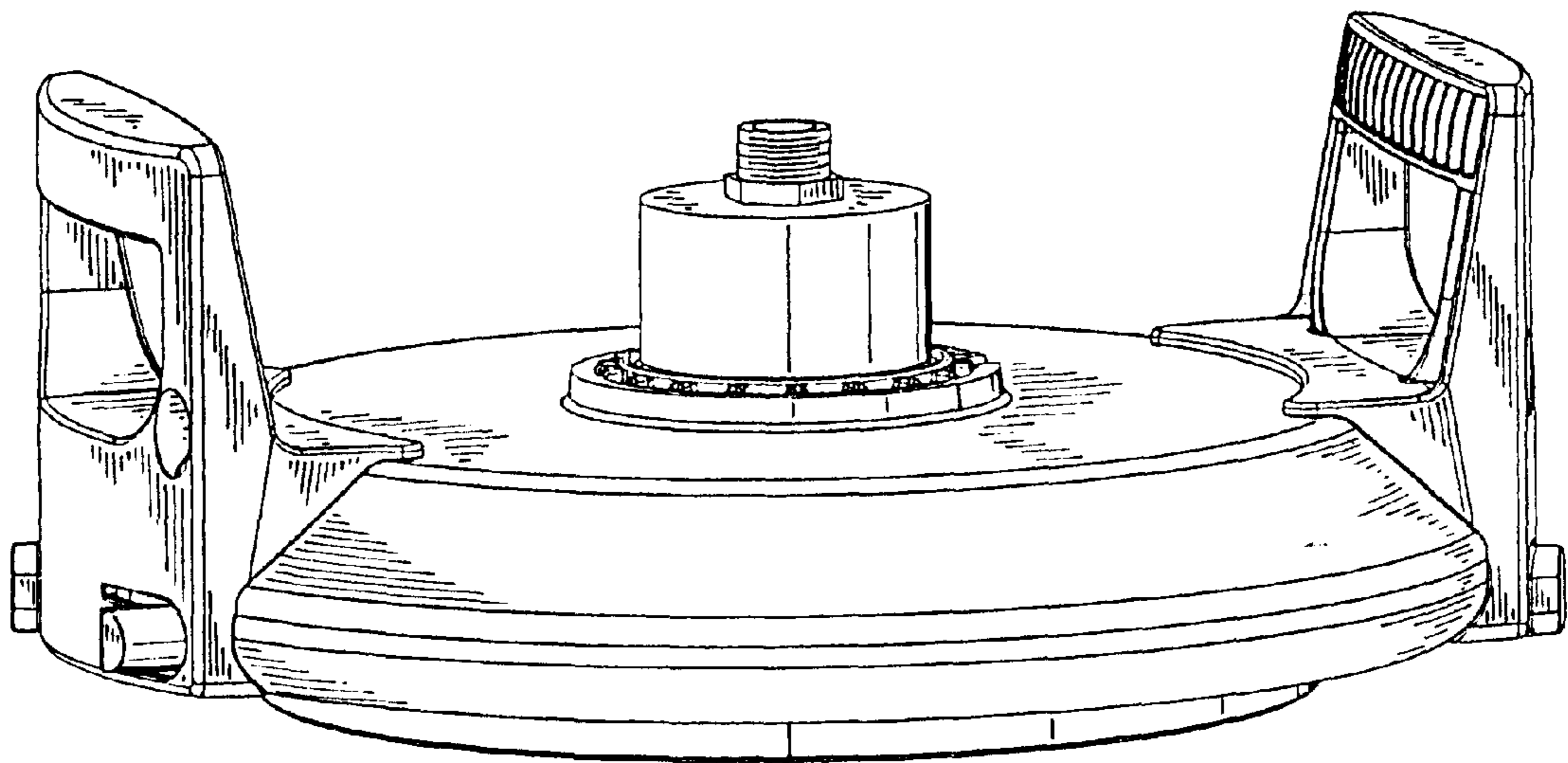

FIG. -26



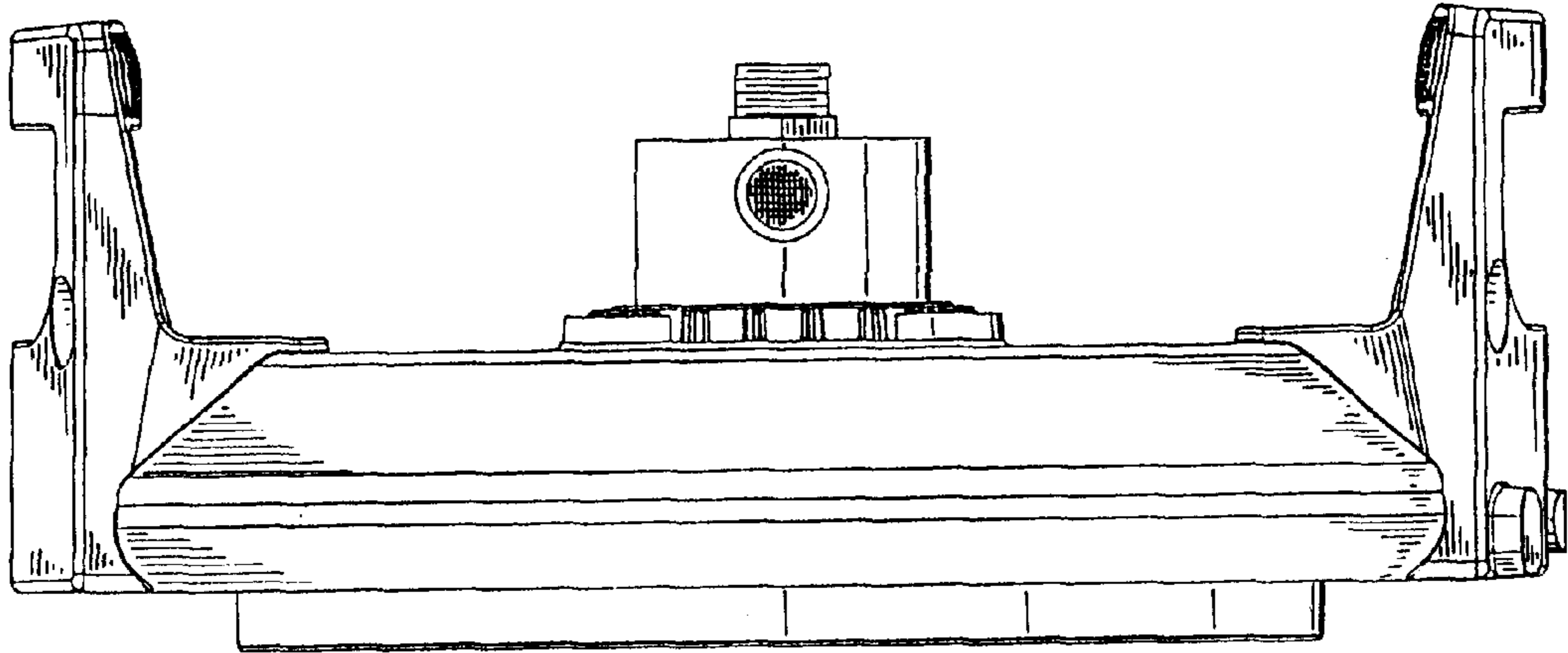

FIG.-27

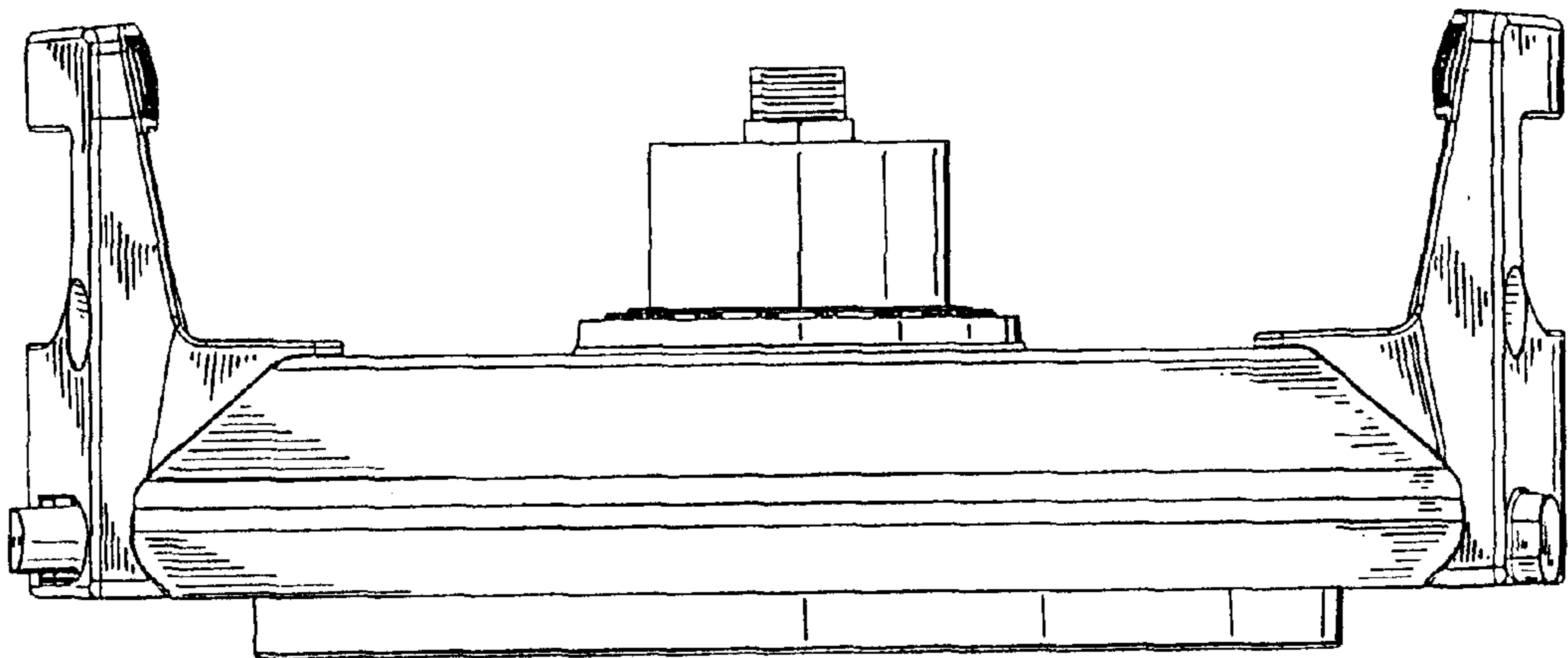

FIG.-28

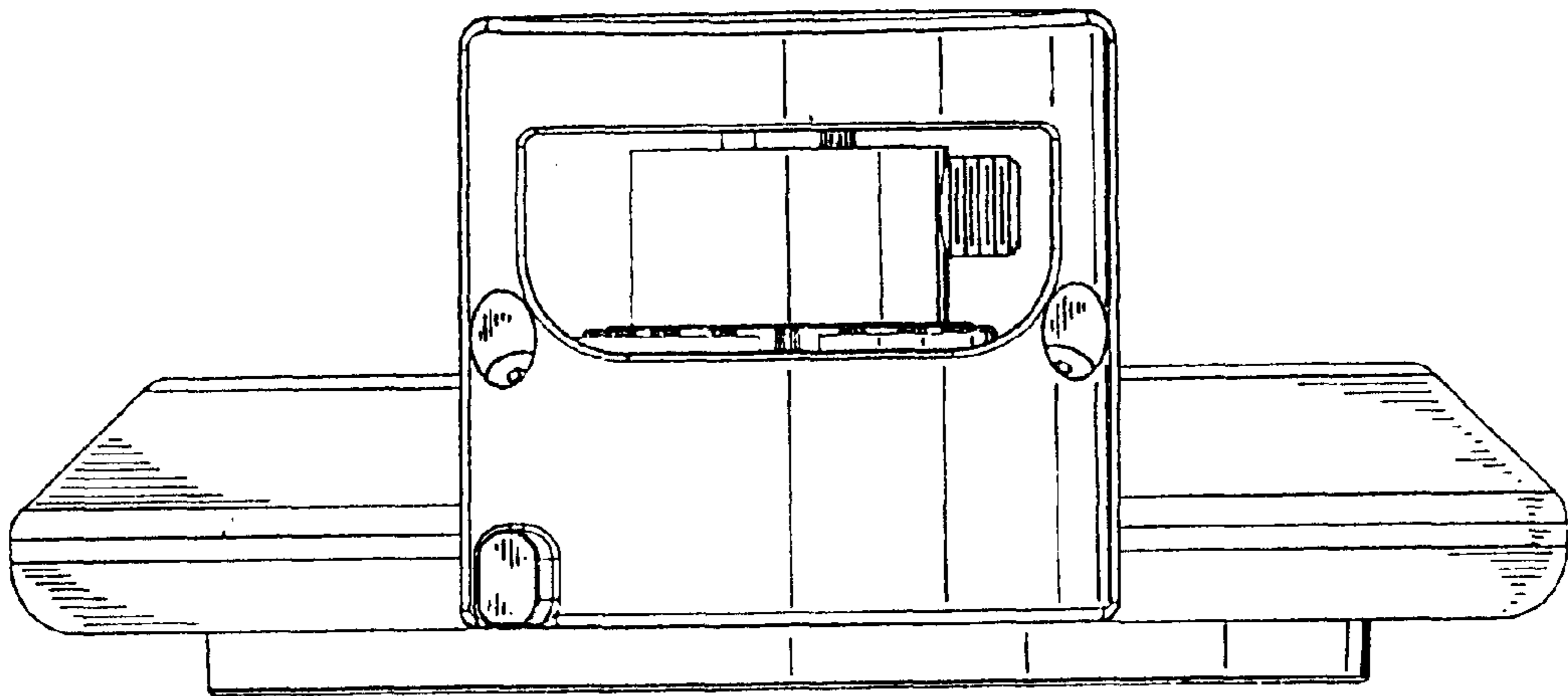

FIG. -29

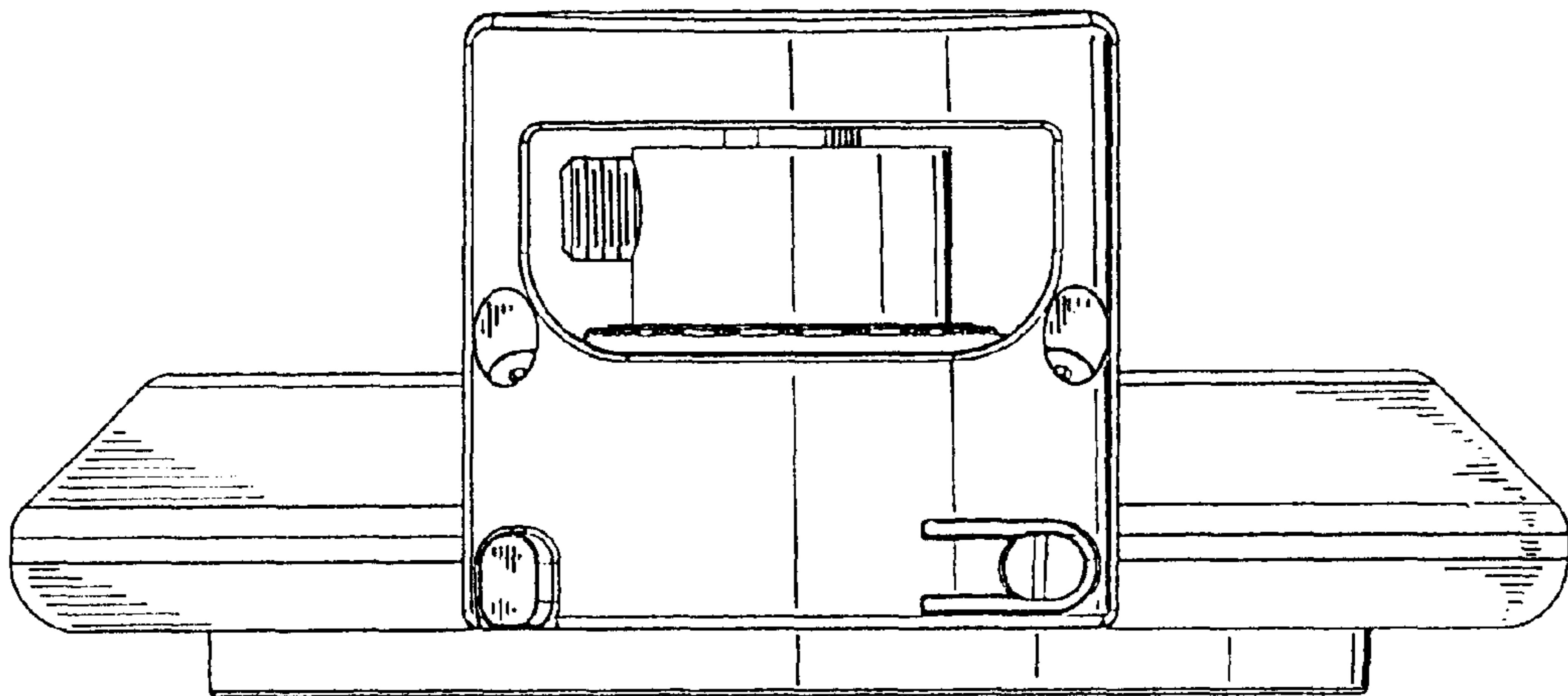

FIG. -30

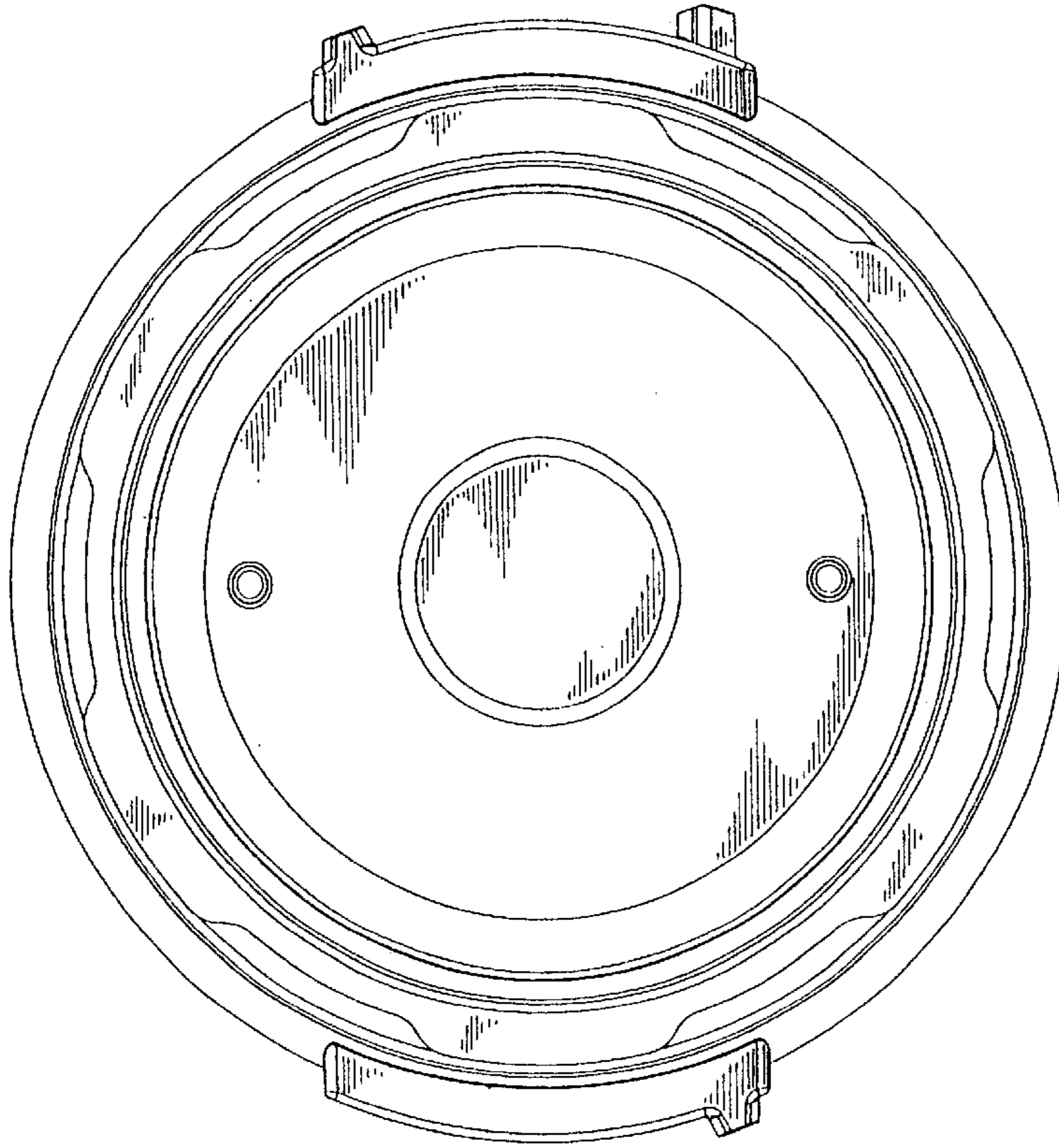

FIG. - 32

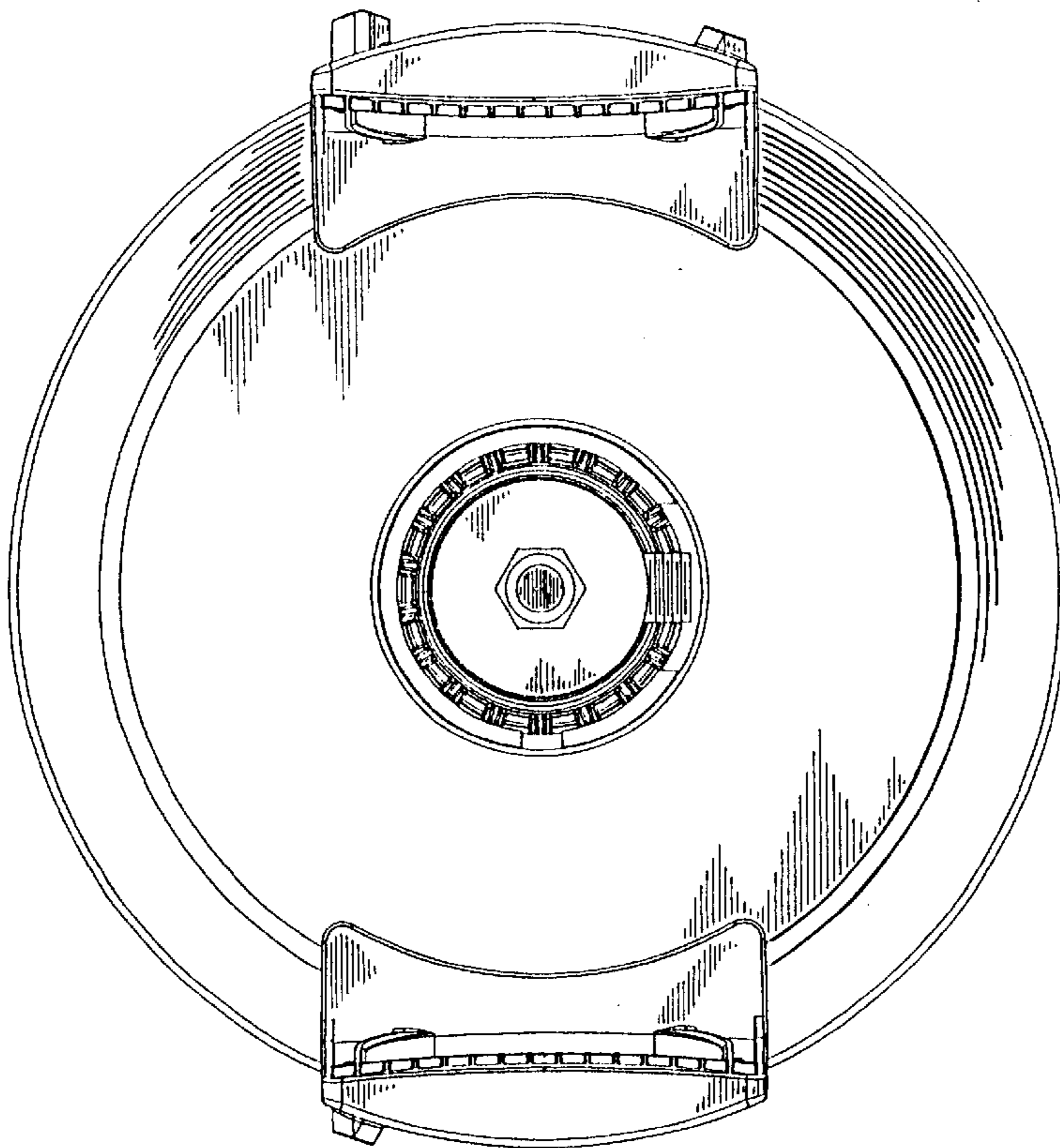

FIG. - 31