



US00D487896S

(12) **United States Design Patent**
Tanner, Jr.

(10) **Patent No.:** **US D487,896 S**

(45) **Date of Patent:** **** Mar. 30, 2004**

(54) **FINGER TIP STYLUS FOR SMALL
KEYBOARD AND TOUCH-SCREEN DATA
INPUT**

2002/0140668 A1 * 10/2002 Crawford 345/156
2003/0011568 A1 * 1/2003 Yoon et al. 345/158
2003/0137489 A1 * 7/2003 Bajramovic 345/158

(76) Inventor: **Orey Tanner, Jr.**, 2620 Cypress Lawn
Dr., Marrero, LA (US) 70072

* cited by examiner

(**) Term: **14 Years**

Primary Examiner—Kay H. Chin

(74) *Attorney, Agent, or Firm*—Donald R. Schoonover

(21) Appl. No.: **29/172,210**

(57) **CLAIM**

(22) Filed: **Dec. 9, 2002**

I claim the ornamental design for a finger tip stylus for small keyboard and touch-screen data input, as shown and described.

(51) **LOC (7) Cl.** **14-02**

(52) **U.S. Cl.** **D14/411; D14/403**

(58) **Field of Search** D14/411, 402,
D14/403, 431; 345/158, 179, 156

DESCRIPTION

(56) **References Cited**

U.S. PATENT DOCUMENTS

4,988,981 A	1/1991	Zimmerman et al.	
5,453,759 A	9/1995	Seebach	
5,889,512 A	3/1999	Moller et al.	
5,973,677 A	10/1999	Gibbons	
D418,494 S	* 1/2000	Robb	D14/411
6,078,803 A	6/2000	Fernandez Martinez	
6,097,369 A	* 8/2000	Wambach	345/158
6,128,004 A	* 10/2000	McDowall et al.	345/158
6,262,684 B1	7/2001	Stewart et al.	
2002/0101401 A1	* 8/2002	Movahed	345/156

FIG. 1 is a perspective view of a finger tip stylus for small keyboard and touch-screen data input showing my new design;
FIG. 2 is a right side elevational view thereof, the left side elevational view being a mirror image thereof;
FIG. 3 is a front elevational view thereof;
FIG. 4 is a rear elevational view thereof;
FIG. 5 is a top plan view thereof;
FIG. 6 is a bottom plan view thereof; and,
FIG. 7 is a reduced perspective view showing the finger tip stylus for small keyboard and touch-screen data input in use; the broken lines show environmental structure for illustrative purposes only and form no part of the claimed design.

1 Claim, 2 Drawing Sheets

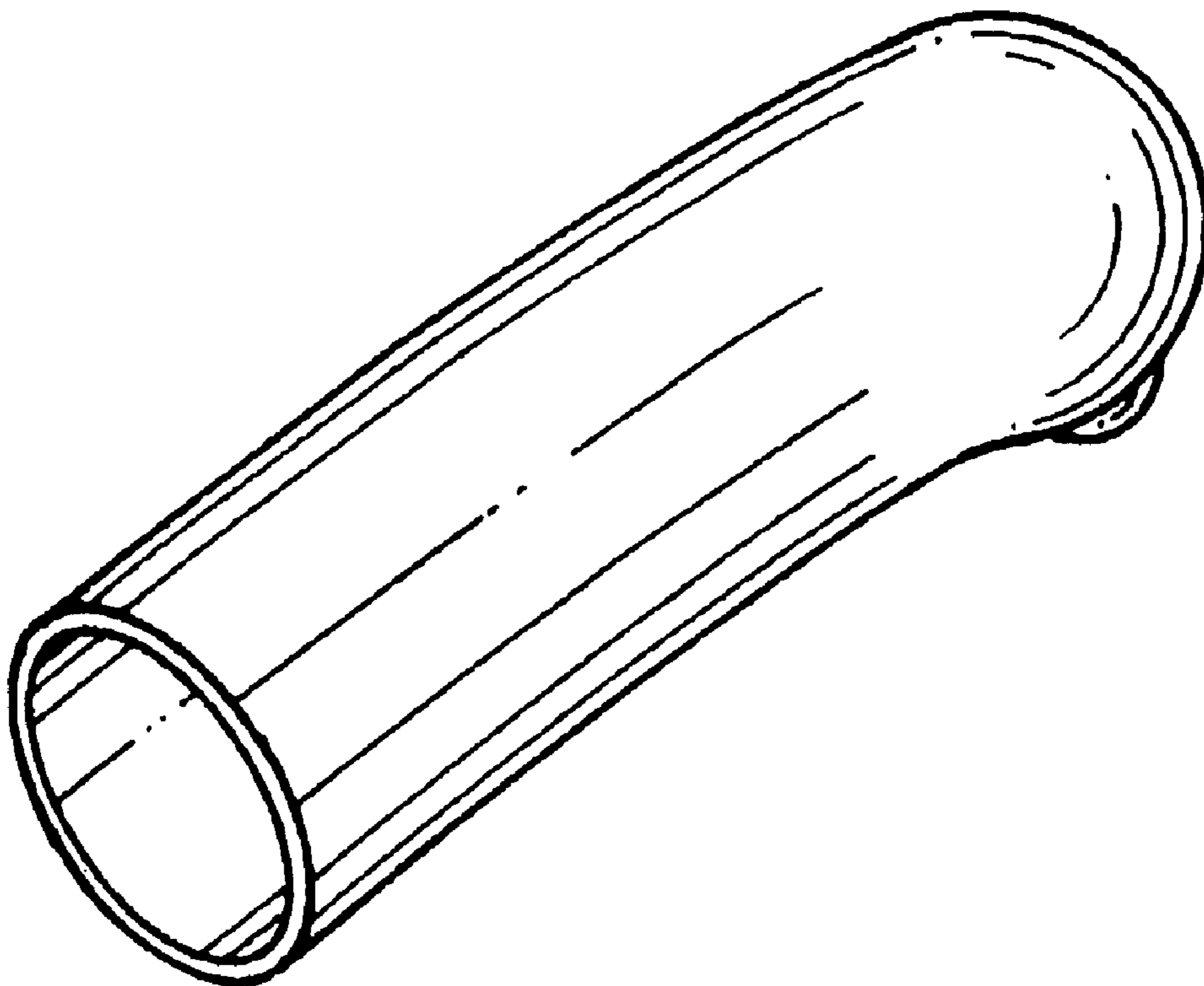

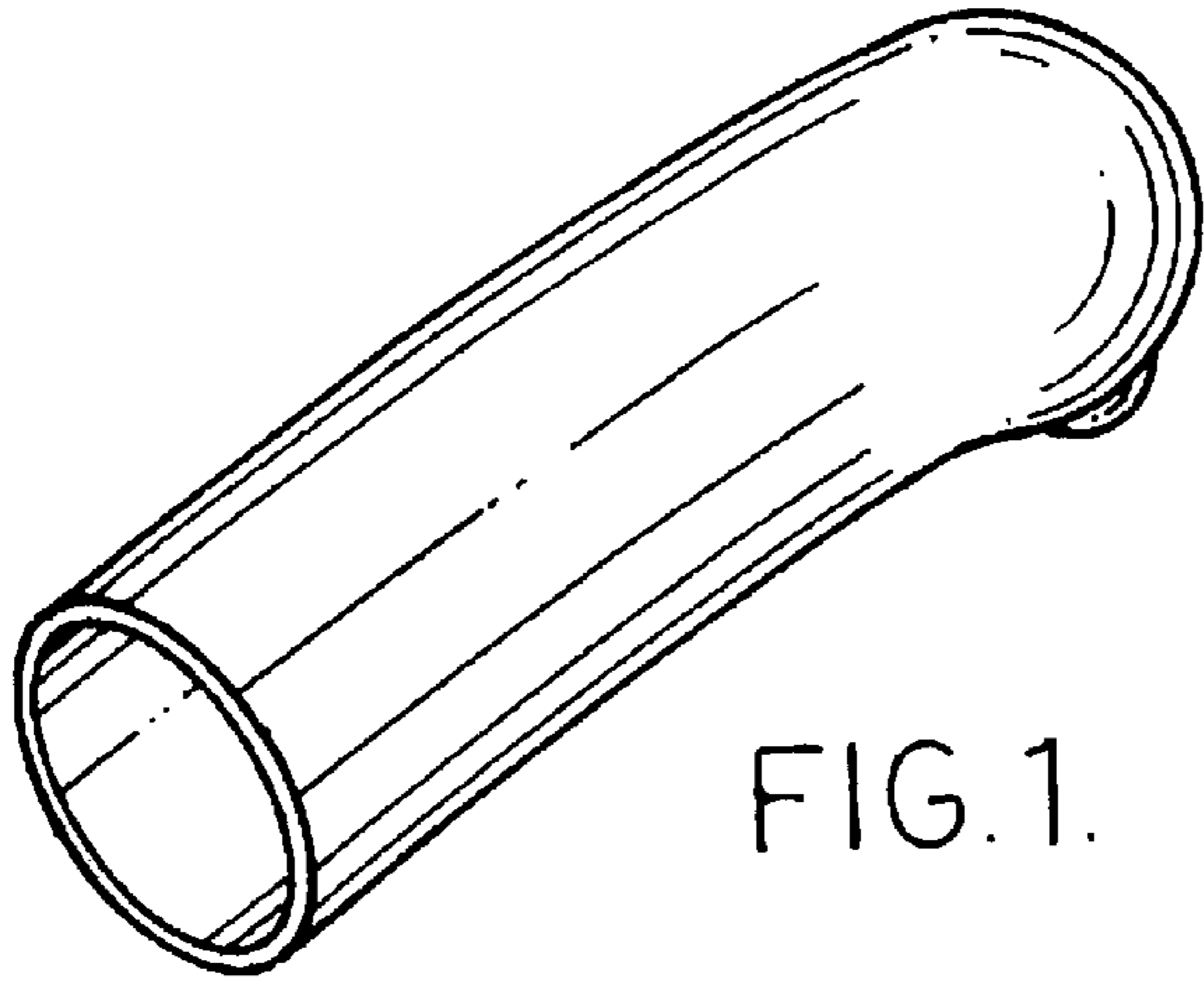

FIG. 1.

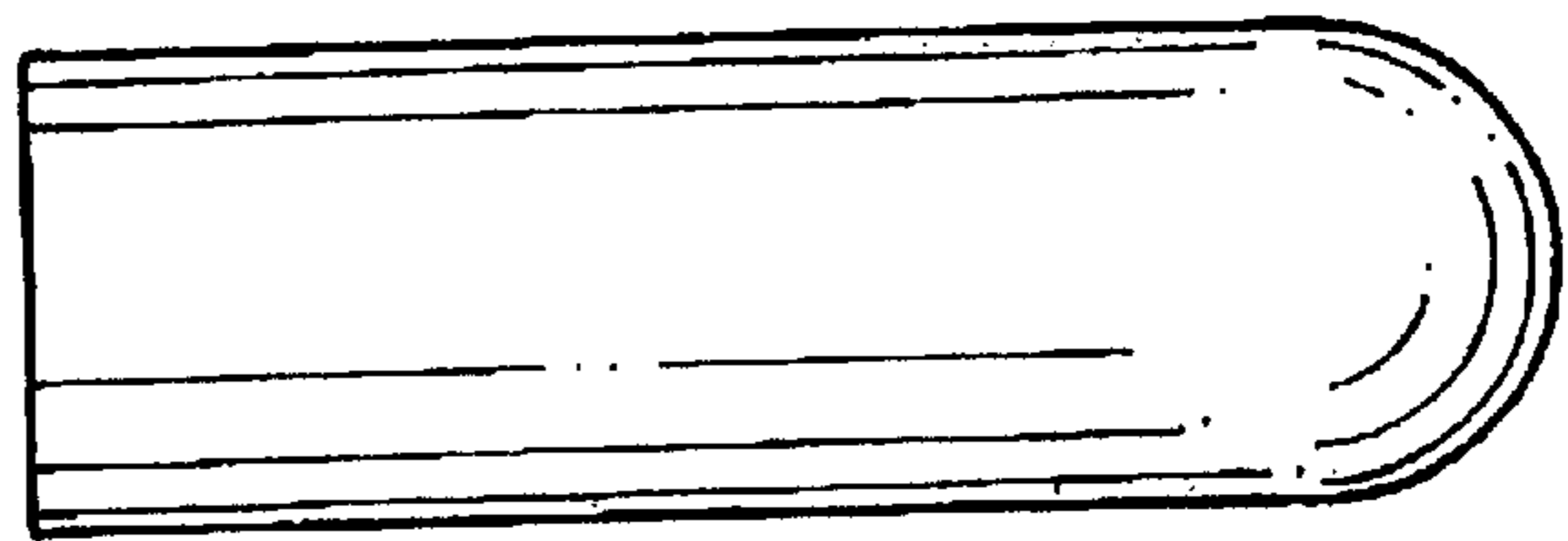

FIG. 5.

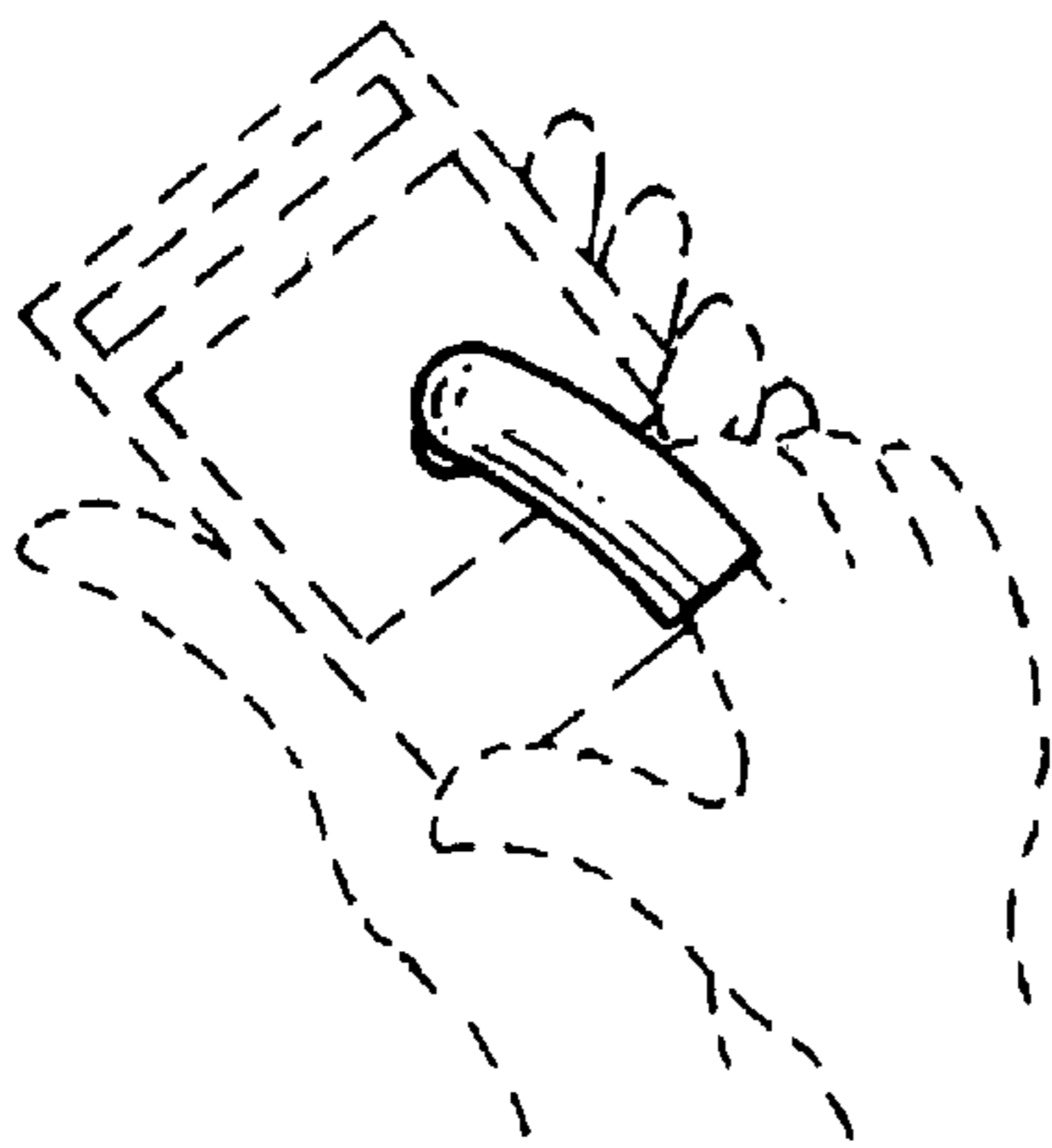

FIG. 7.

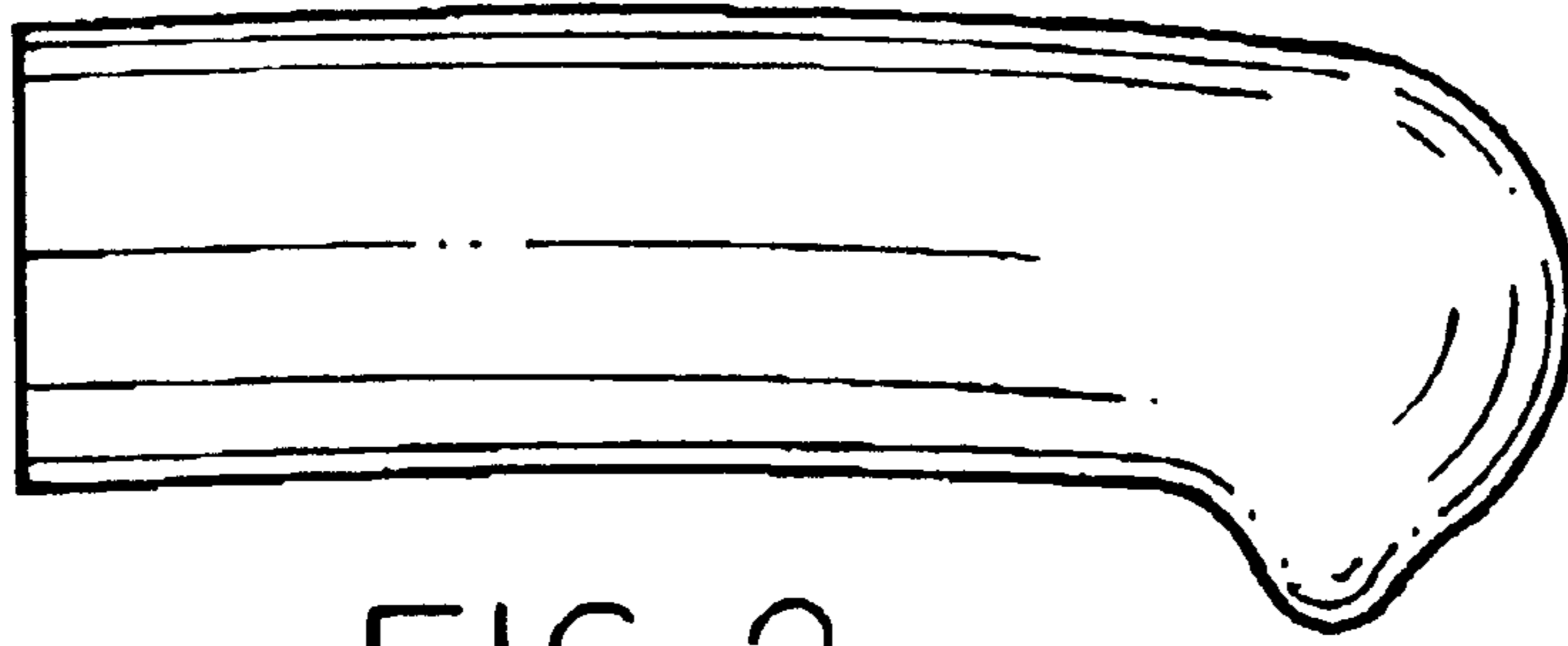

FIG. 2.

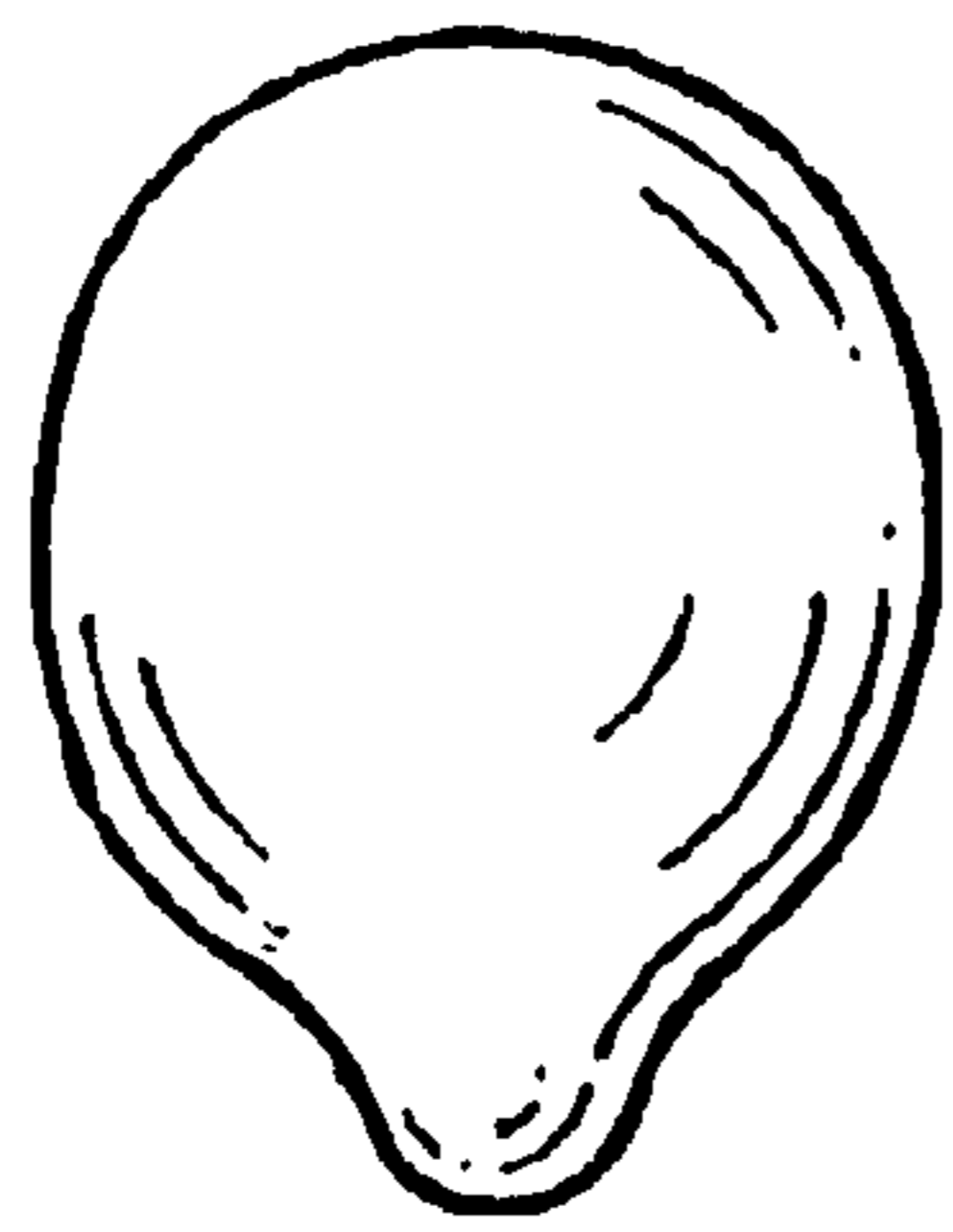

FIG. 3.

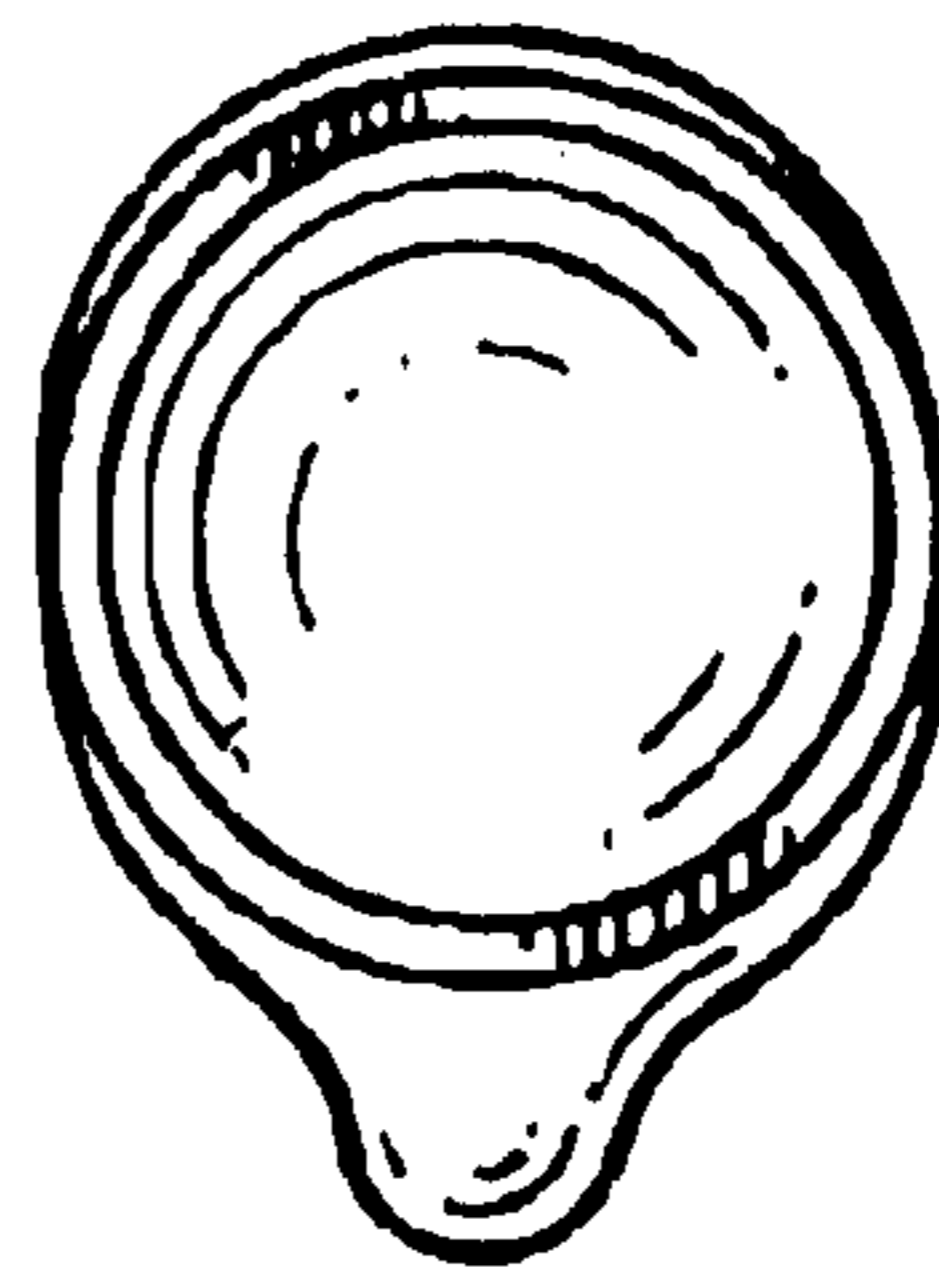

FIG. 4.

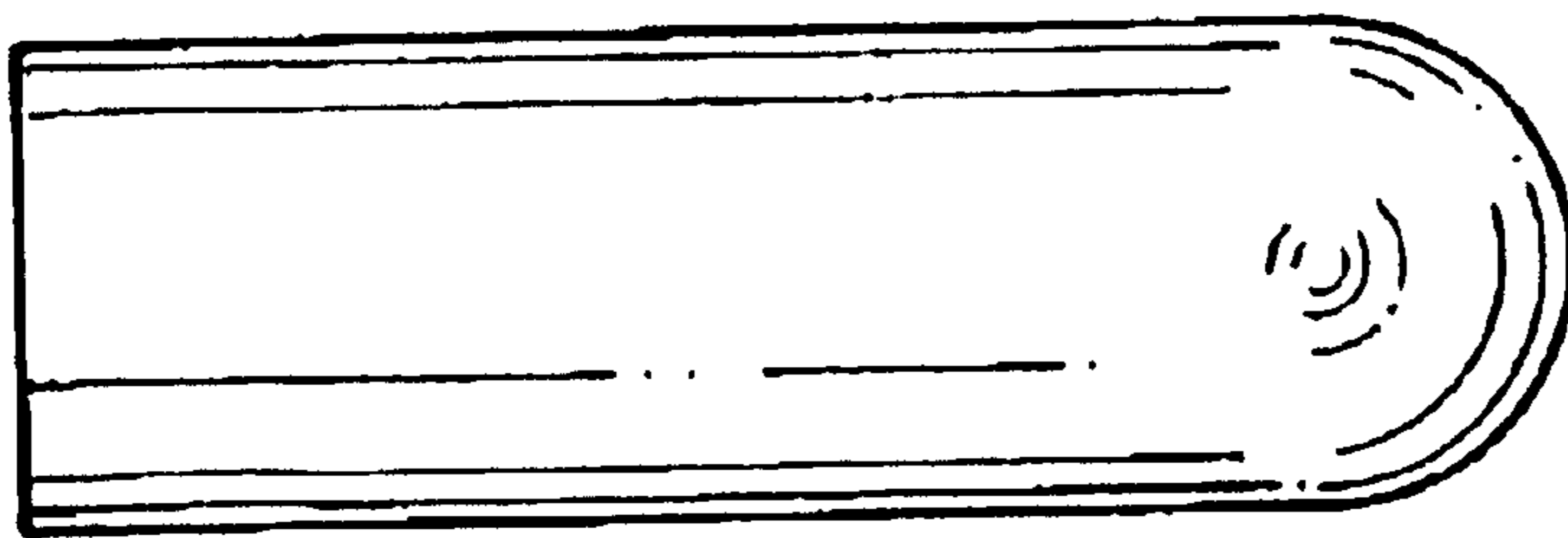

FIG. 6.