



US00D487873S

(12) **United States Design Patent**
Desouza

(10) **Patent No.:** **US D487,873 S**

(45) **Date of Patent:** **** Mar. 30, 2004**

(54) **BOTTLE**

(75) **Inventor:** **Eric Desouza, Concord (CA)**

(73) **Assignee:** **S. C. Johnson & Son, Inc., Racine, WI (US)**

(**) **Term:** **14 Years**

(21) **Appl. No.:** **29/167,503**

(22) **Filed:** **Sep. 17, 2002**

(51) **LOC (7) Cl.** **09-01**

(52) **U.S. Cl.** **D9/522; D9/530; D9/520; D9/564; D9/575; D9/526**

(58) **Field of Search** **D9/516, 522, 523, D9/526, 527, 528, 530, 543, 551, 557, 564, 570, 575; 215/382-384, 396, 398, 400, 11.1-11.6**

(56) **References Cited**

U.S. PATENT DOCUMENTS

357,439	A	*	2/1887	Wheelock	215/11.5
D158,800	S	*	5/1950	Robb	D9/526
D166,454	S	*	4/1952	Cardoso	D9/523
4,087,028	A	*	5/1978	Lang	222/556
D258,046	S	*	1/1981	Richmond	D9/529
D280,601	S	*	9/1985	Biesecker	D9/522
D304,550	S	*	11/1989	Demarest	D9/529
D308,481	S	*	6/1990	Thompson	D9/526
D326,610	S	*	6/1992	Kritzler	D9/526

D327,010	S	*	6/1992	Spiegel	D9/528
D336,607	S	*	6/1993	Nye	D9/300
D381,270	S	*	7/1997	Ballarin et al.	D9/526
D392,568	S	*	3/1998	Goettner	D9/526
D402,561	S	*	12/1998	Utrup et al.	D9/526
D413,805	S		9/1999	Phillips		
D414,115	S	*	9/1999	Goettner et al.	D9/526
D427,078	S		6/2000	Schaaf et al.		
D443,825	S	*	6/2001	Goettner	D9/530
D448,998	S		10/2001	Farris		

* cited by examiner

Primary Examiner—Ted Shooman
Assistant Examiner—Carol Rademaker

(57) **CLAIM**

I claim the ornamental design for a bottle, as shown and described.

DESCRIPTION

FIG. 1 is a perspective view of a bottle from the front, top and left side thereof showing my new design;
FIG. 2 is a perspective view of the bottle from the rear, bottom, and right side thereof;
FIG. 3 is a left side view thereof;
FIG. 4 is a right side view thereof;
FIG. 5 is a front view thereof;
FIG. 6 is a rear view thereof;
FIG. 7 is a top view thereof; and,
FIG. 8 is a bottom view thereof.

1 Claim, 3 Drawing Sheets

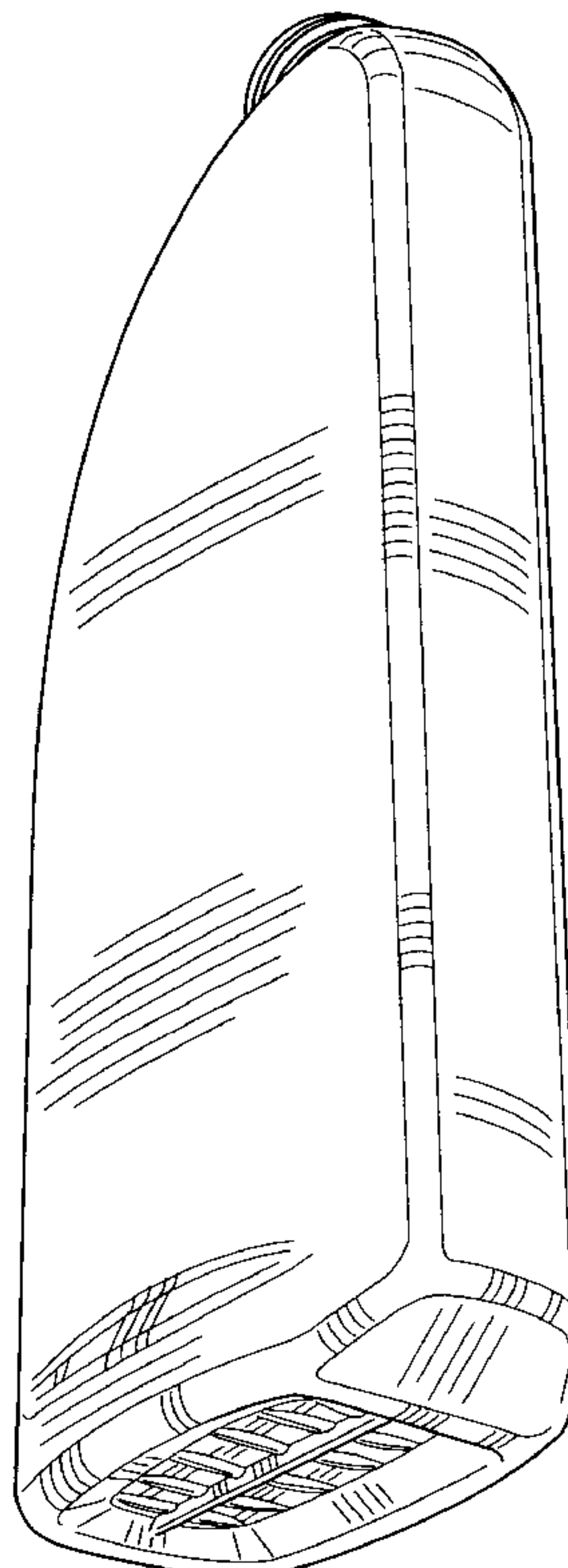
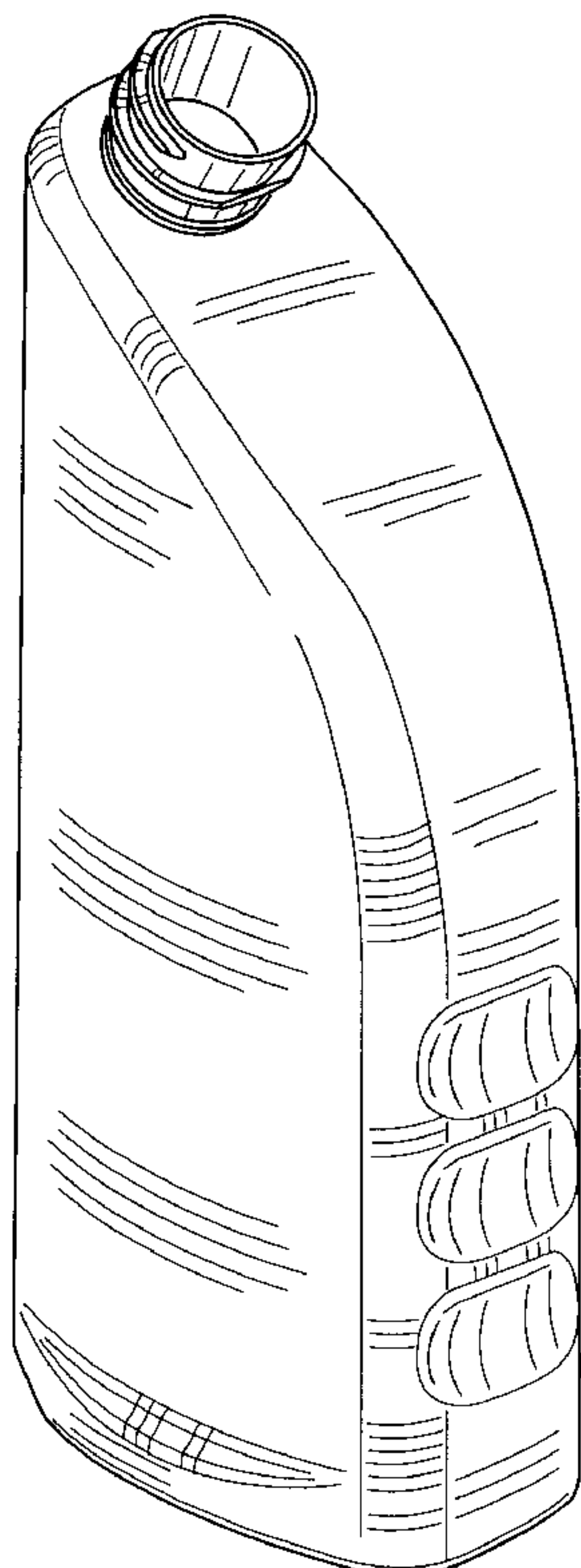

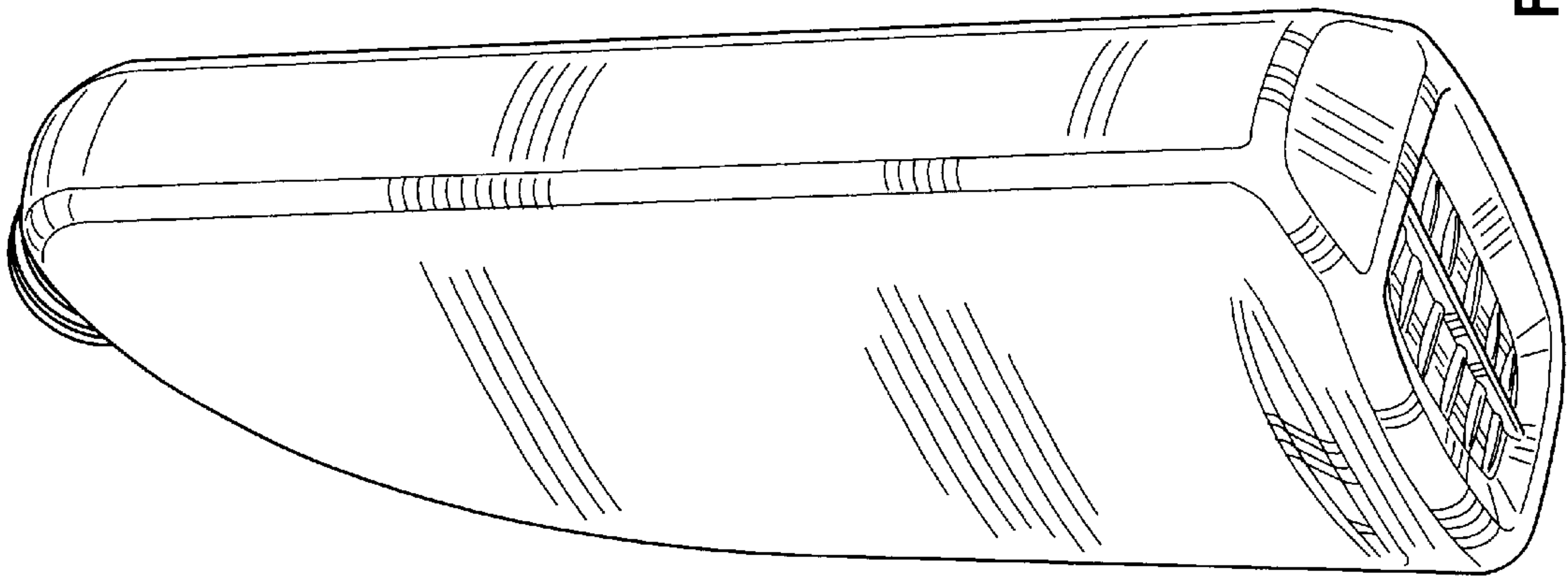

FIG. 2

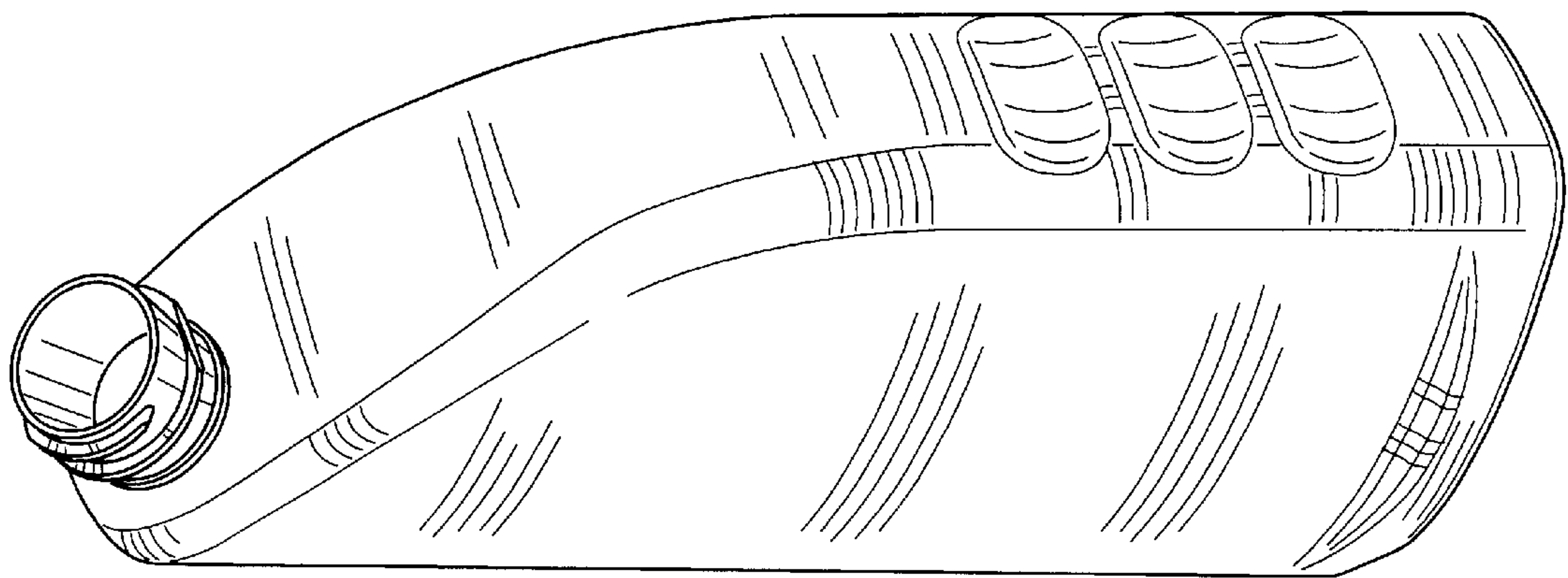

FIG. 1

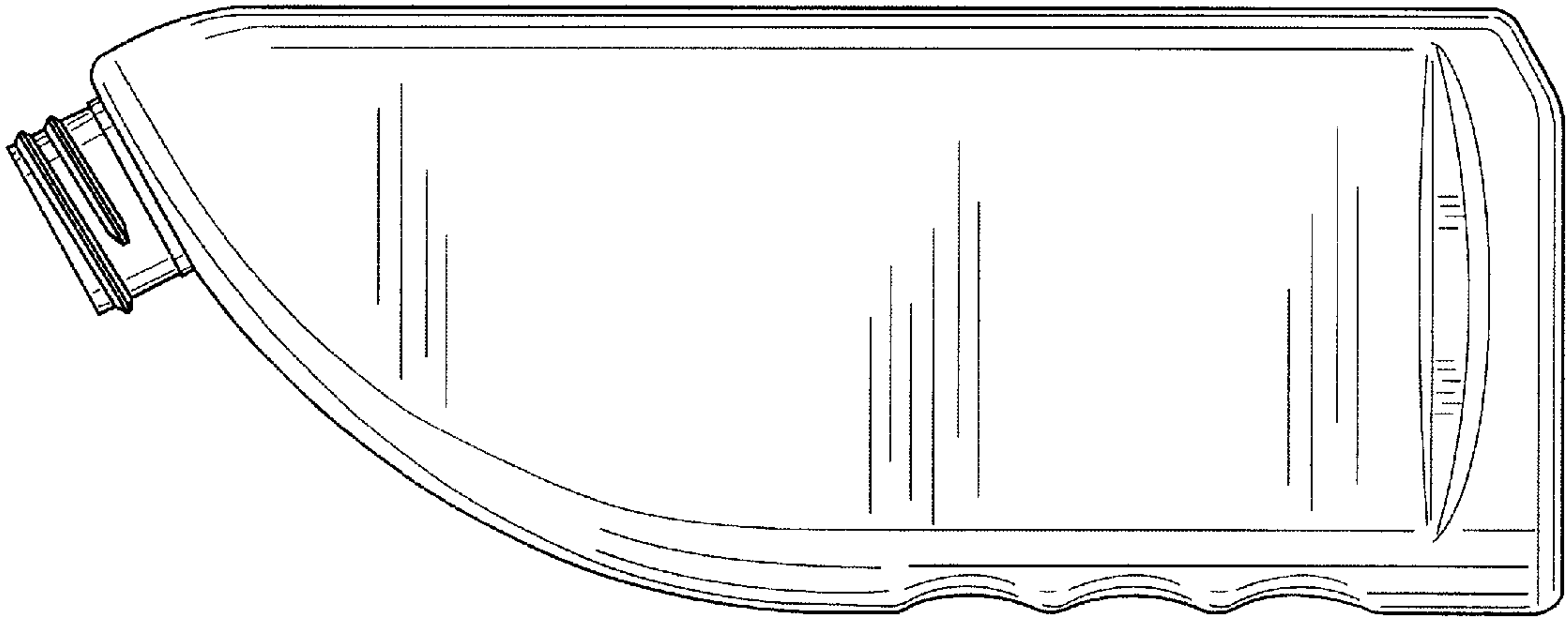

FIG. 4

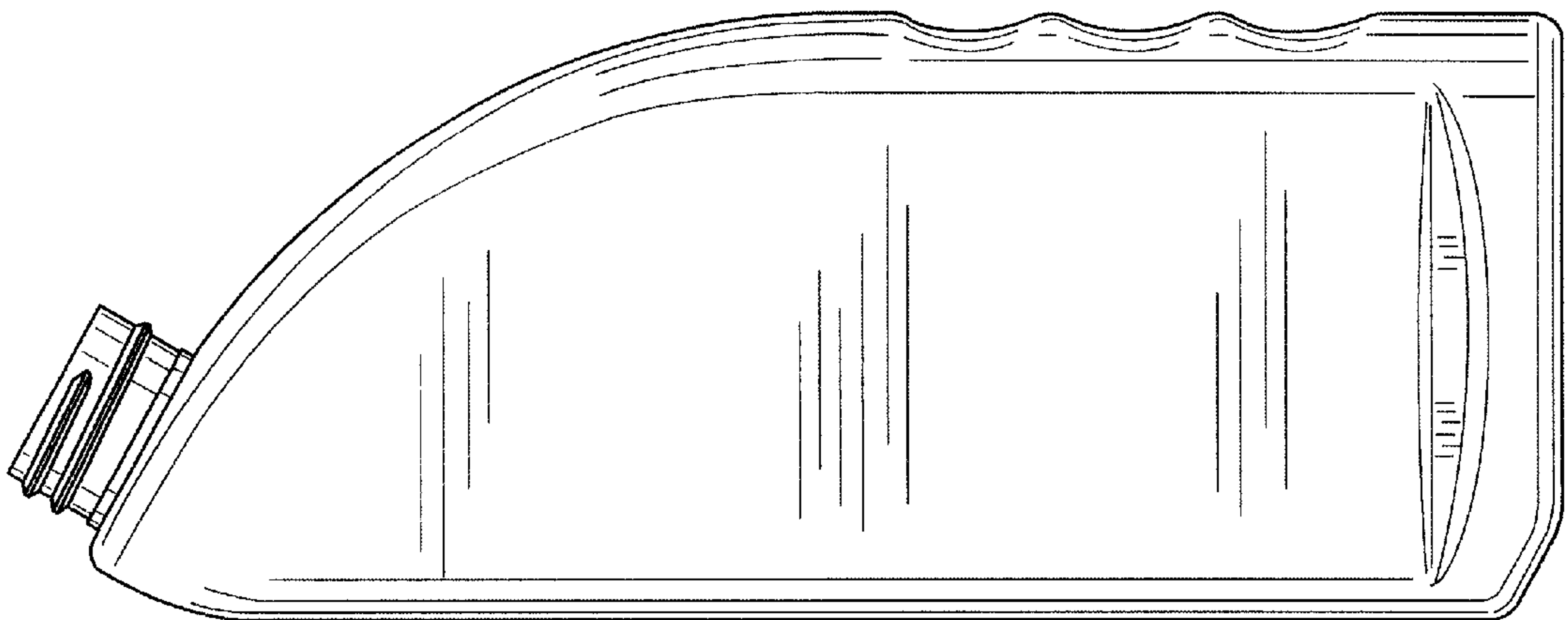

FIG. 3

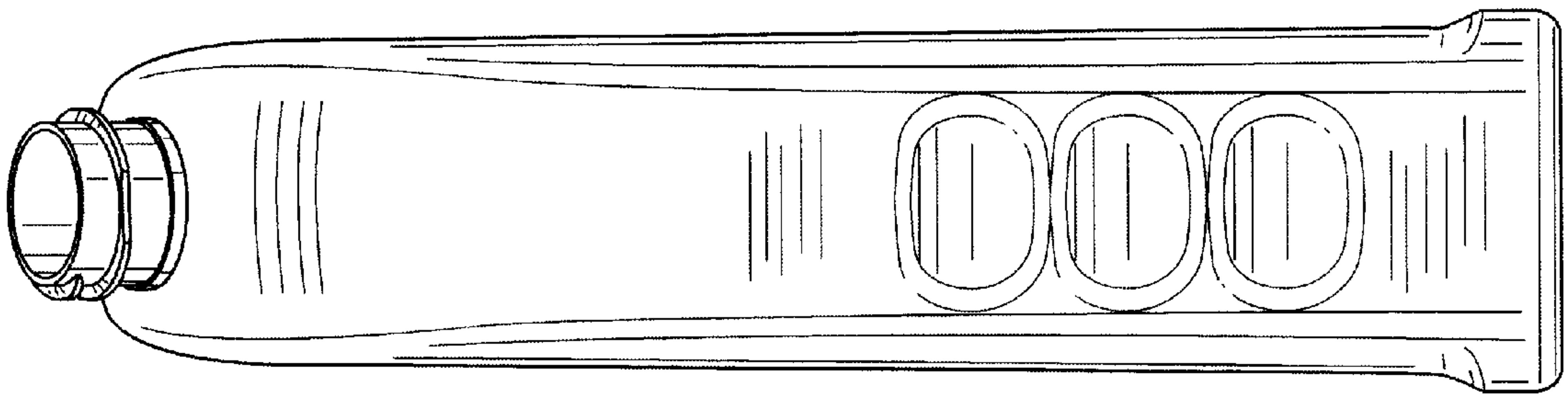

FIG. 5

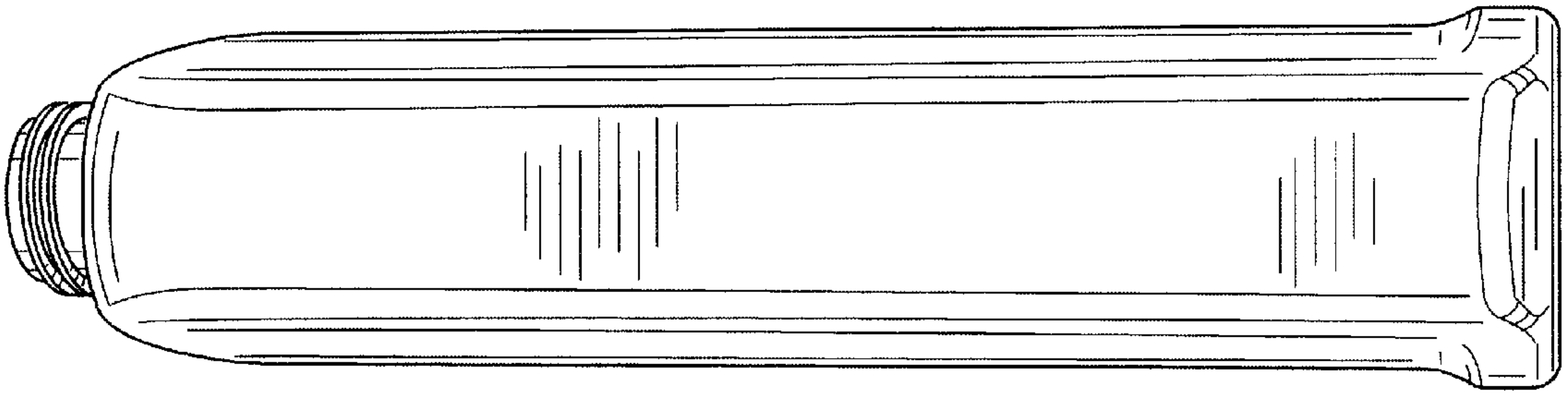

FIG. 6

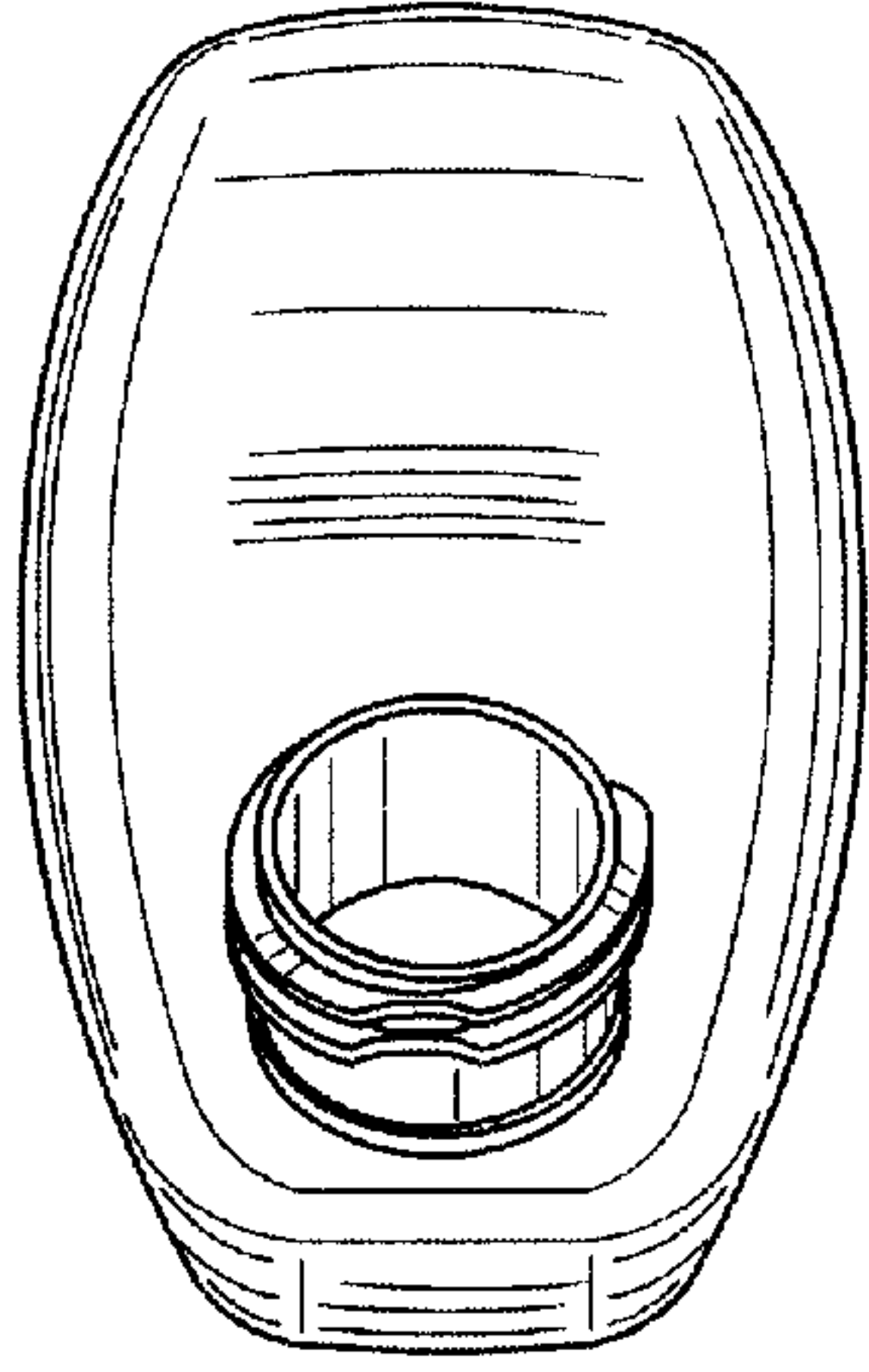

FIG. 7

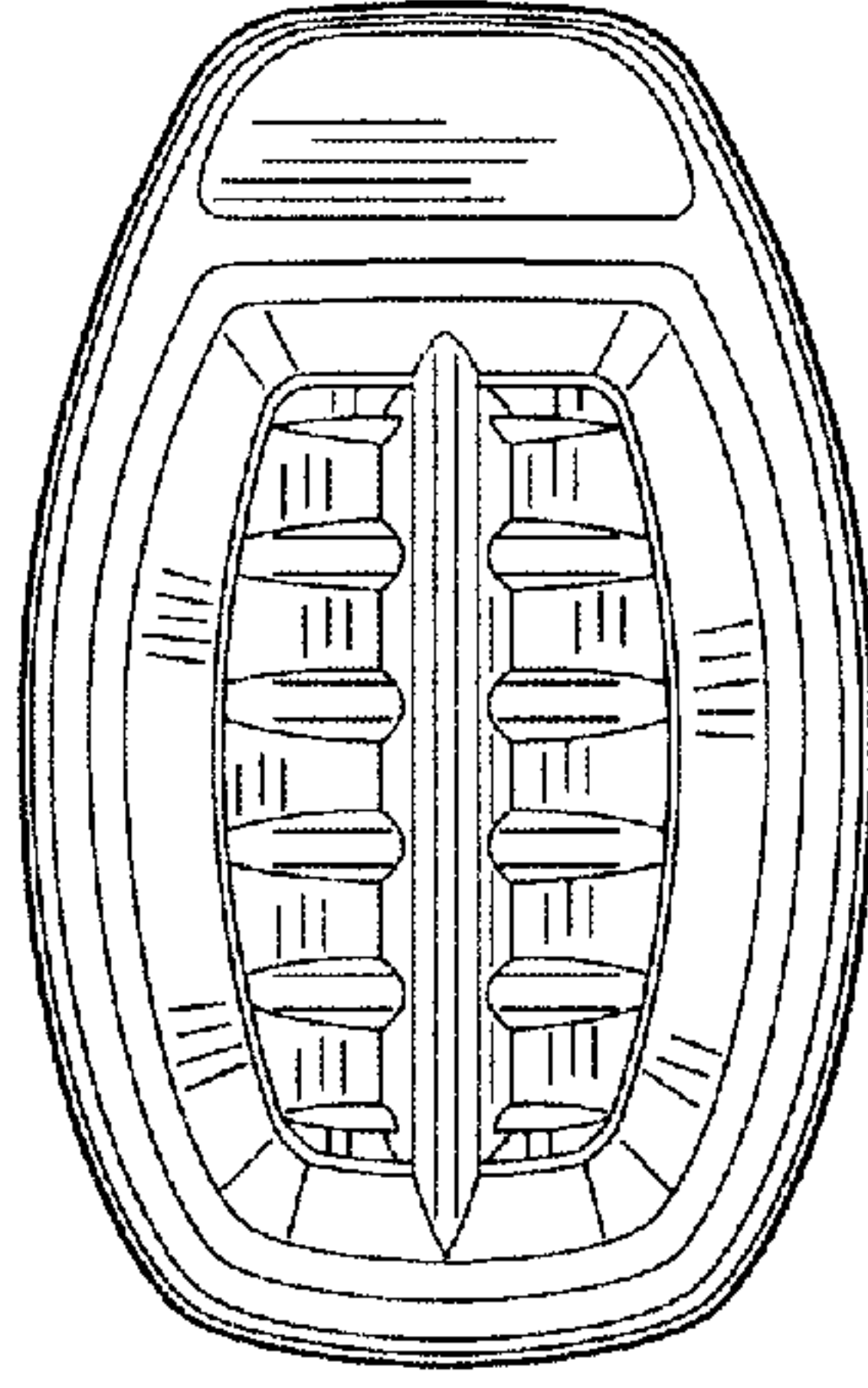

FIG. 8