



US00D487815S

(12) **United States Design Patent**
Hoernig

(10) **Patent No.:** **US D487,815 S**

(45) **Date of Patent:** **** Mar. 23, 2004**

(54) **WALL LIGHT**

(75) **Inventor:** **Victor Hoernig**, Lowell, IN (US)

(73) **Assignee:** **Bath Unlimited, Inc.**, Fort Mill, SC (US)

(**) **Term:** **14 Years**

(21) **Appl. No.:** **29/183,979**

(22) **Filed:** **Jun. 19, 2003**

(51) **LOC (7) Cl.** **26-03**

(52) **U.S. Cl.** **D26/87; D26/92**

(58) **Field of Search** D26/24, 67-73,
D26/80, 82, 84-92, 128; 362/145, 147,
153, 153.1, 186, 257, 276, 312, 330, 351,
354, 358, 361-363, 431-433, 806

(56) **References Cited**

U.S. PATENT DOCUMENTS

D164,507 S	*	9/1951	McCann	D26/76
D185,974 S	*	8/1959	Rambusch et al.	D26/85
4,258,413 A	*	3/1981	Mausser	362/287
D403,097 S	*	12/1998	Littman	D26/87
D413,998 S	*	9/1999	Littman	D26/87
D441,125 S	*	4/2001	Crosby	D26/87
D441,488 S	*	5/2001	Benghozi	D26/87

D442,317 S	*	5/2001	Crosby	D26/87
D465,298 S	*	11/2002	Gottwald	D26/85
D473,002 S	*	4/2003	Hoernig	D26/87

OTHER PUBLICATIONS

Kichler Catalog No. 793 (c)1993; p. 181; item K-9244WH.*

* cited by examiner

Primary Examiner—Clare E. Heflin

(74) *Attorney, Agent, or Firm*—Edgar A. Zarins; Lloyd D. Doigan

(57) **CLAIM**

The ornamental design for a wall light, as shown and described.

DESCRIPTION

FIG. 1 is a perspective view of a wall light showing my new design;
FIG. 2 is a front elevational view thereof;
FIG. 3 is a top plan view thereof;
FIG. 4 is a right side view thereof, the opposite side being a mirror image of the side shown; and,
FIG. 5 is a bottom plan view thereof.

1 Claim, 1 Drawing Sheet

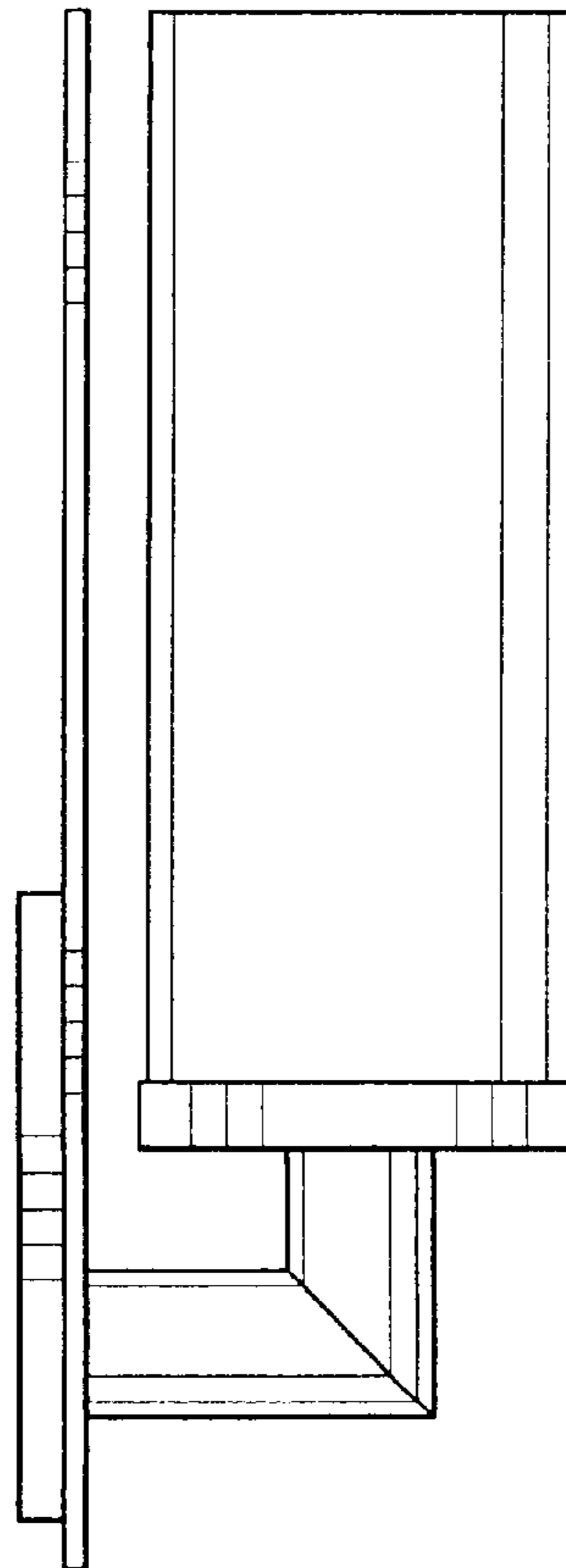
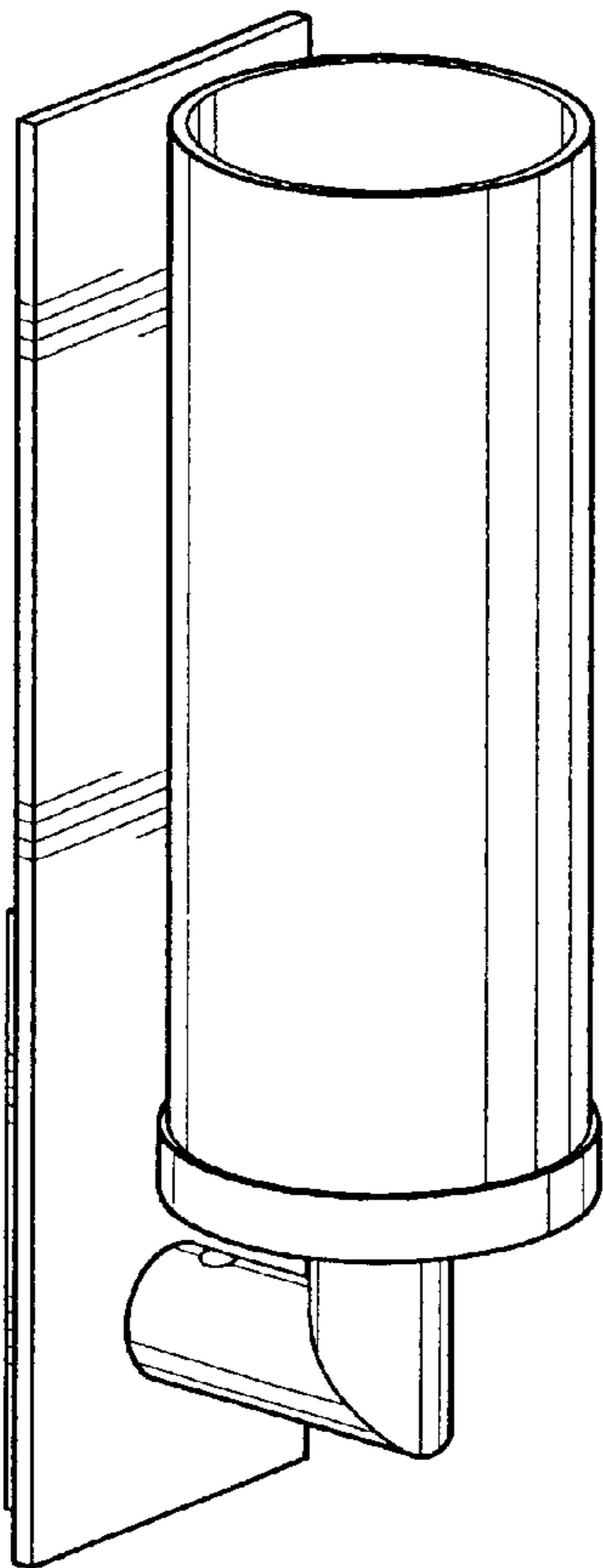

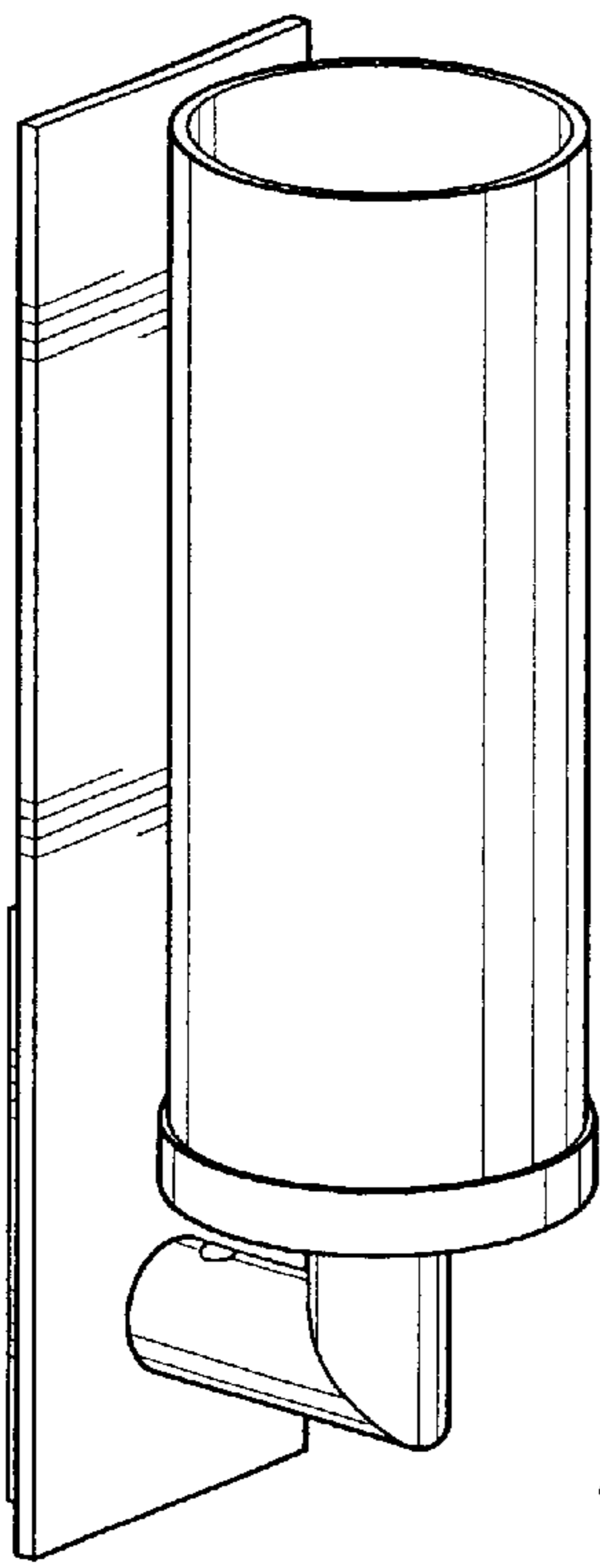

Fig-1

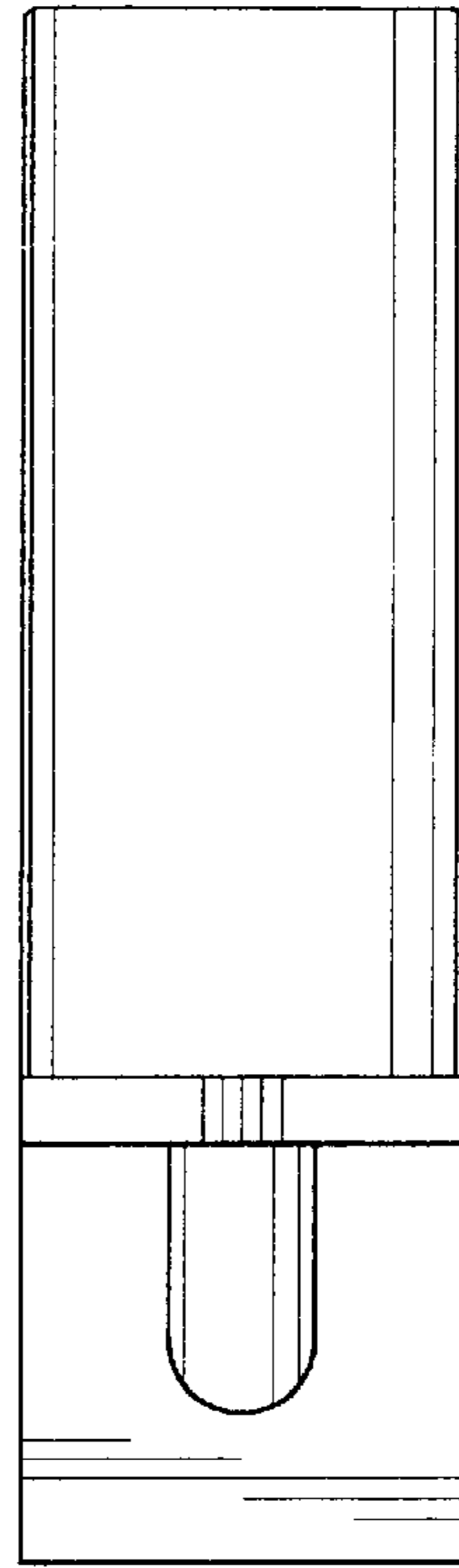

Fig-2

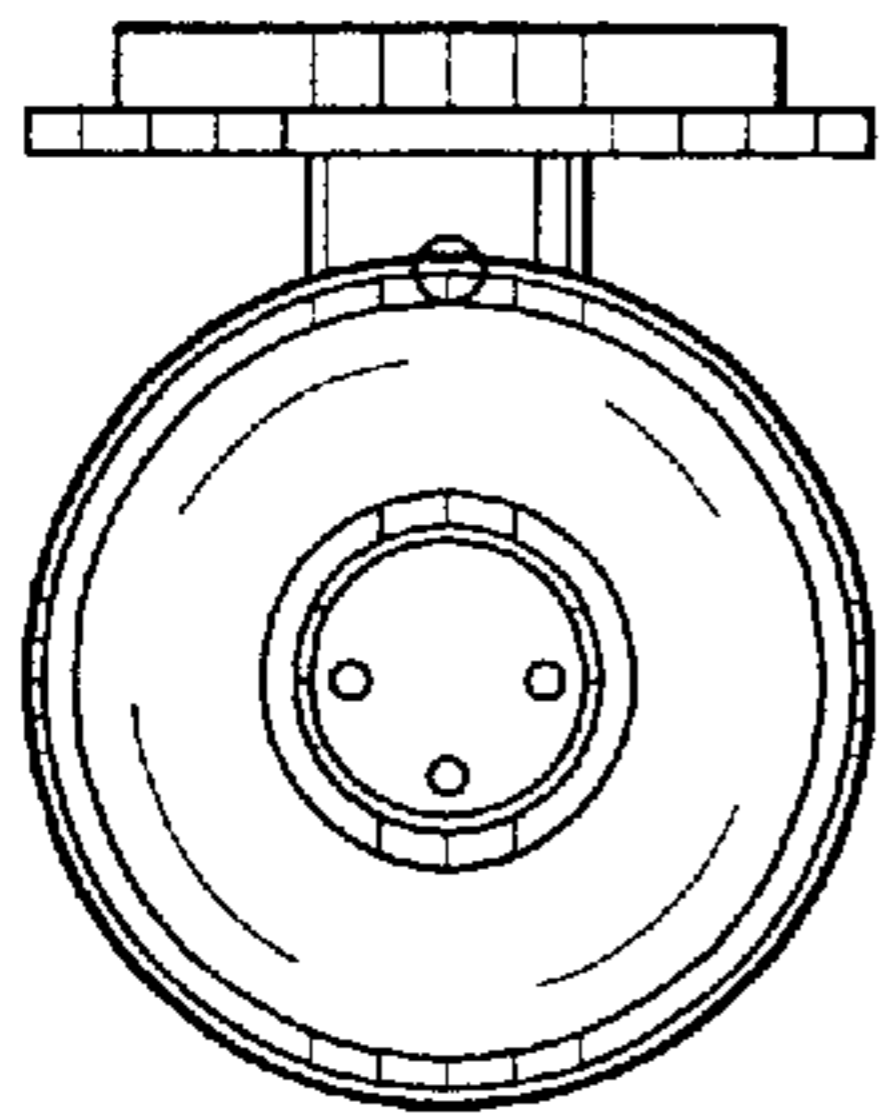

Fig-3

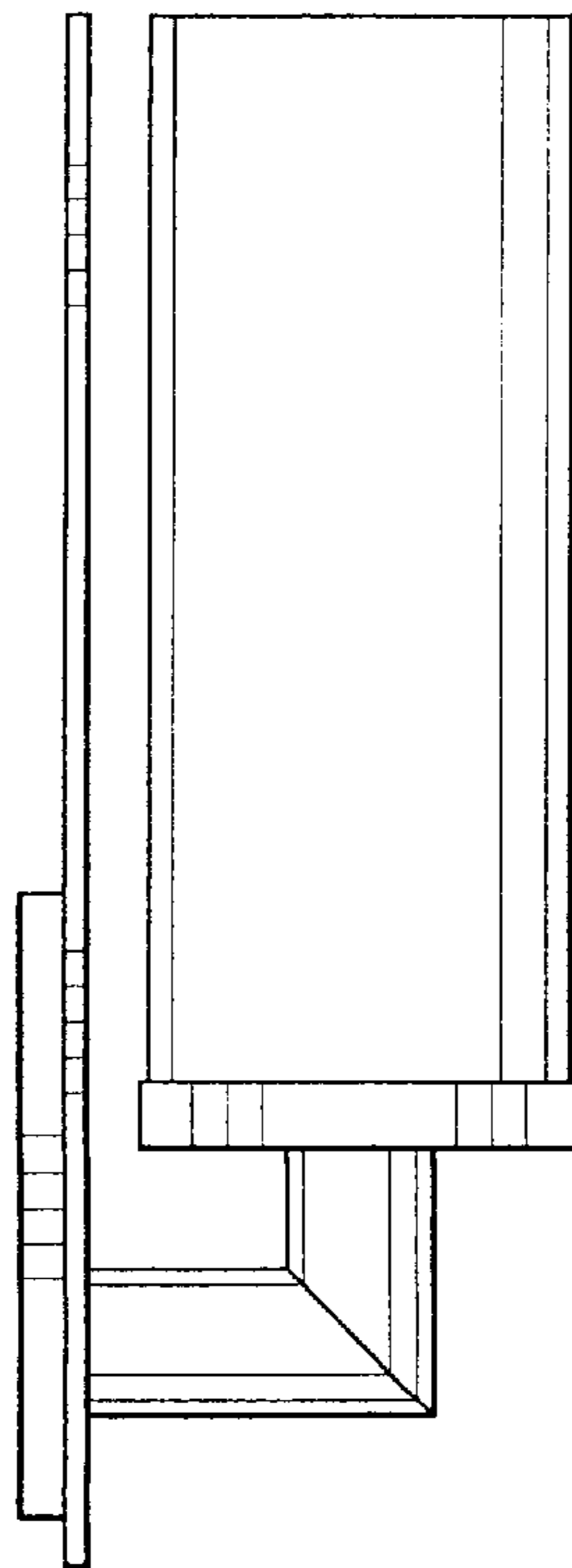

Fig-4

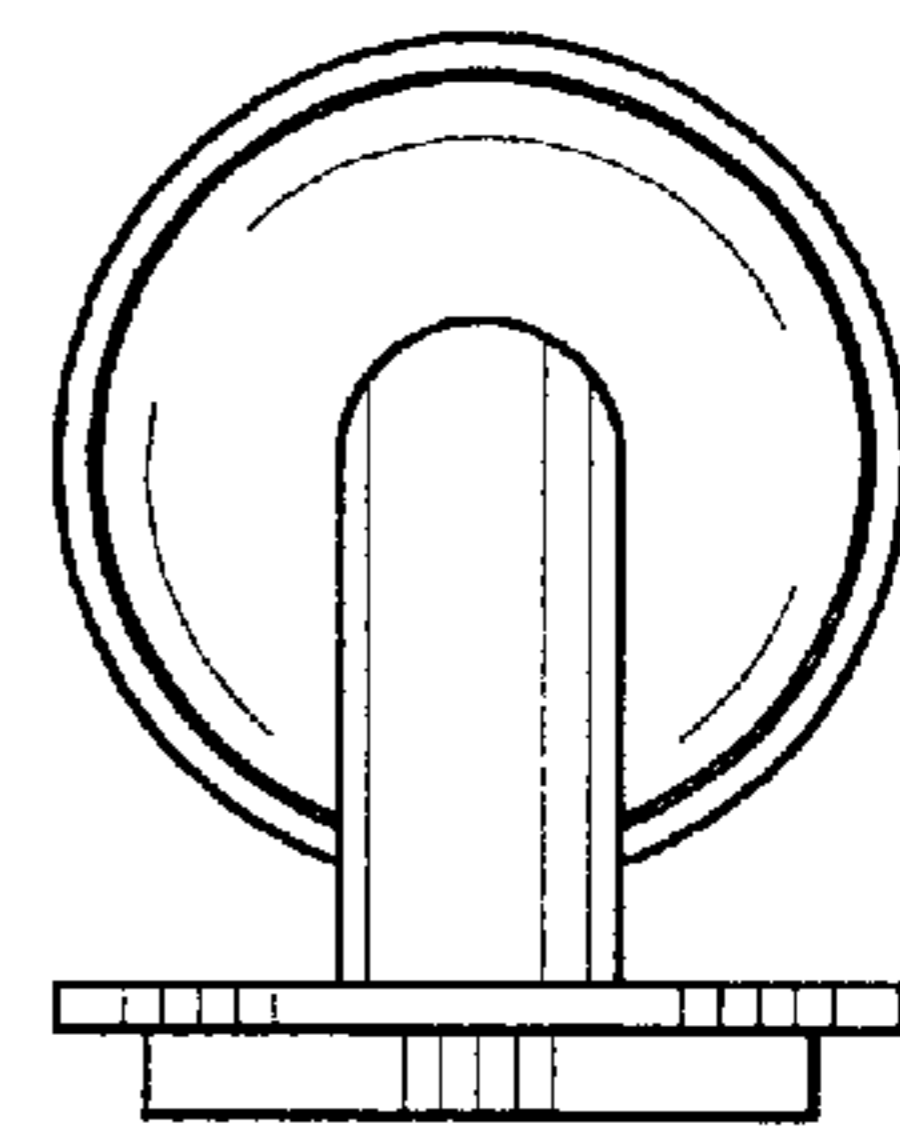

Fig-5