



US00D487756S

(12) **United States Design Patent**
Kasperik et al.

(10) **Patent No.:** **US D487,756 S**
(45) **Date of Patent:** **** Mar. 23, 2004**

(54) **CUTTING INSERT**

(75) Inventors: **James Robert Kasperik**, Latrobe, PA (US); **John P. Brosnahan**, North Huntingdon, PA (US)

(73) Assignee: **Kennametal Inc.**, Latrobe, PA (US)

(**) Term: **14 Years**

(21) Appl. No.: **29/182,480**

(22) Filed: **May 28, 2003**

(51) **LOC (7) Cl.** **15-09**

(52) **U.S. Cl.** **D15/139**

(58) **Field of Search** D15/127, 130, D15/138-39; 407/113-17

(56) **References Cited**

U.S. PATENT DOCUMENTS

4,367,900	A	*	1/1983	Trumper	407/116	X
4,856,942	A	*	8/1989	Bernadic et al.	407/114	
5,180,258	A	*	1/1993	Bernadic	407/114	
D345,984	S	*	4/1994	Ishikawa et al.	D15/139	
D362,859	S	*	10/1995	Wiman et al.	D15/139	
D477,003	S	*	7/2003	Muren et al.	D15/139	

OTHER PUBLICATIONS

Kennametal Lathe Tooling Catalog 1010, Kennametal Inc., 2001, 13 pages (Front & Back Covers, pp. 52, 53, 64, 65, 74, 75, 84, 85, 94, 95, and Back Inside Cover).

* cited by examiner

Primary Examiner—Brian N. Vinson

(74) *Attorney, Agent, or Firm*—Larry R. Meenan

(57) **CLAIM**

The ornamental design for a cutting insert, as shown and described.

DESCRIPTION

FIG. 1 is a front, perspective view of a cutting insert showing our new design;

FIG. 2 is a rear, perspective view of the cutting insert of FIG. 1;

FIG. 3 is a top view of the cutting insert of FIG. 1;

FIG. 4 is a bottom view of the cutting insert of FIG. 1;

FIG. 5 is a left side view of the cutting insert of FIG. 1;

FIG. 6 is a right side view of the cutting insert of FIG. 1;

FIG. 7 is a top view of the cutting insert of FIG. 1; and,

FIG. 8 is a rear view of the cutting insert of FIG. 1.

The broken-line disclosure in the views is for illustrative purposes only and forms no part of the claimed design.

1 Claim, 3 Drawing Sheets

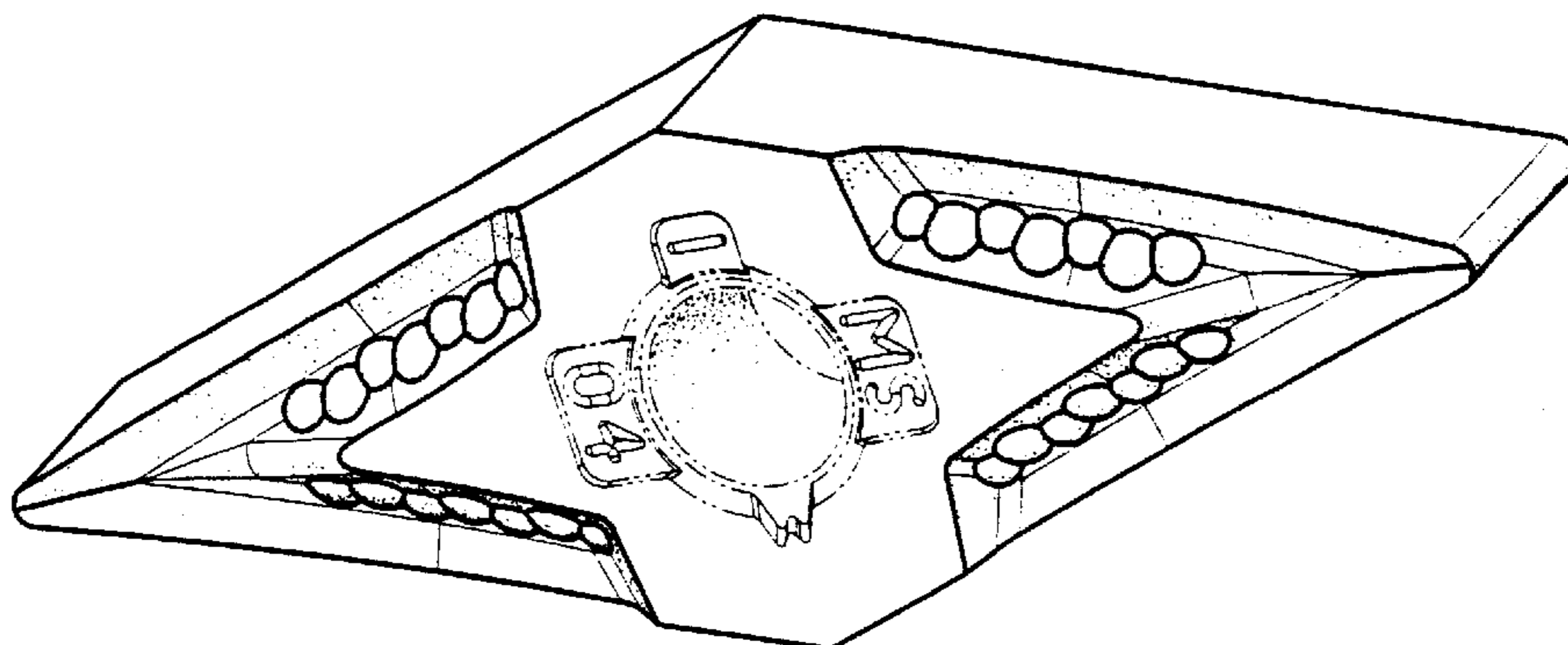

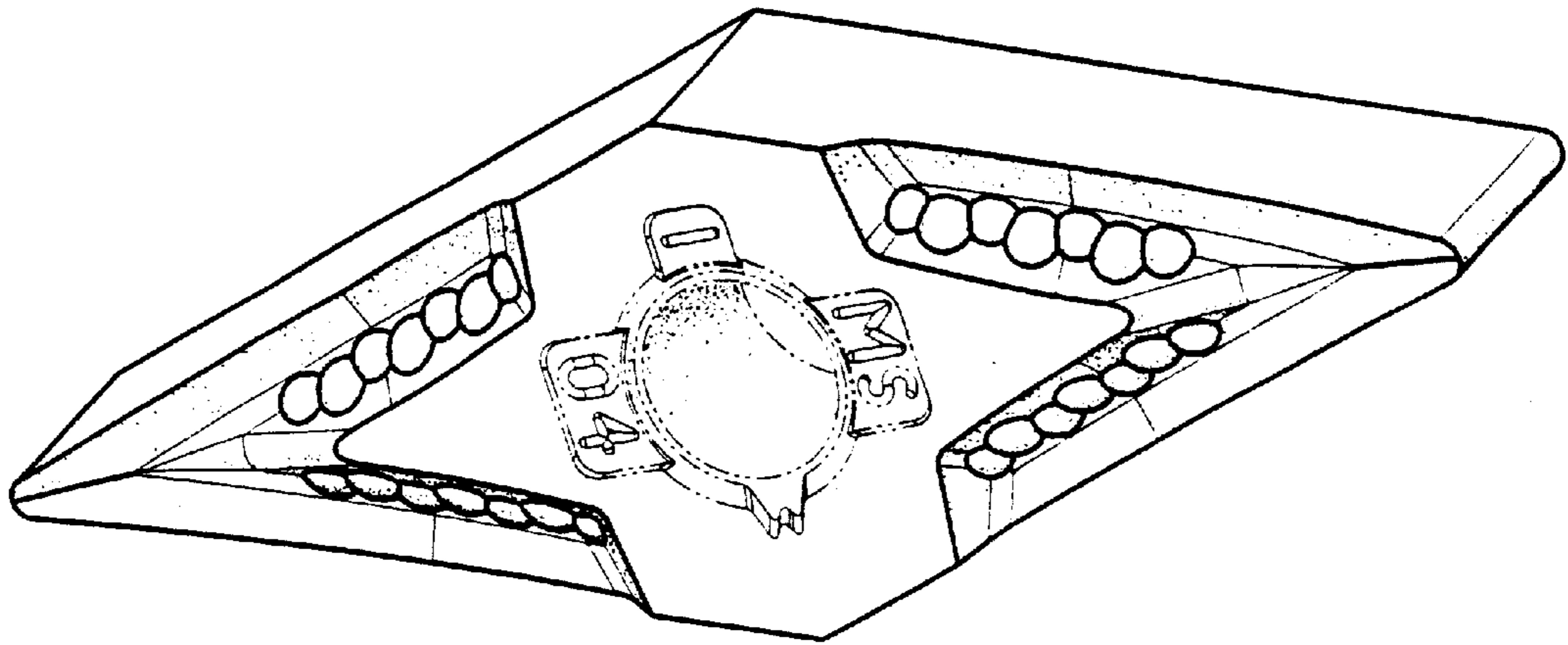

FIG. 1

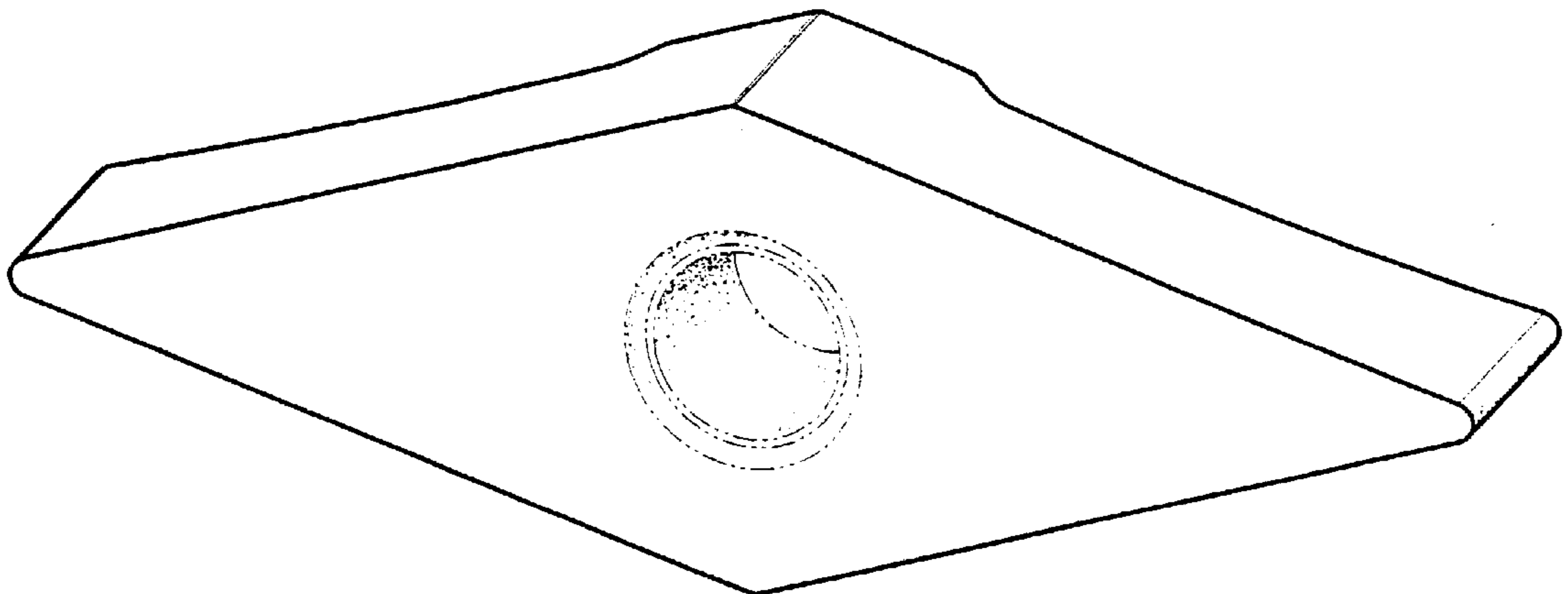

FIG. 2

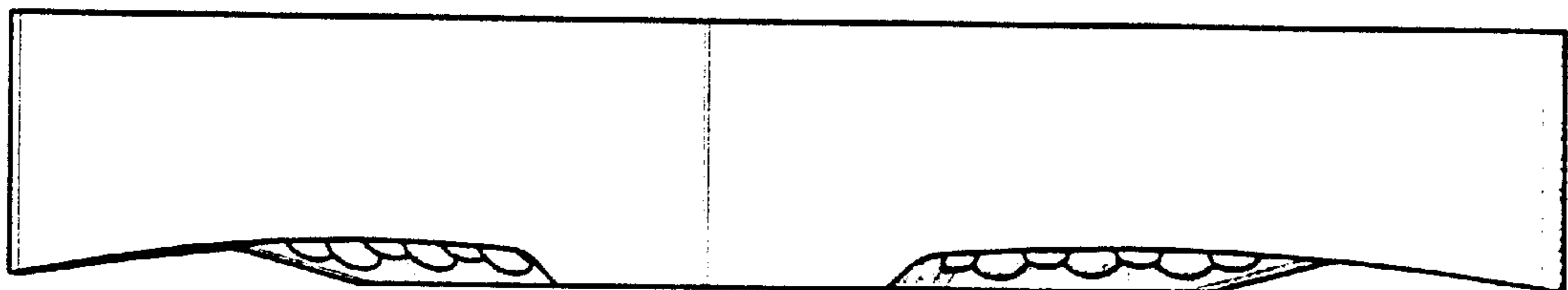

FIG. 3

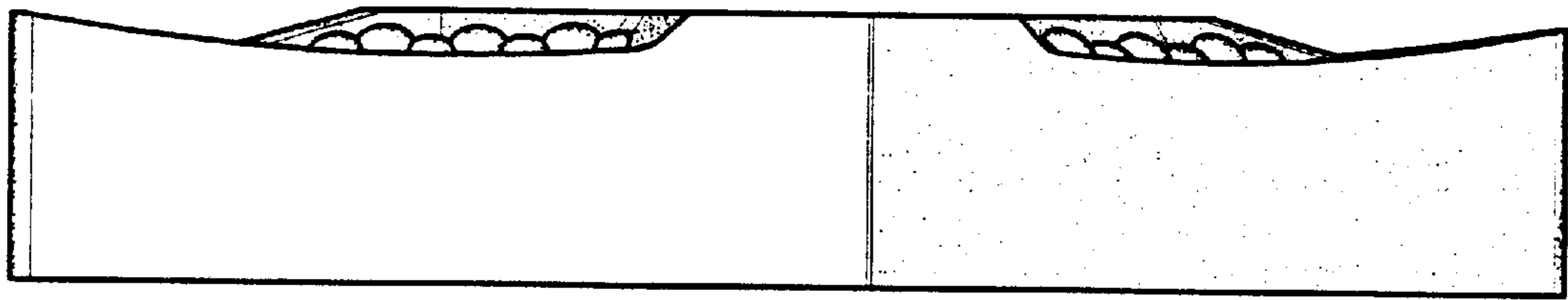

FIG. 4

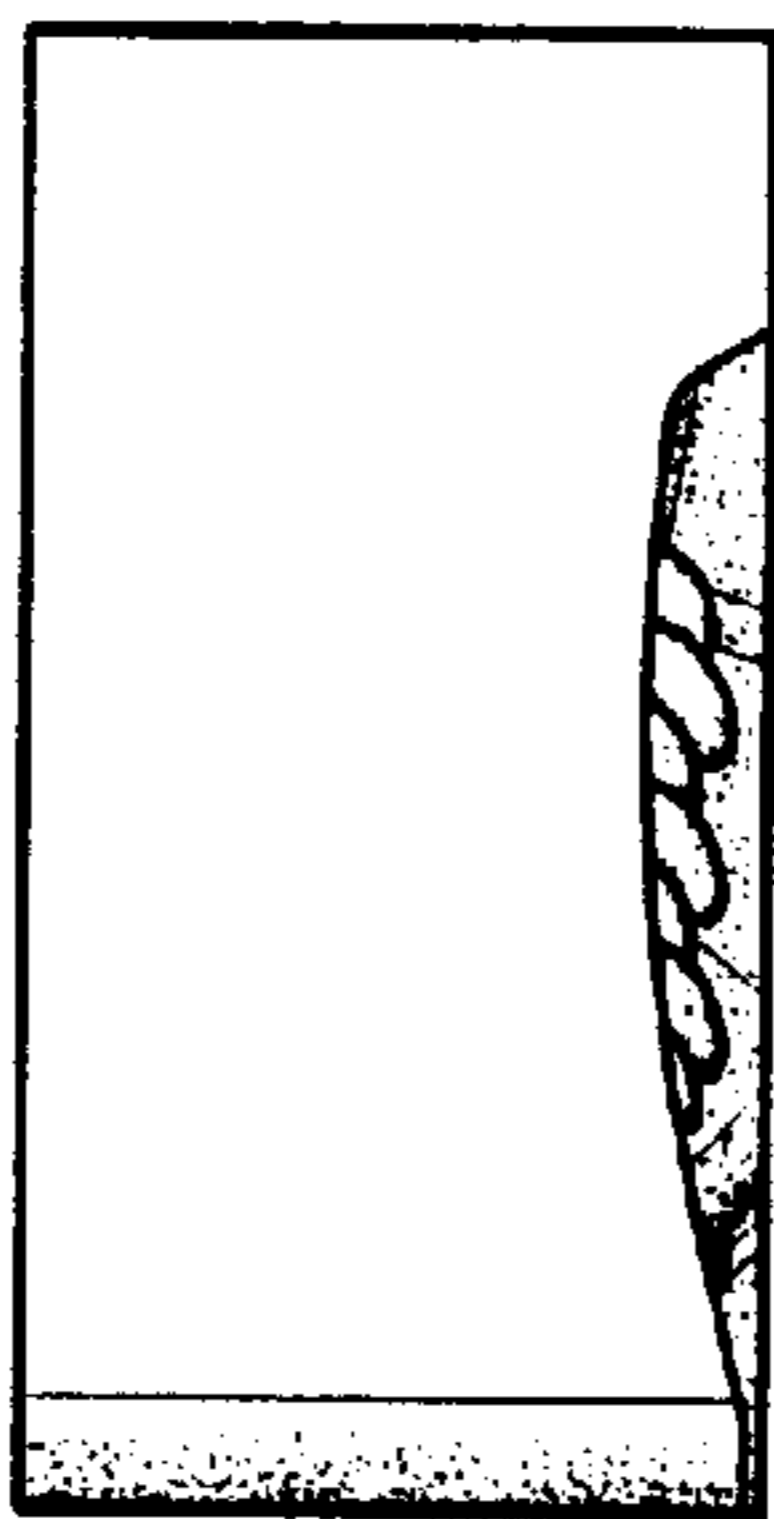

FIG. 5

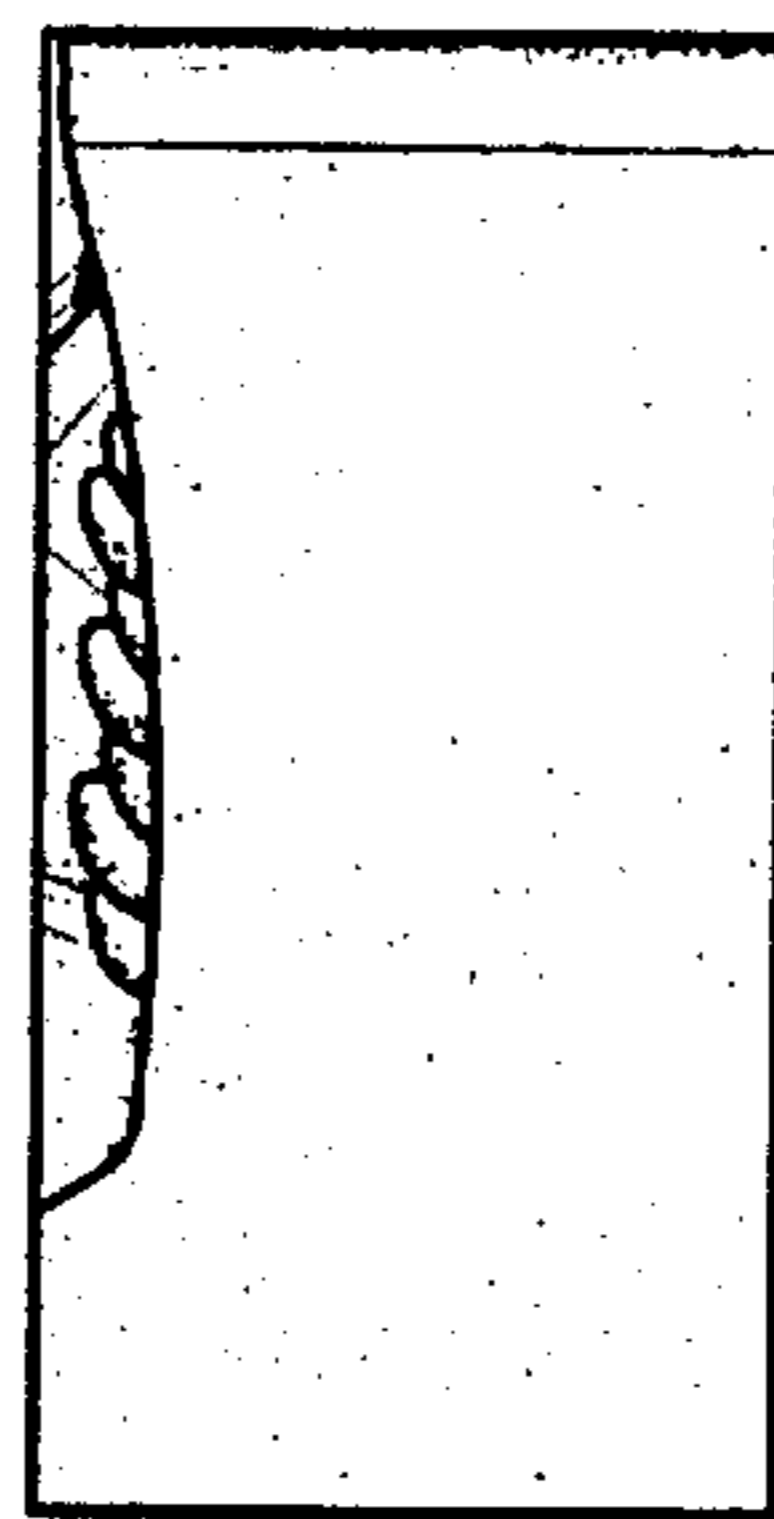

FIG. 6

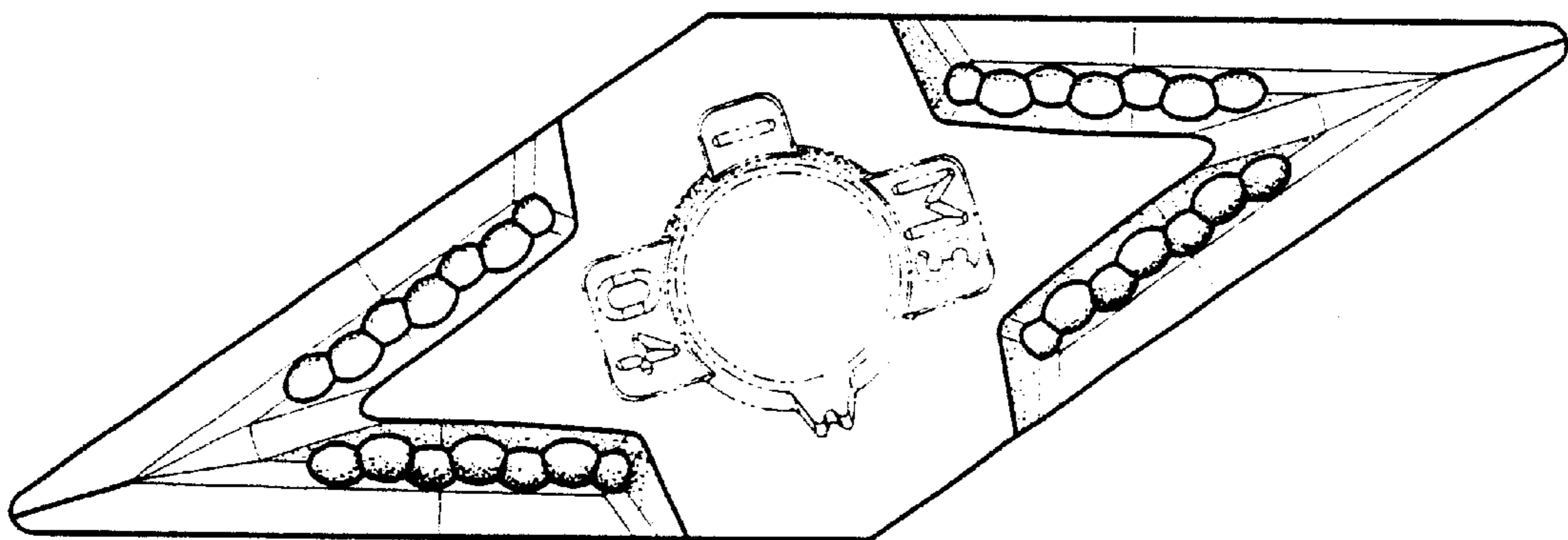

FIG. 7

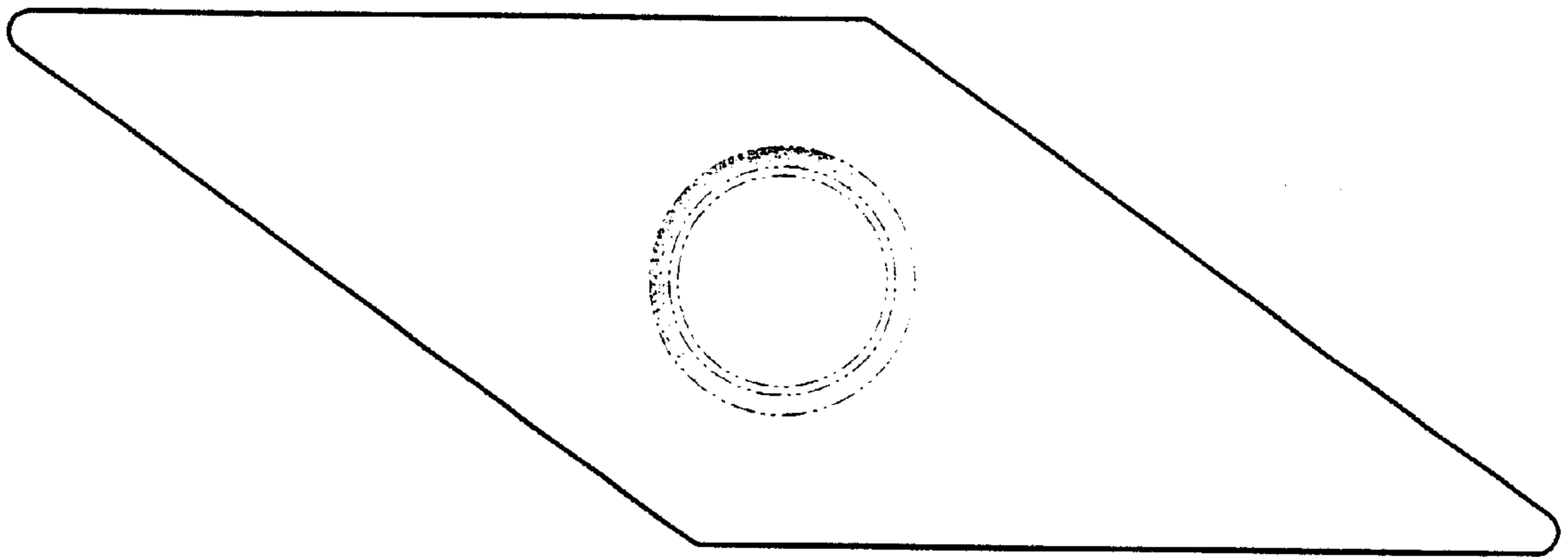

FIG. 8