



US00D487714S

(12) **United States Design Patent**
Weiser et al.

(10) **Patent No.:** **US D487,714 S**
(45) **Date of Patent:** **** Mar. 23, 2004**

- (54) **FLAMINGO-PLANTER-FEEDER**
- (75) Inventors: **Isaac Weiser**, Tarzana, CA (US);
Margaret Weiser, Tarzana, CA (US)
- (73) Assignee: **Exhart Environmental Systems, Inc.**,
Chatsworth, CA (US)
- (**) Term: **14 Years**
- (21) Appl. No.: **29/179,701**
- (22) Filed: **Apr. 11, 2003**
- (51) **LOC (7) Cl.** **11-02**
- (52) **U.S. Cl.** **D11/149**
- (58) **Field of Search** D11/58, 143, 144,
D11/148, 149, 151; D30/124, 125; D21/606;
119/51.01, 52.2, 52.3, 57.8, 57.9; 47/41.01,
65.5, 66.6, 67; 206/423; 248/27.8

- D360,381 S * 7/1995 Ternyiki et al. D11/149
- D384,598 S * 10/1997 Park D11/162
- D394,463 S * 5/1998 Filho D11/162
- D460,383 S * 7/2002 Weiser et al. D11/149
- D463,511 S * 9/2002 Weiser et al. D21/606
- D479,633 S * 9/2003 Weiser et al. D30/125

* cited by examiner

Primary Examiner—Doris V. Coles
Assistant Examiner—Mimosa De
(74) *Attorney, Agent, or Firm*—Cislo & Thomas LLP

(57) **CLAIM**

The ornamental design for a flamingo-planter-feeder, as shown and described.

DESCRIPTION

FIG. 1. Is a front perspective view of our flamingo-planter feeder with the dotted line shown being for illustrative purposes only and to which no claim is made;
FIG. 2. Is a right side elevational view with the left side elevational view being a mirror image thereof;
FIG. 3. Is a front elevational view thereof;
FIG. 4. Is a rear elevational view thereof;
FIG. 5. Is a top plan view thereof; and,
FIG. 6. Is a bottom plan view thereof.

1 Claim, 5 Drawing Sheets

(56) **References Cited**

U.S. PATENT DOCUMENTS

- D77,348 S * 1/1929 Axell D11/149
- D141,469 S * 6/1945 Katz D11/58
- D191,115 S * 8/1961 Okamoto D21/606
- 3,290,817 A * 12/1966 Kravath 446/227
- D315,371 S * 3/1991 Van Risseghem et al. . D21/467

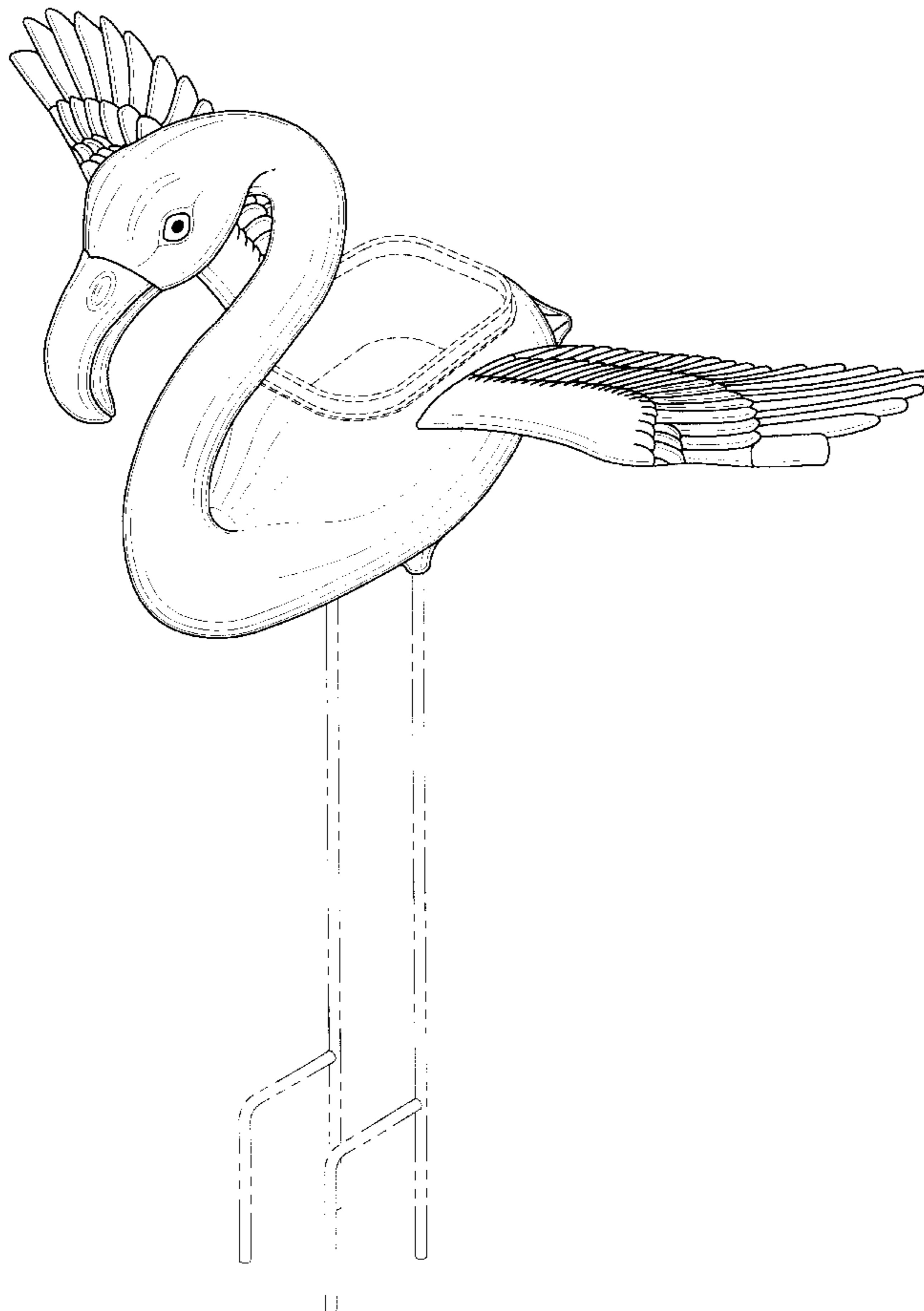

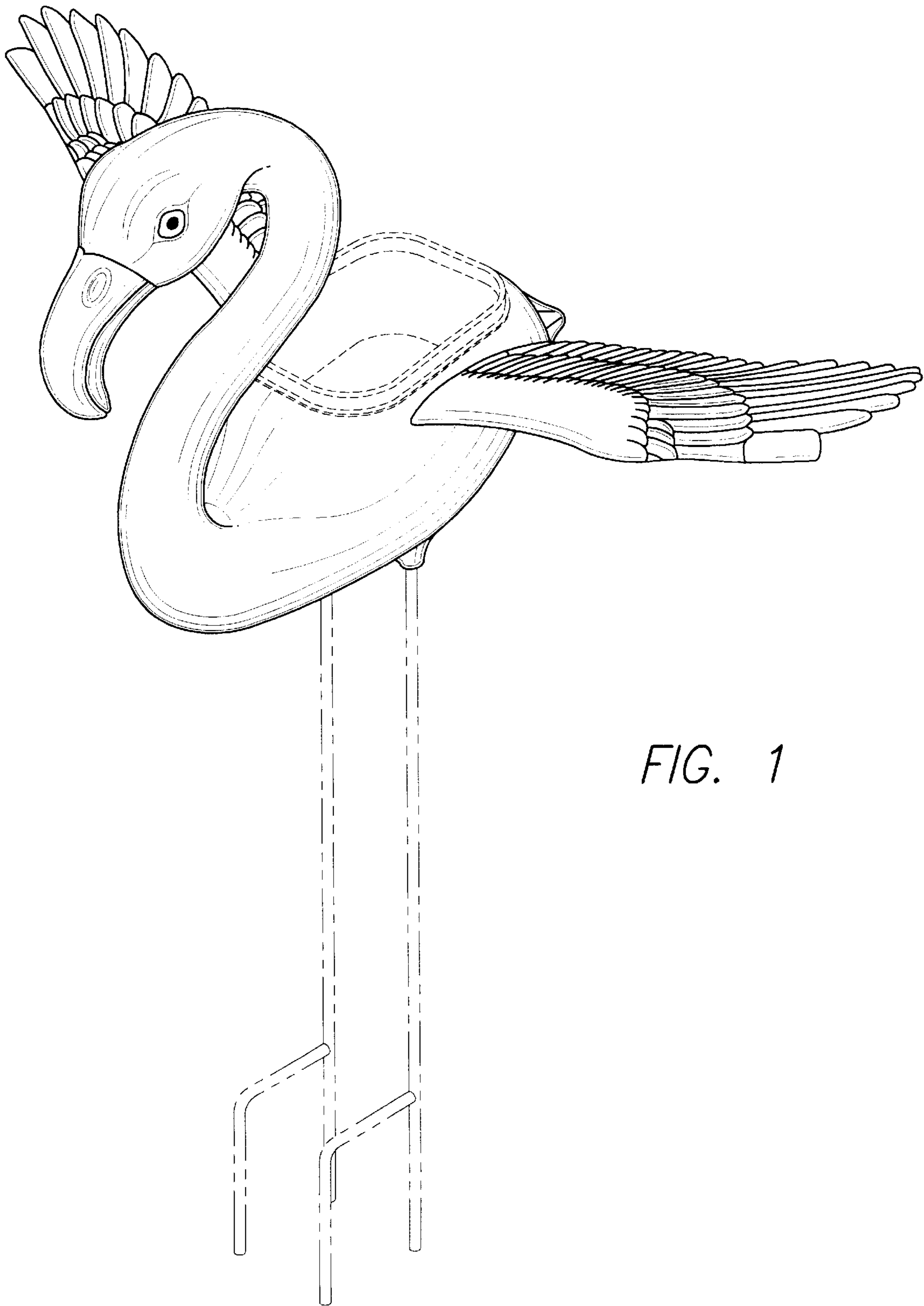

FIG. 1

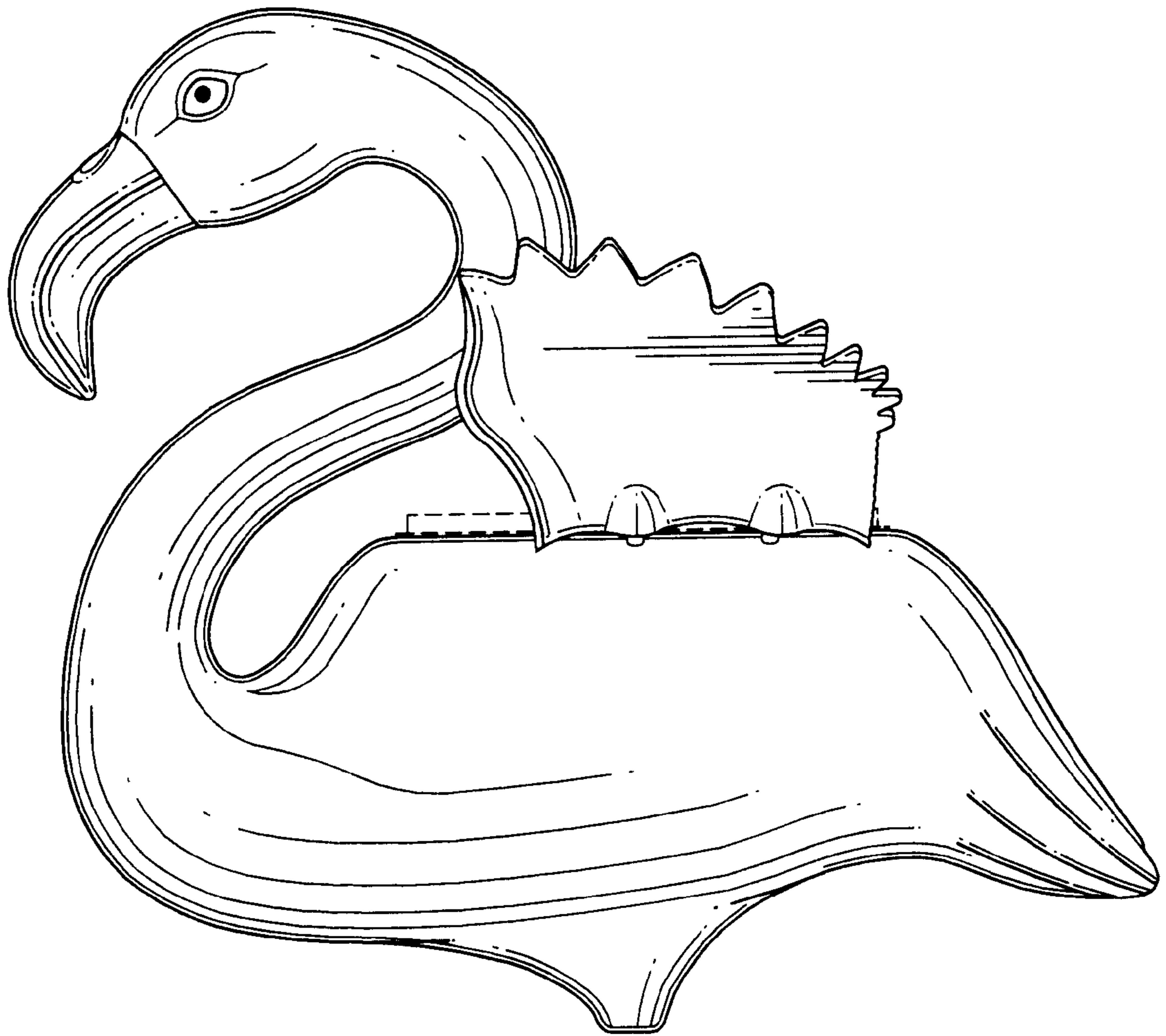

FIG. 2

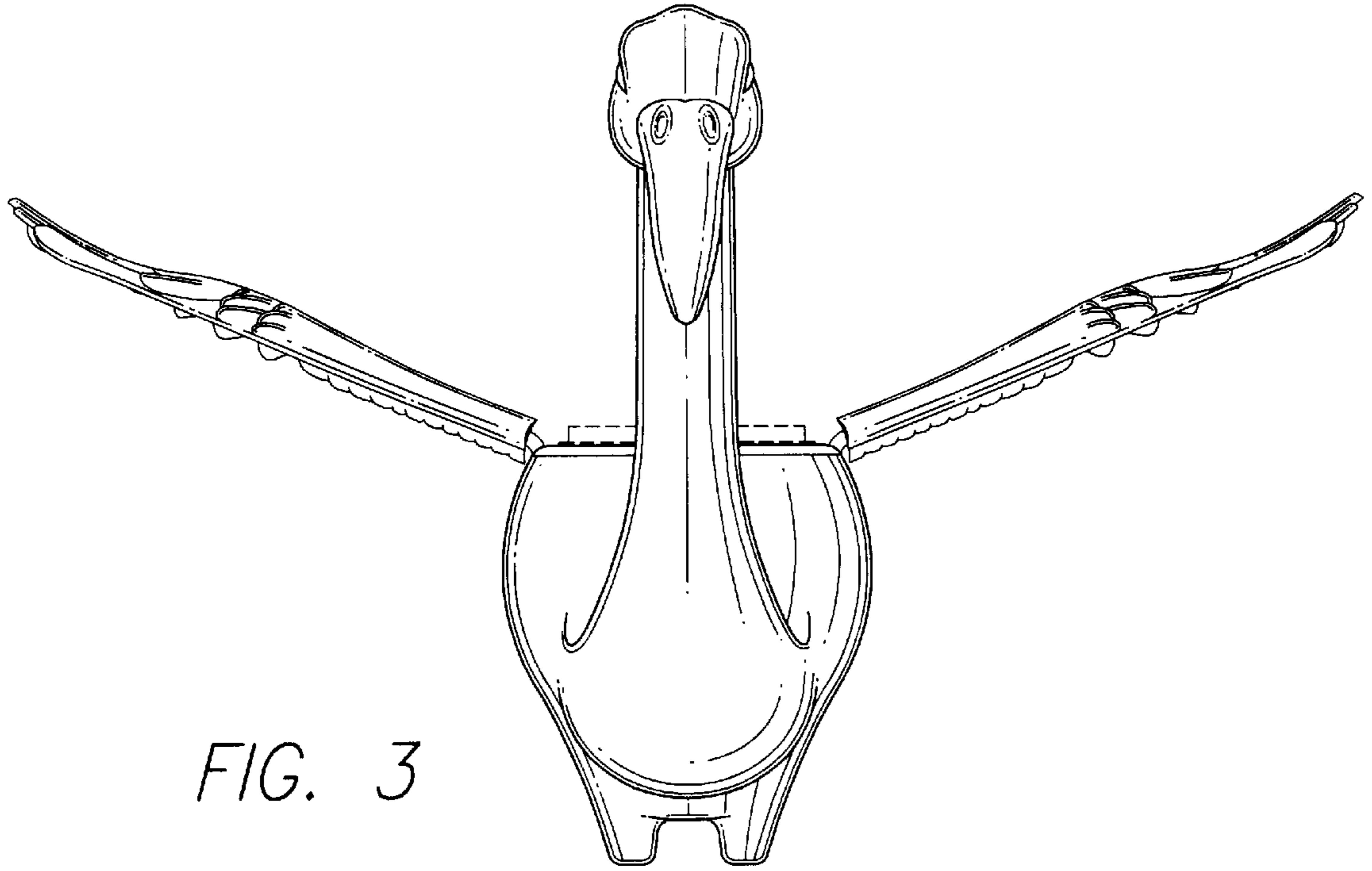

FIG. 3

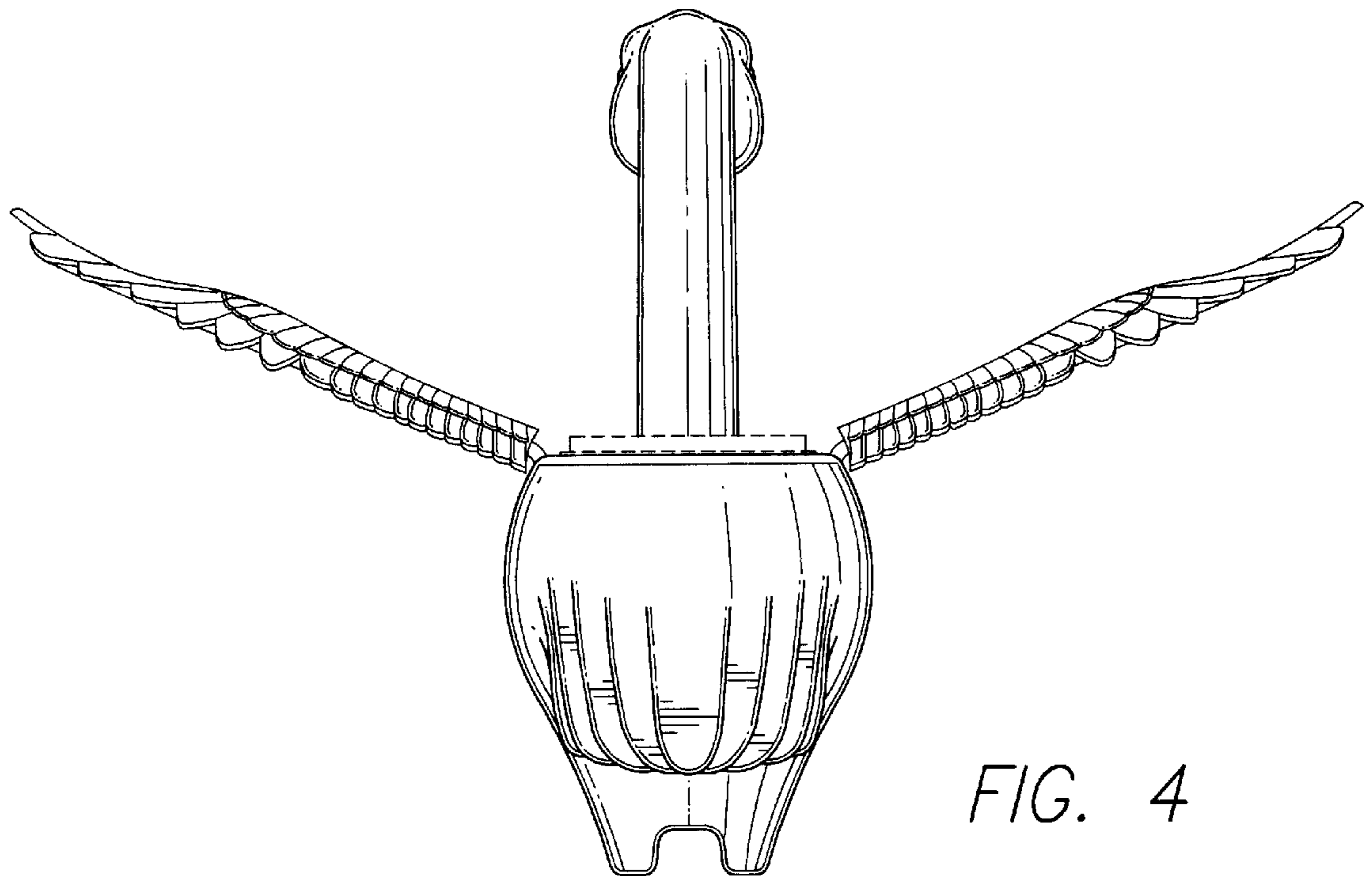

FIG. 4

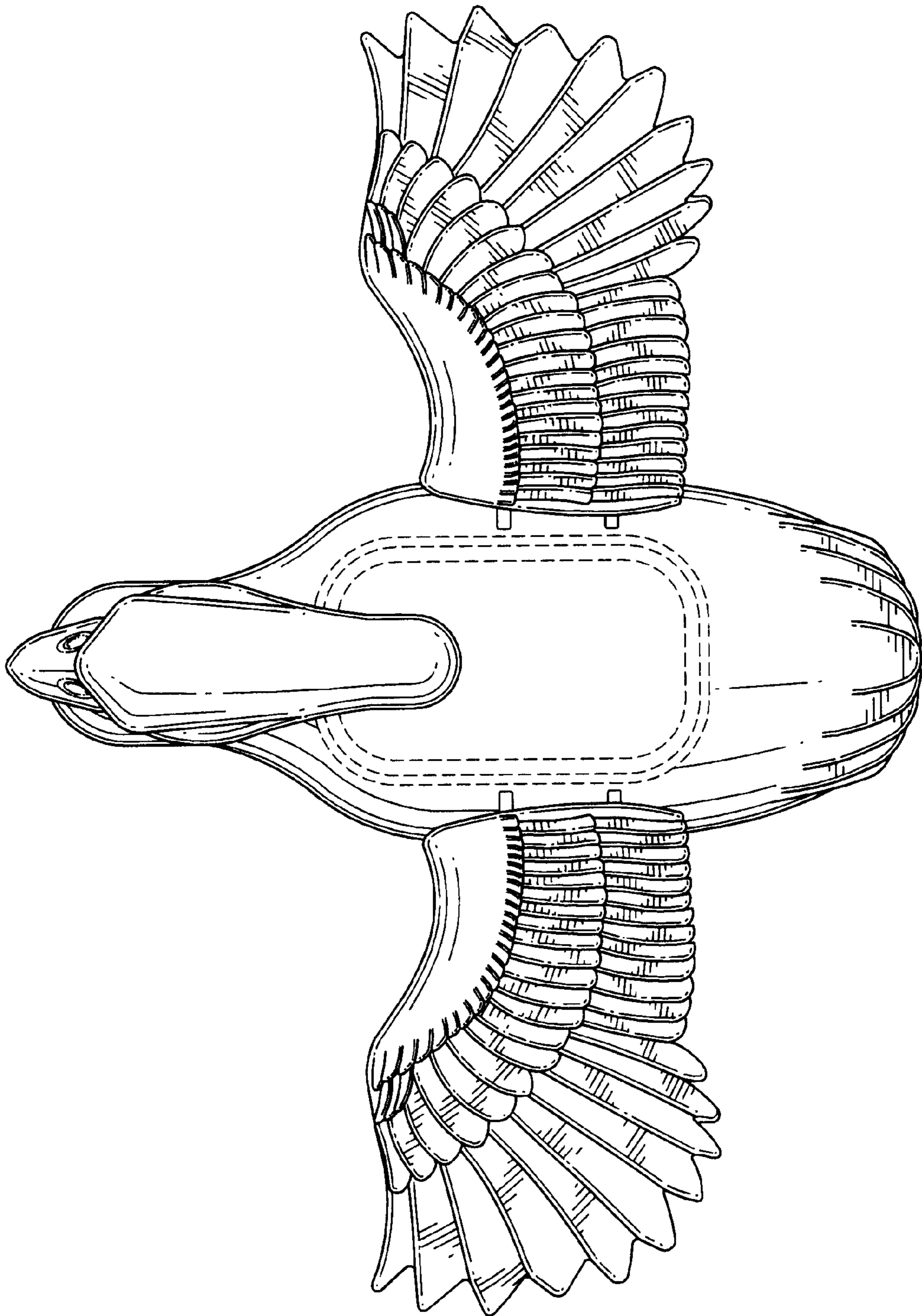

FIG. 5

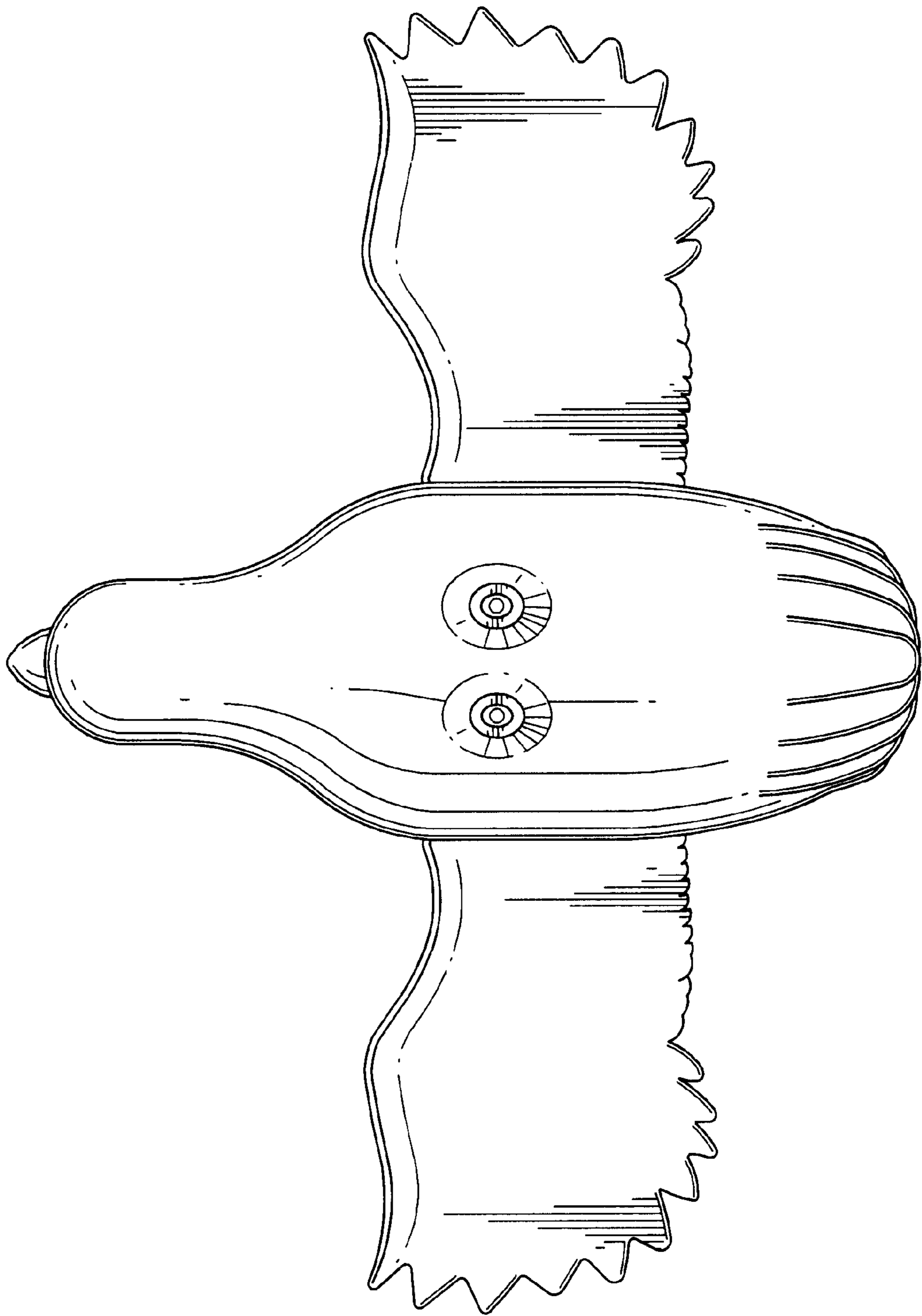

FIG. 6