



US00D487599S

(12) **United States Design Patent**
Hsu

(10) **Patent No.:** **US D487,599 S**

(45) **Date of Patent:** **** Mar. 16, 2004**

(54) **WALL LAMP**

(75) **Inventor:** **Kevin Hsu, Taichung (TW)**

(73) **Assignee:** **Dong Guan Bright Yin Huey Lighting Co., Ltd., Guang Dong (CN)**

(**) **Term:** **14 Years**

(21) **Appl. No.:** **29/177,289**

(22) **Filed:** **Mar. 10, 2003**

(51) **LOC (7) Cl. 26-03**

(52) **U.S. Cl. D26/80; D26/92**

(58) **Field of Search D26/72, 80-92;**
362/147, 363, 367, 368, 404-408, 432

(56) **References Cited**

U.S. PATENT DOCUMENTS

D71,806 S	*	1/1927	Levitan	D26/92
D76,165 S	*	8/1928	Strom	D26/80
D457,678 S	*	5/2002	Yang	D26/80

OTHER PUBLICATIONS

Progress Lighting Product Catalog #124 (c)2000; p. 231; fixture in top of photo.*

* cited by examiner

Primary Examiner—Clare E. Heflin

(74) *Attorney, Agent, or Firm*—Rosenberg, Klein & Lee

(57) **CLAIM**

The ornamental design for a wall lamp, as shown and described.

DESCRIPTION

FIG. 1 is a perspective view of wall lamp showing my new design;
FIG. 2 is a front elevation view thereof;
FIG. 3 is a rear elevation view thereof;
FIG. 4 is a left side elevation view thereof;
FIG. 5 is a right side elevation view thereof;
FIG. 6 is a top plan view thereof; and,
FIG. 7 is a bottom plan view thereof.

1 Claim, 5 Drawing Sheets

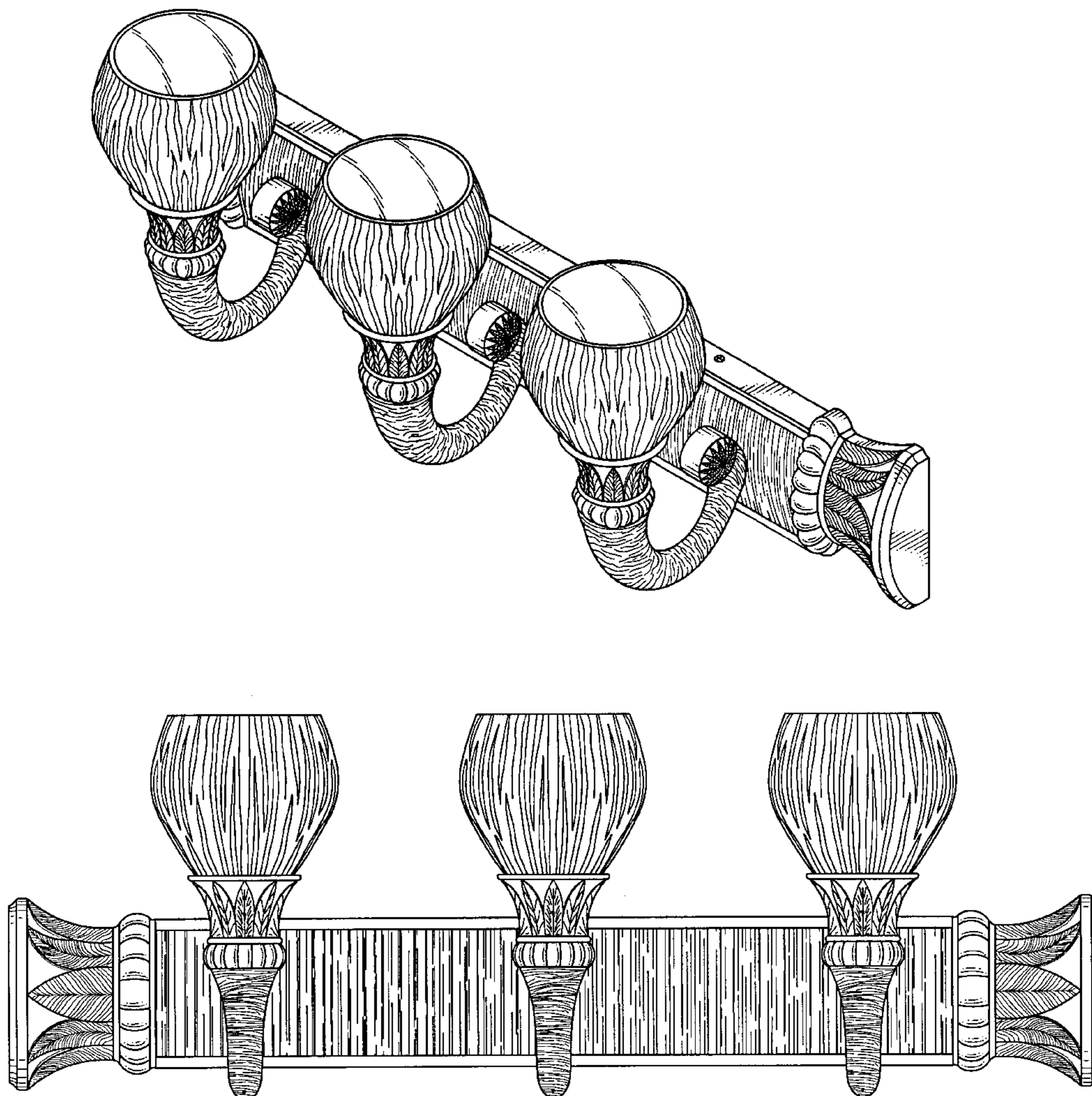

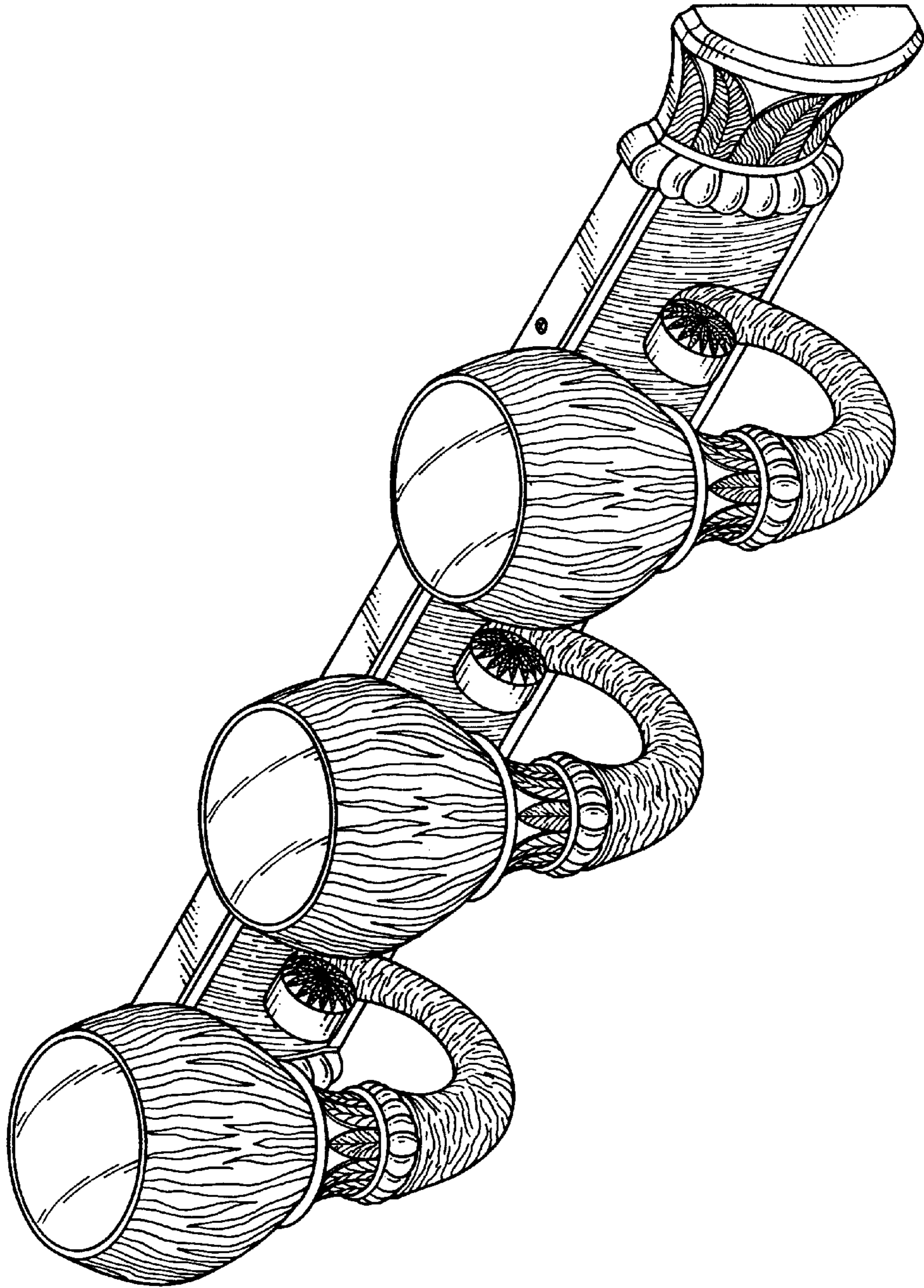

FIG. 1

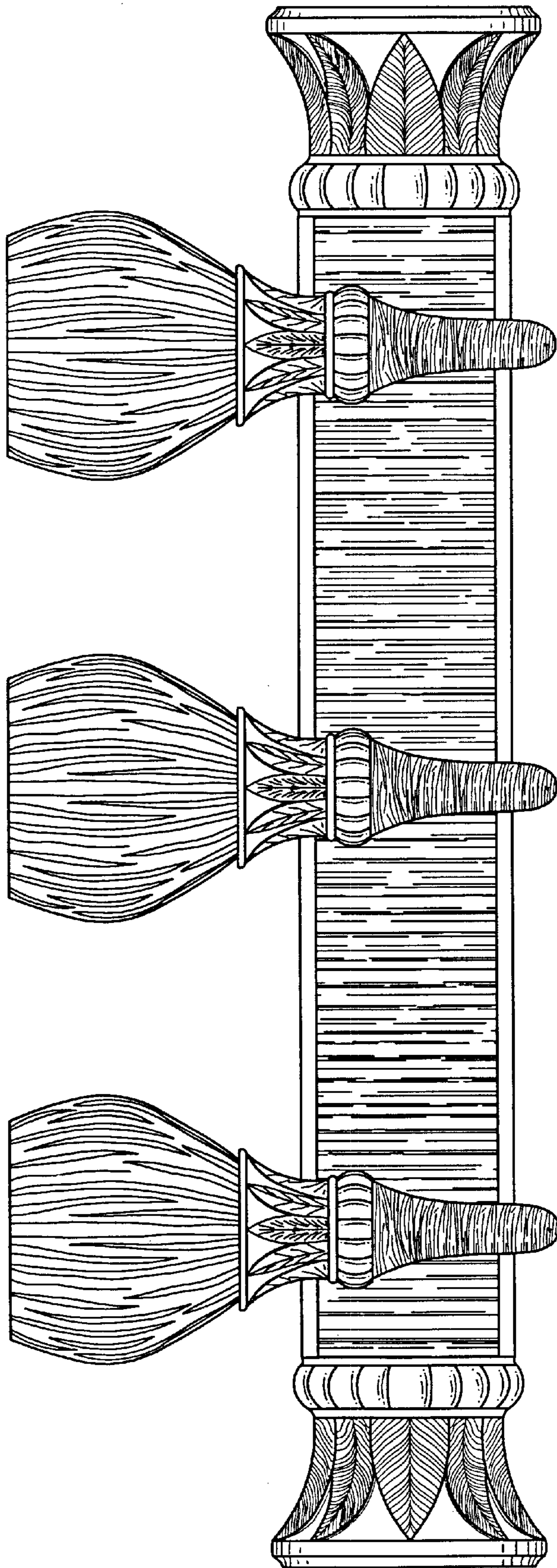

FIG. 2

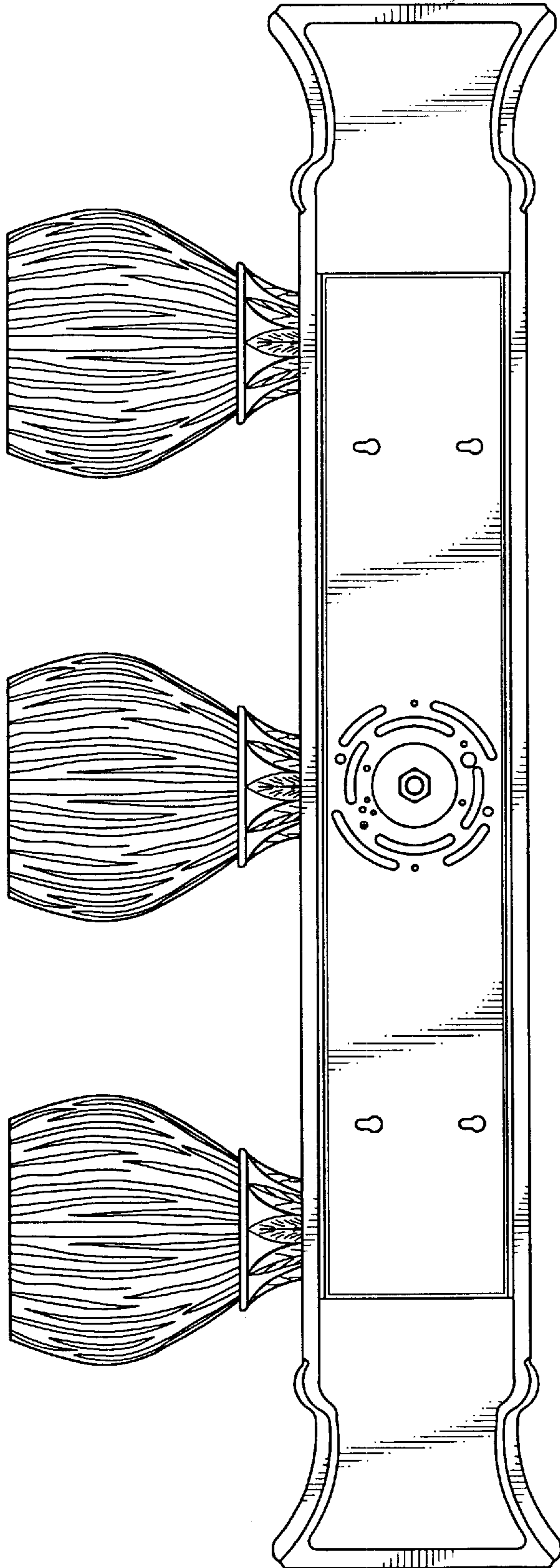

FIG. 3

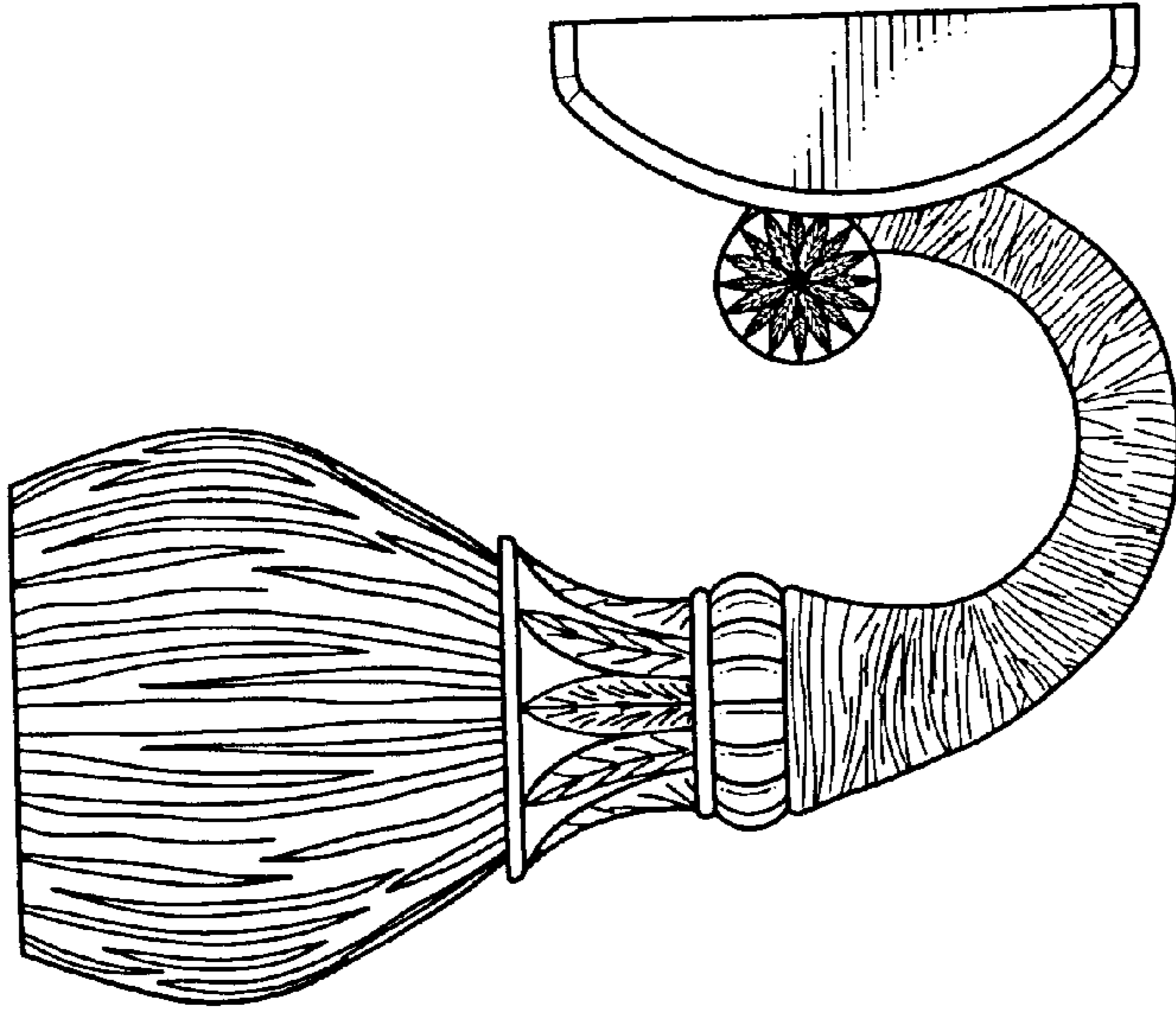

FIG. 5

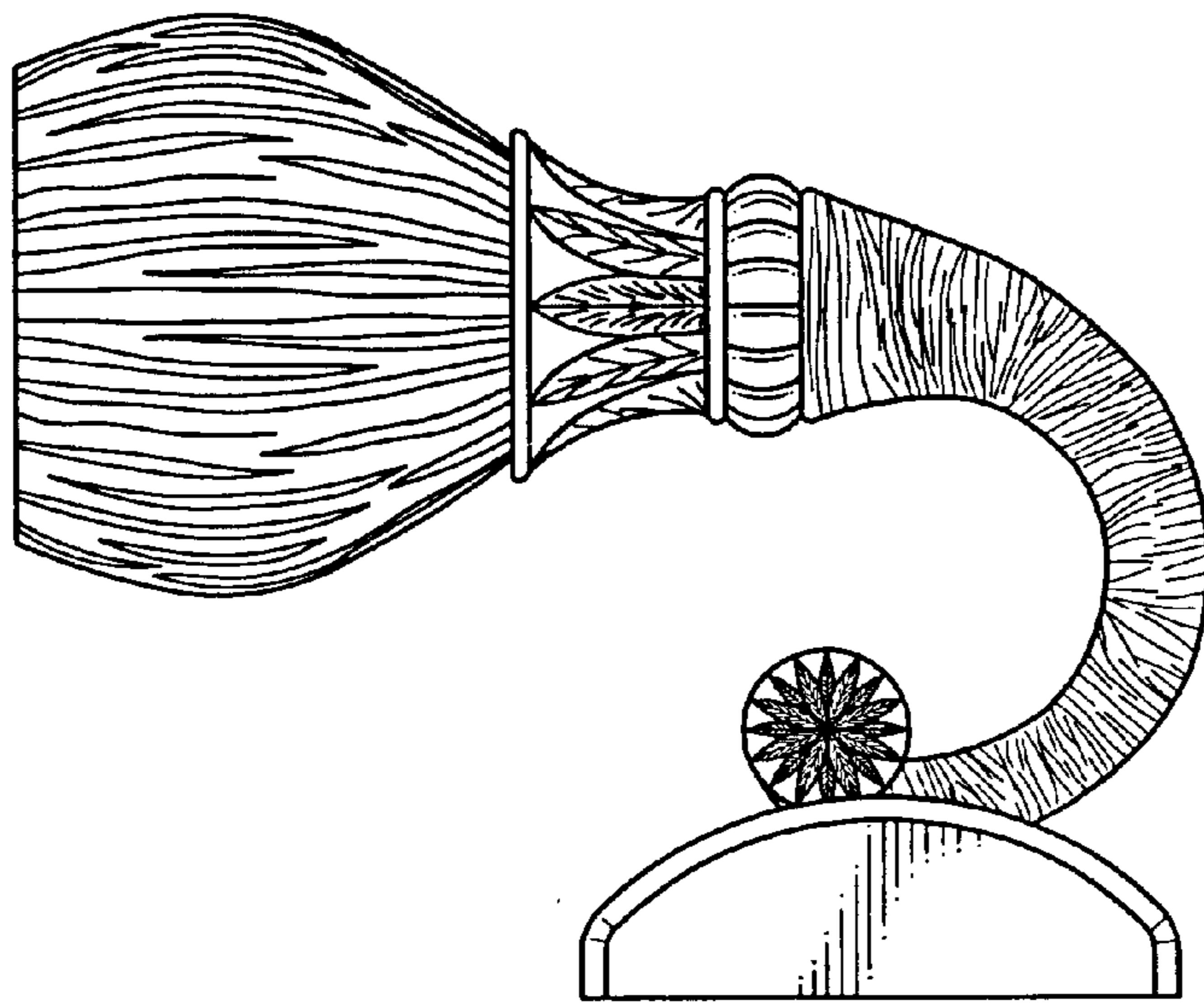

FIG. 4

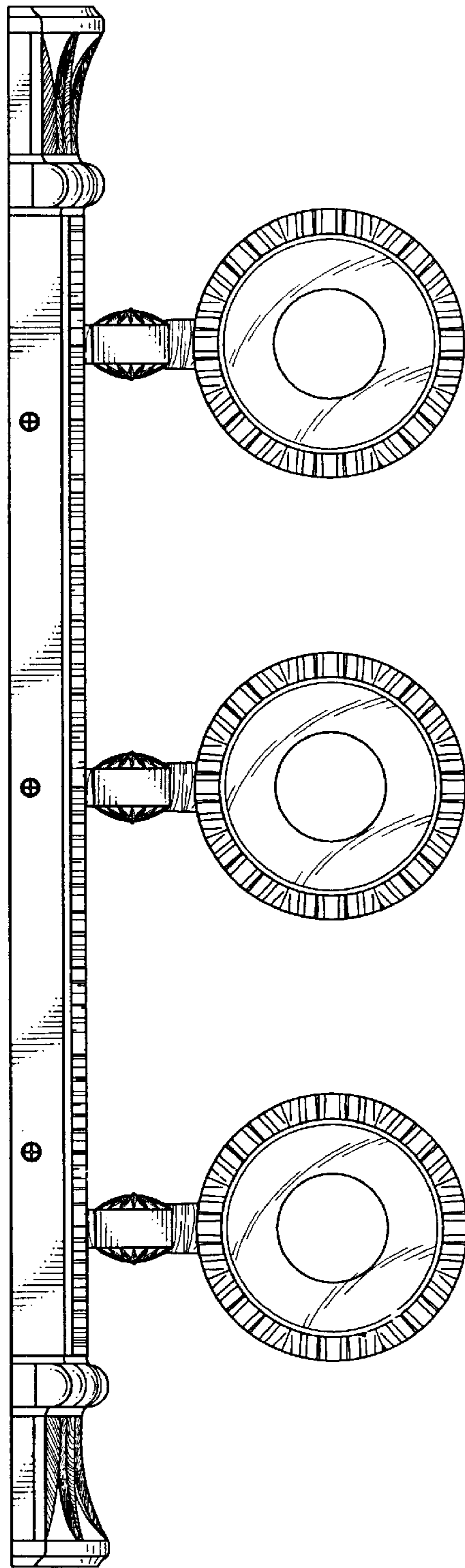

FIG. 6

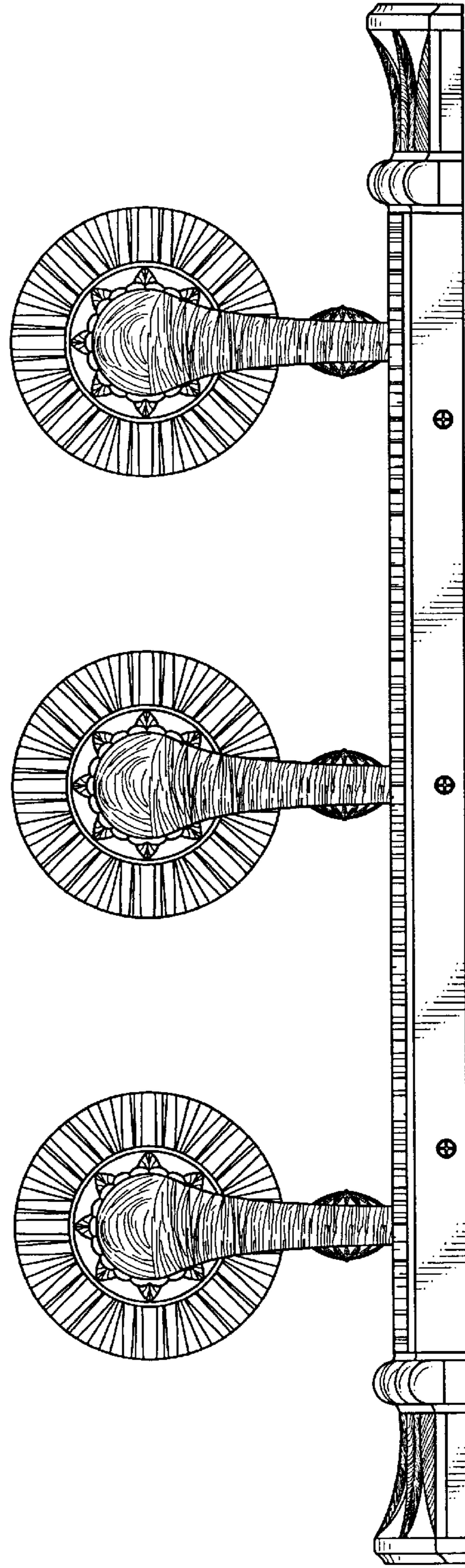

FIG. 7