



US00D487536S

(12) **United States Design Patent**
Ågren

(10) **Patent No.:** **US D487,536 S**

(45) **Date of Patent:** **** Mar. 9, 2004**

(54) **FEATHER DUSTER HOLDER VACUUM CLEANER ACCESSORY**

(75) Inventor: **Christian Ågren**, Stockholm (SE)

(73) Assignee: **Aktiebolaget Electrolux**, Stockholm (SE)

(**) Term: **14 Years**

(21) Appl. No.: **29/157,439**

(22) Filed: **Mar. 18, 2002**

(30) **Foreign Application Priority Data**

Sep. 19, 2001 (SE) 01-1536

(51) **LOC (7) Cl.** **15-05**

(52) **U.S. Cl.** **D32/31**

(58) **Field of Search** D32/31-33, 21, D32/22, 23, 25, 40, 42; 15/415.1-422.1, 321-322, 400, 414, 246.2, 323, 105, 1.52

(56) **References Cited**

U.S. PATENT DOCUMENTS

D291,129	S	*	7/1987	Lackner et al.	D32/31
5,732,438	A	*	3/1998	Tuvin et al.	15/323
D411,359	S	*	6/1999	Green	D32/31
D426,358	S	*	6/2000	Saunders et al.	D32/31
6,070,288	A	*	6/2000	Luyckx et al.	15/323
D434,886	S	*	12/2000	Wareham et al.	D32/31
6,406,507	B1	*	6/2002	Paterson et al.	55/378
D463,079	S	*	9/2002	Leyden	D32/31
6,446,293	B2	*	9/2002	Lindquist et al.	15/1.52

* cited by examiner

Primary Examiner—Ruth McInroy

(74) *Attorney, Agent, or Firm*—Pearne & Gordon LLP

(57) **CLAIM**

The ornamental design for a feather duster holder vacuum cleaner accessory, as shown and described.

DESCRIPTION

FIG. 1 is a perspective view of a feather duster holder vacuum cleaner accessory showing my new design without the feather duster;

FIG. 2 is a left side elevation view thereof;

FIG. 3 is a top plan view thereof;

FIG. 4 is a rear elevation view thereof;

FIG. 5 is a right side elevation view thereof;

FIG. 6 is a front elevation view thereof;

FIG. 7 is a bottom plan view thereof;

FIG. 8 is a top plan view of a feather duster;

FIG. 9 is a rear elevation view thereof;

FIG. 10 is a front elevation view thereof;

FIG. 11 is a left side elevation view thereof, the right side being a mirror image thereof;

FIG. 12 is a perspective view of a feather duster holder vacuum cleaner accessory in assembled condition;

FIG. 13 is a left side elevation view thereof;

FIG. 14 is a top plan view thereof;

FIG. 15 is a rear elevation view thereof;

FIG. 16 is a right elevation view thereof;

FIG. 17 is a front elevation view thereof; and,

FIG. 18 is a bottom elevation view thereof.

The claim is directed to the feather duster holder vacuum cleaner accessory shown in FIGS. 12-18. FIGS. 1-11 are shown separate for clarity of illustration.

1 Claim, 7 Drawing Sheets

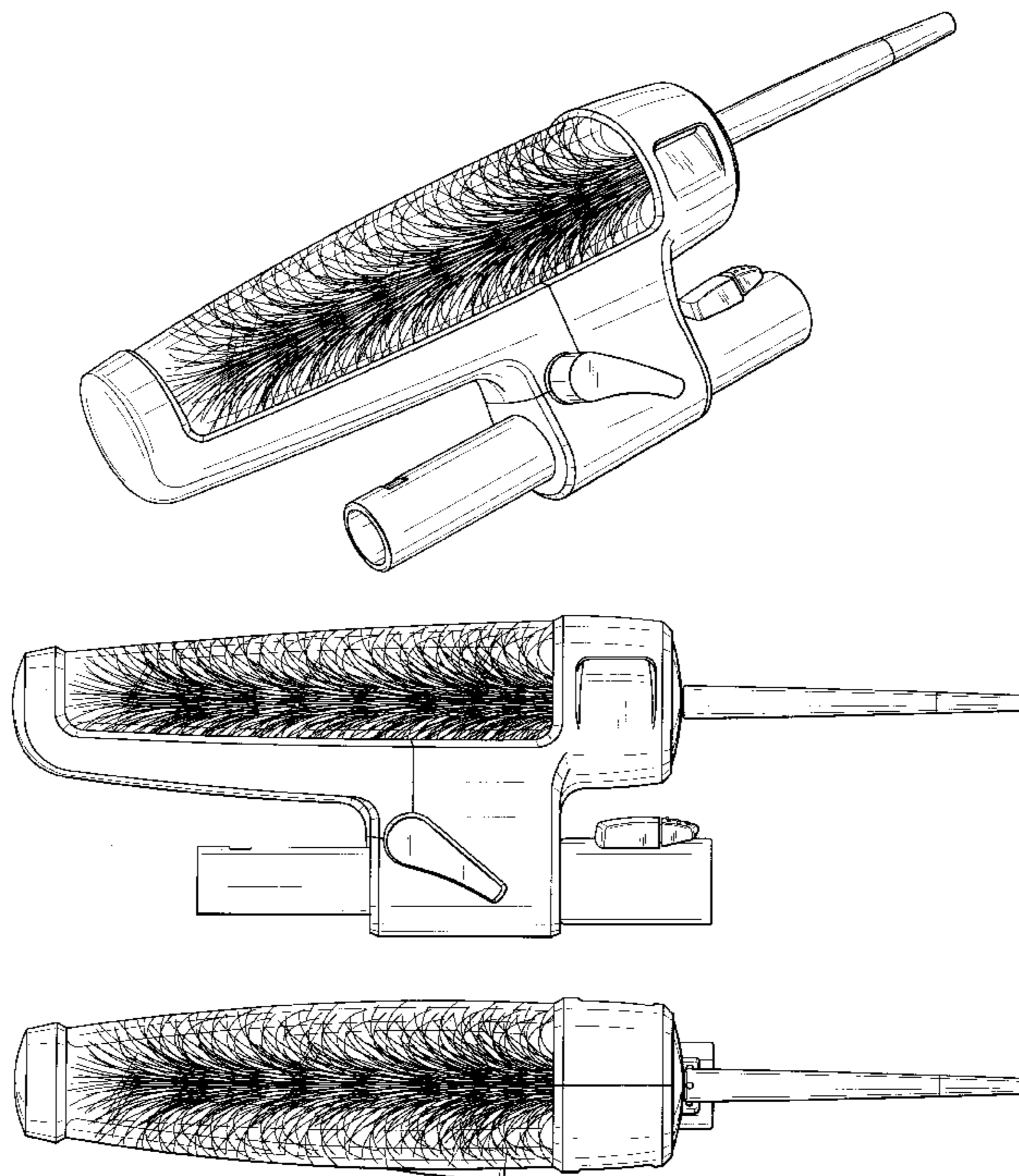

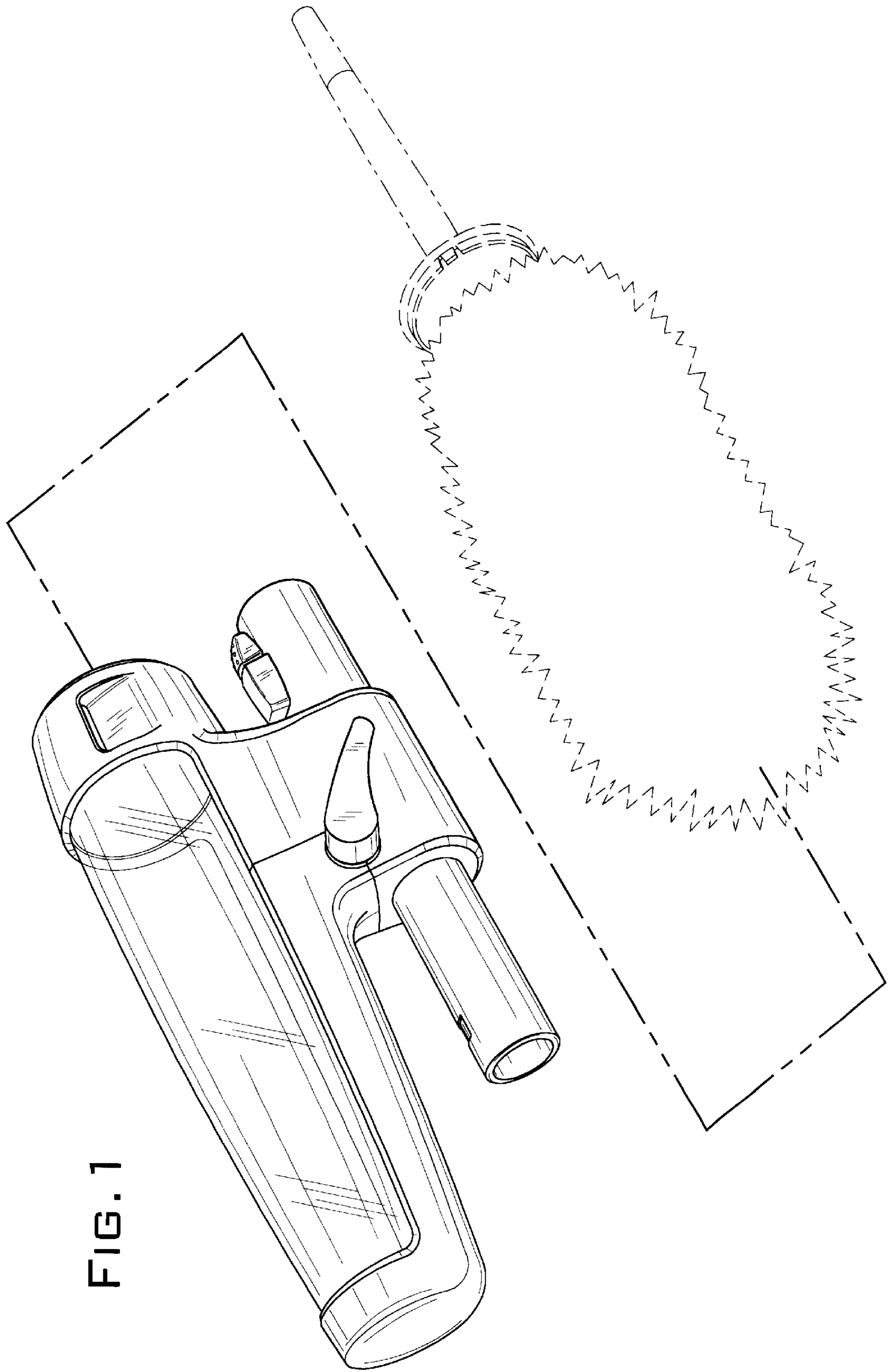

FIG. 1

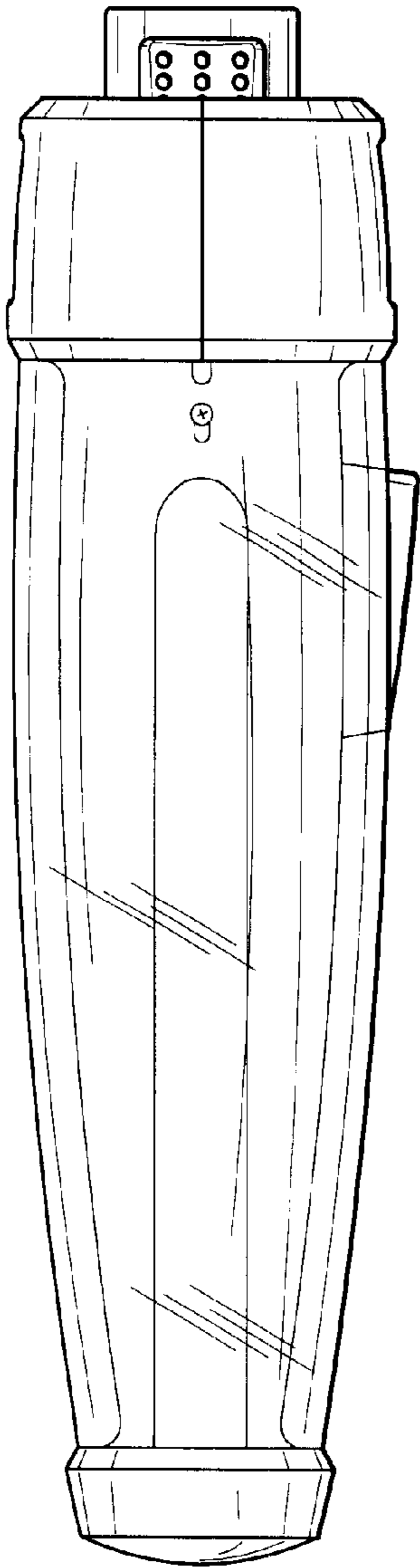

FIG. 3

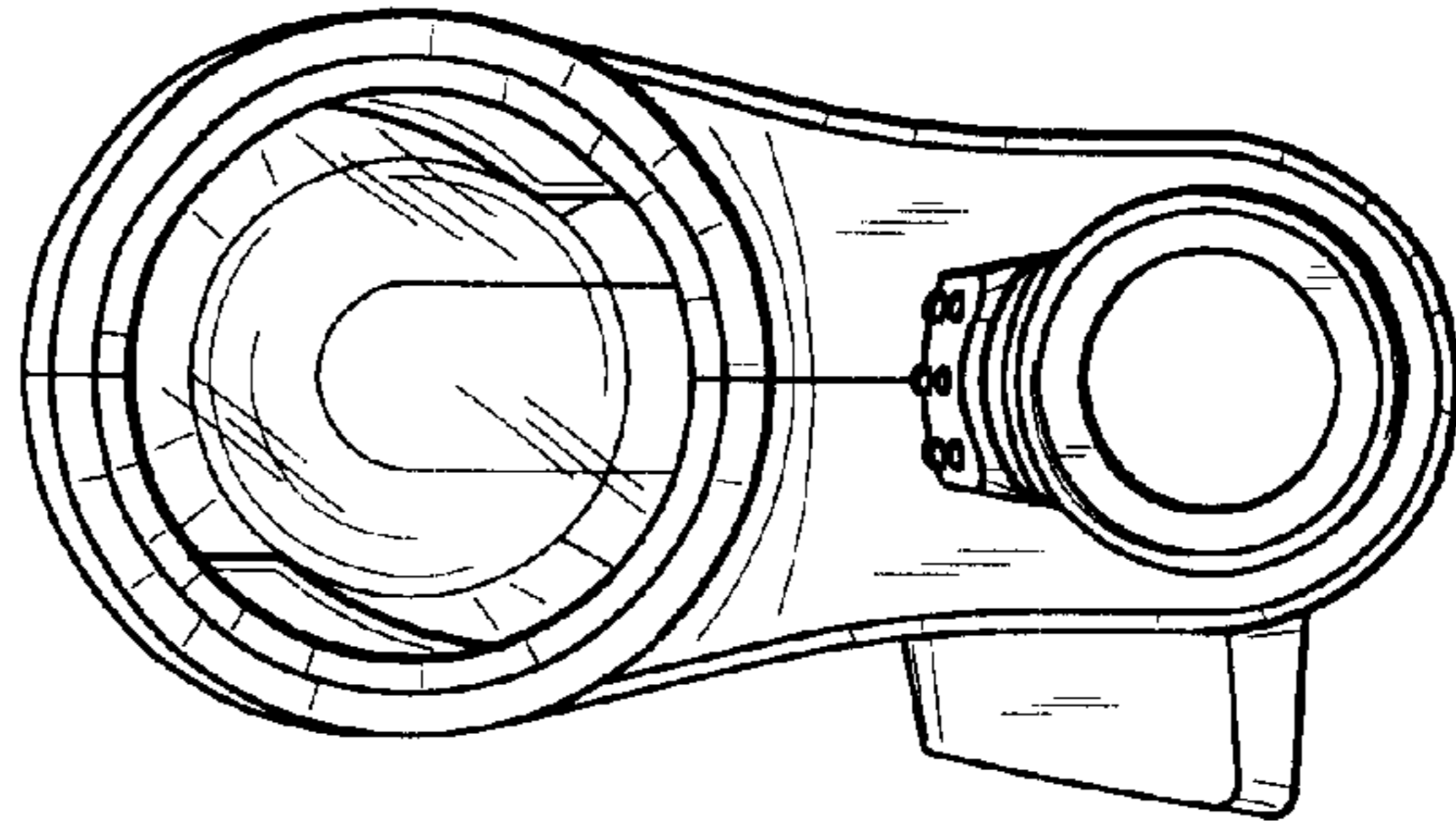

FIG. 4

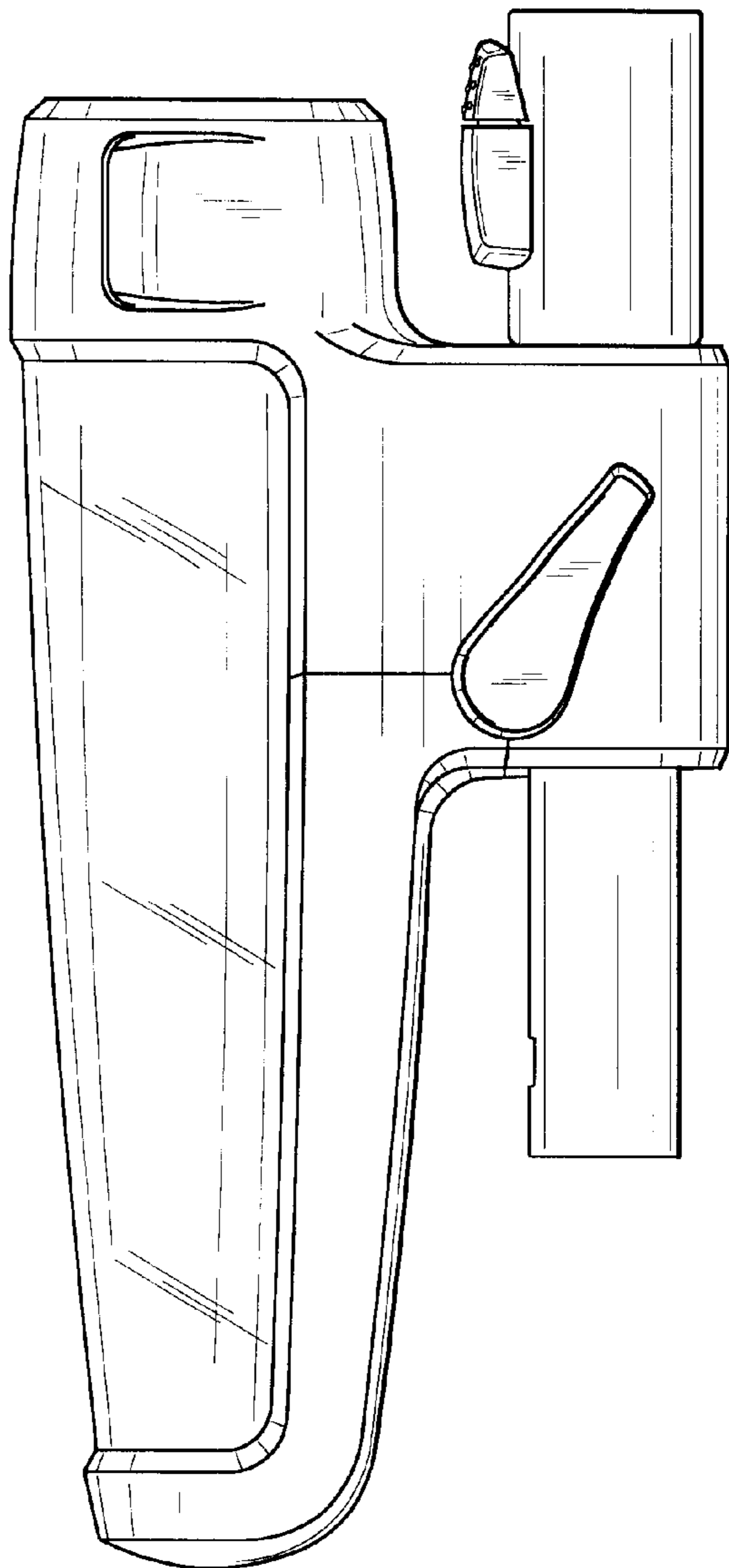

FIG. 2

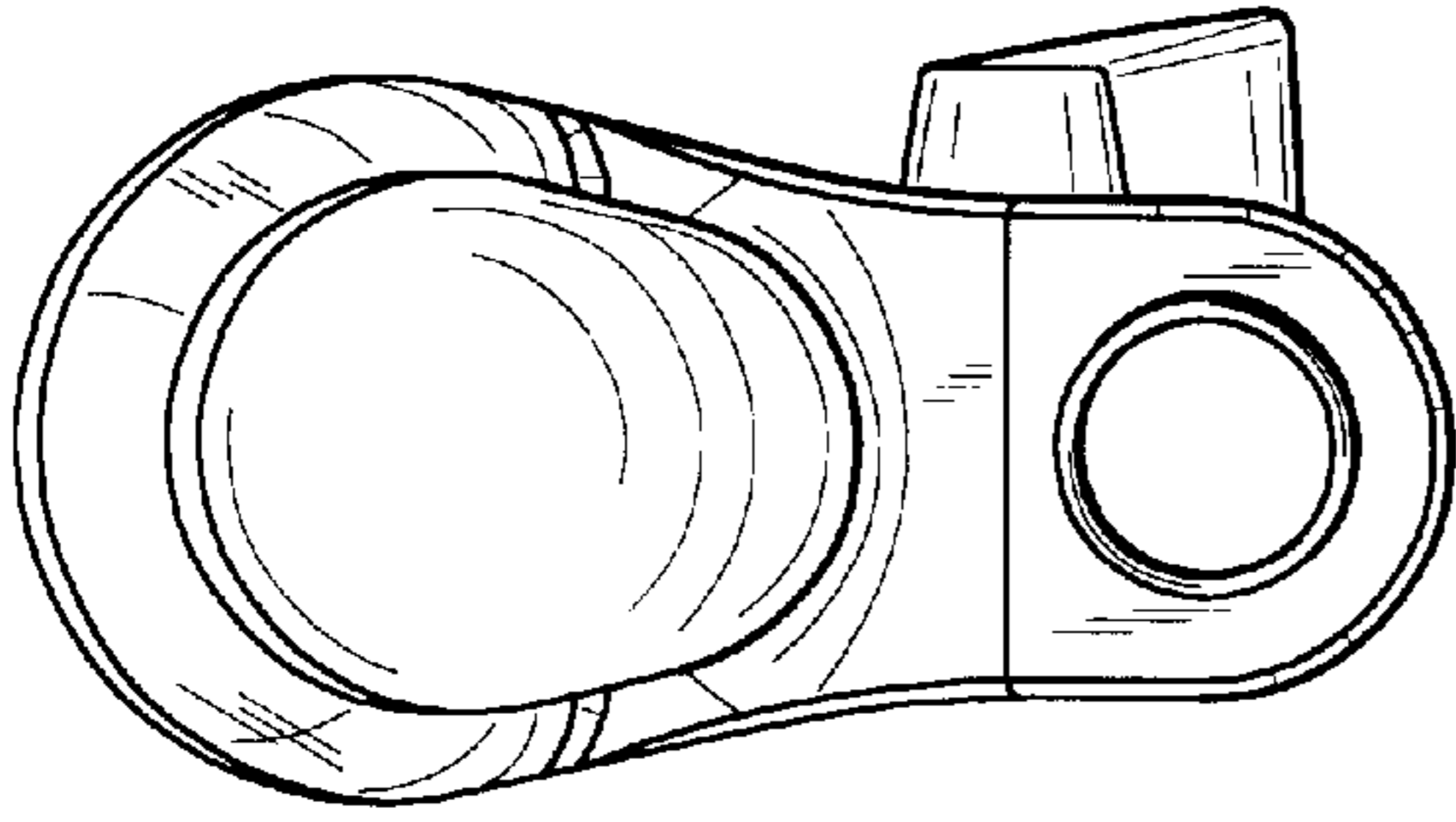

FIG. 6

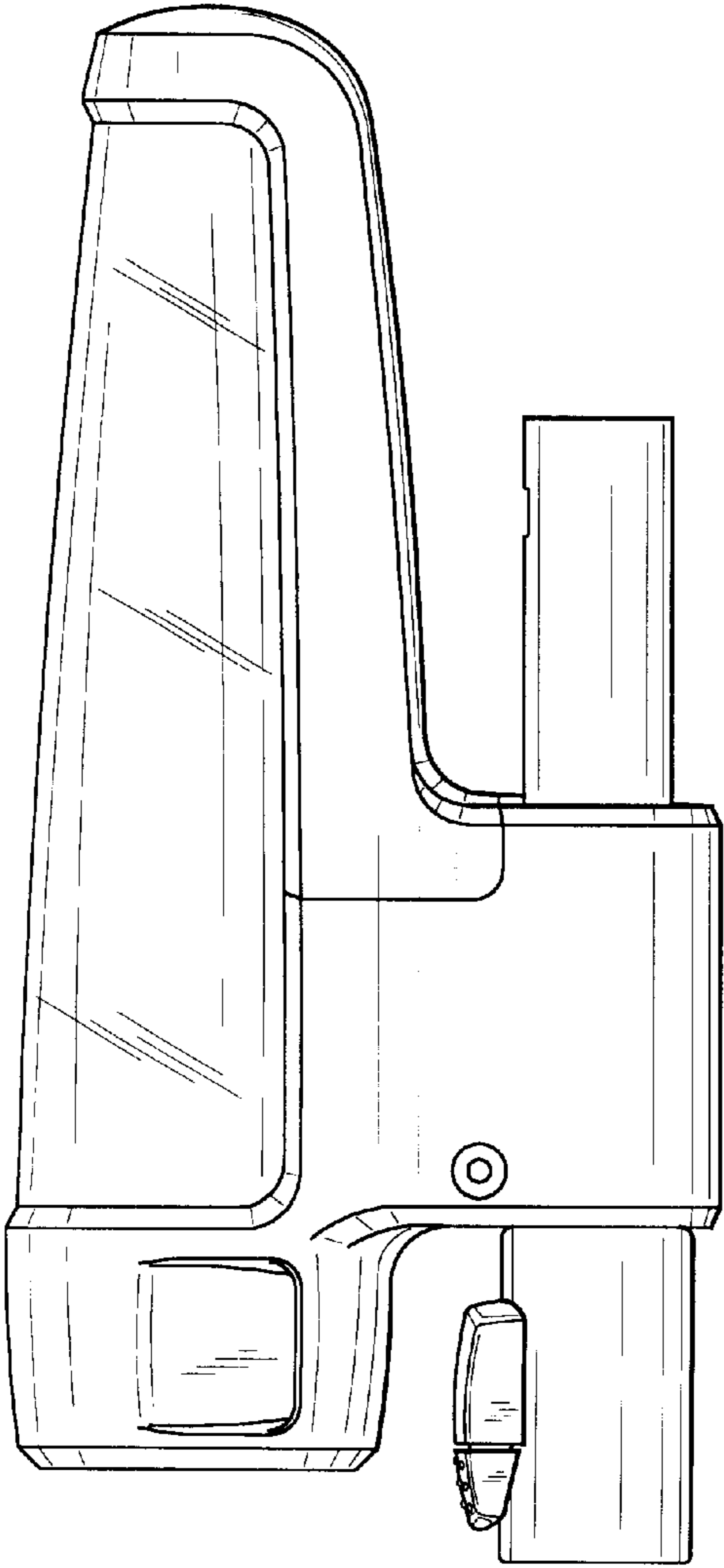

FIG. 5

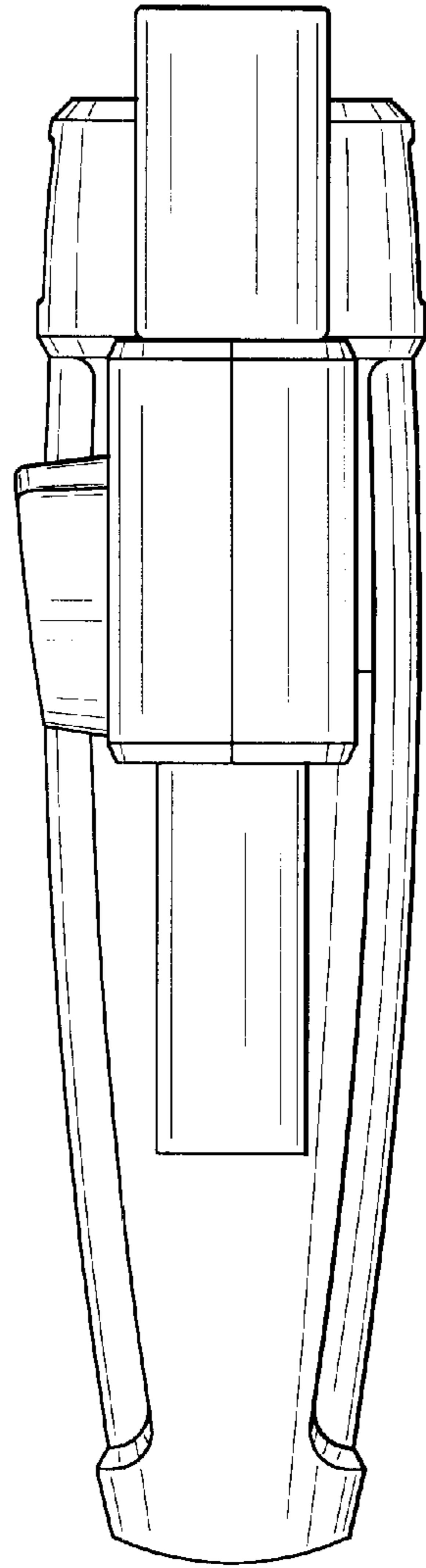

FIG. 7

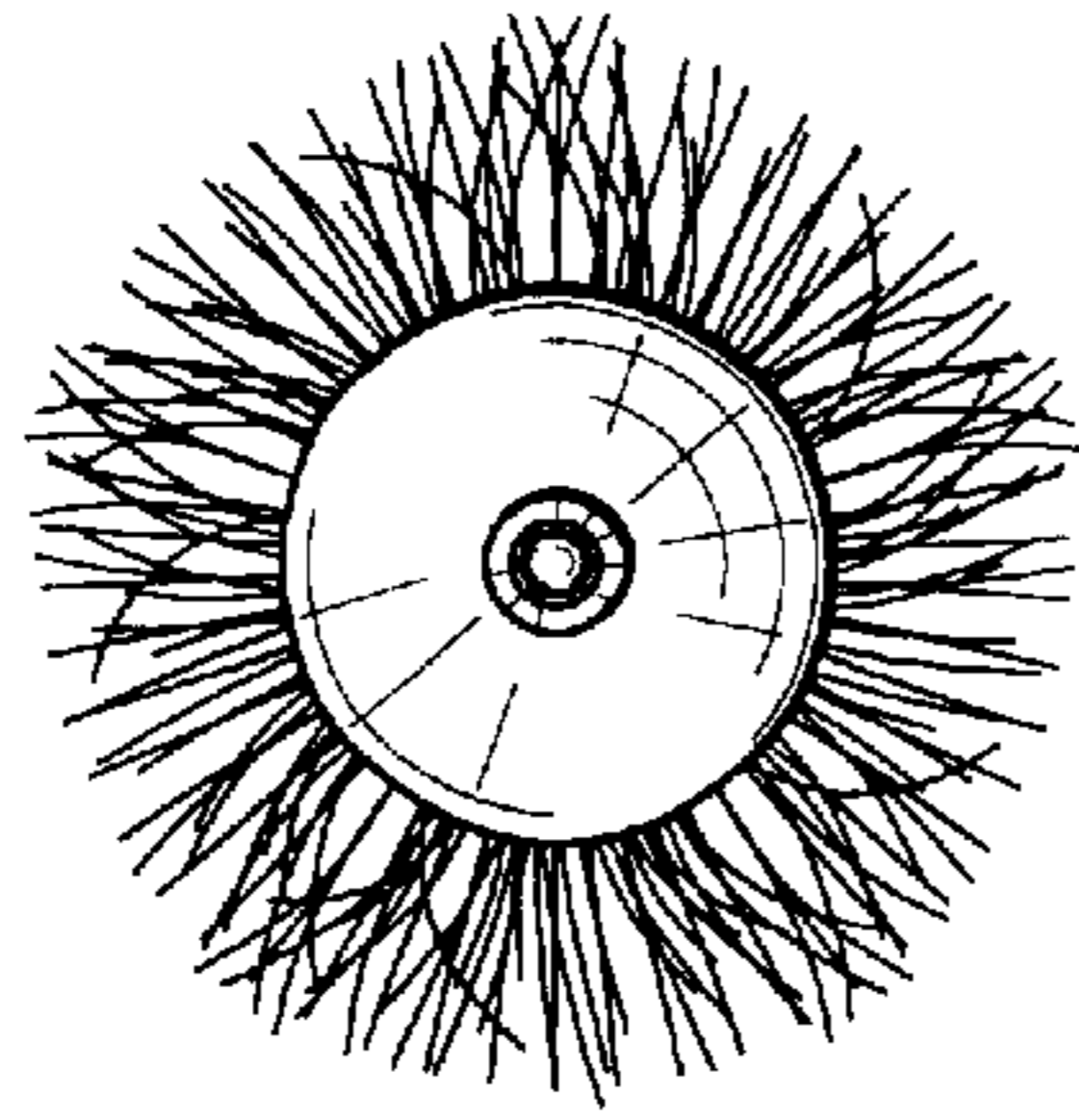

FIG. 9

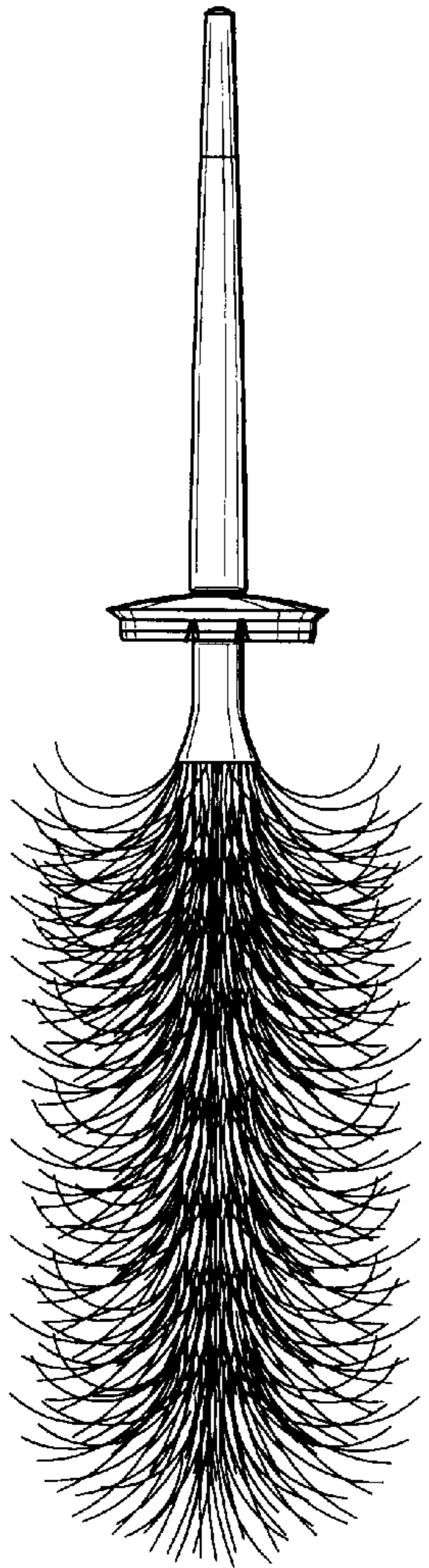

FIG. 8

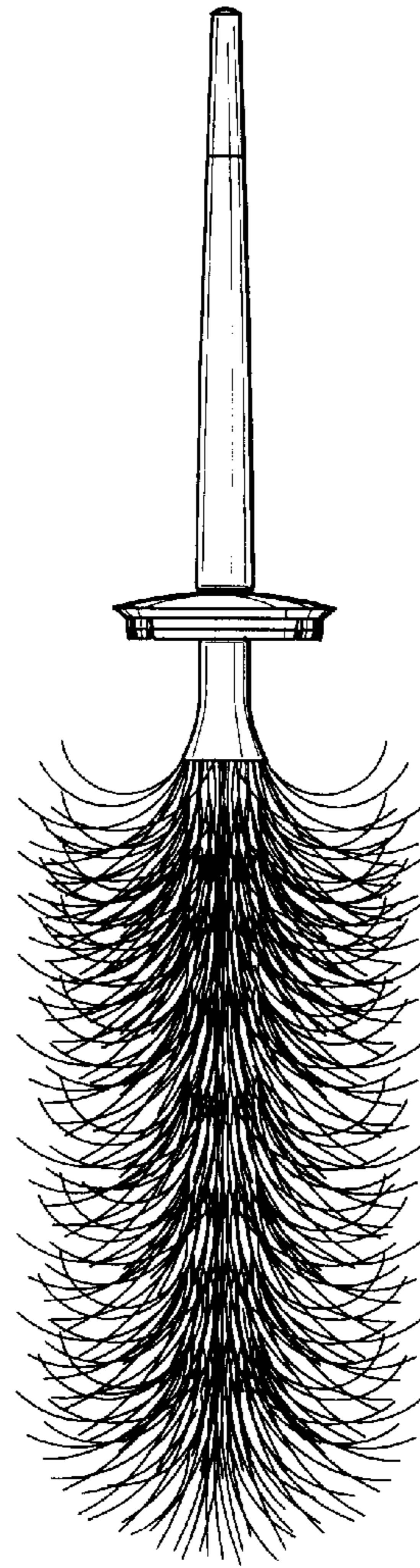

FIG. 11

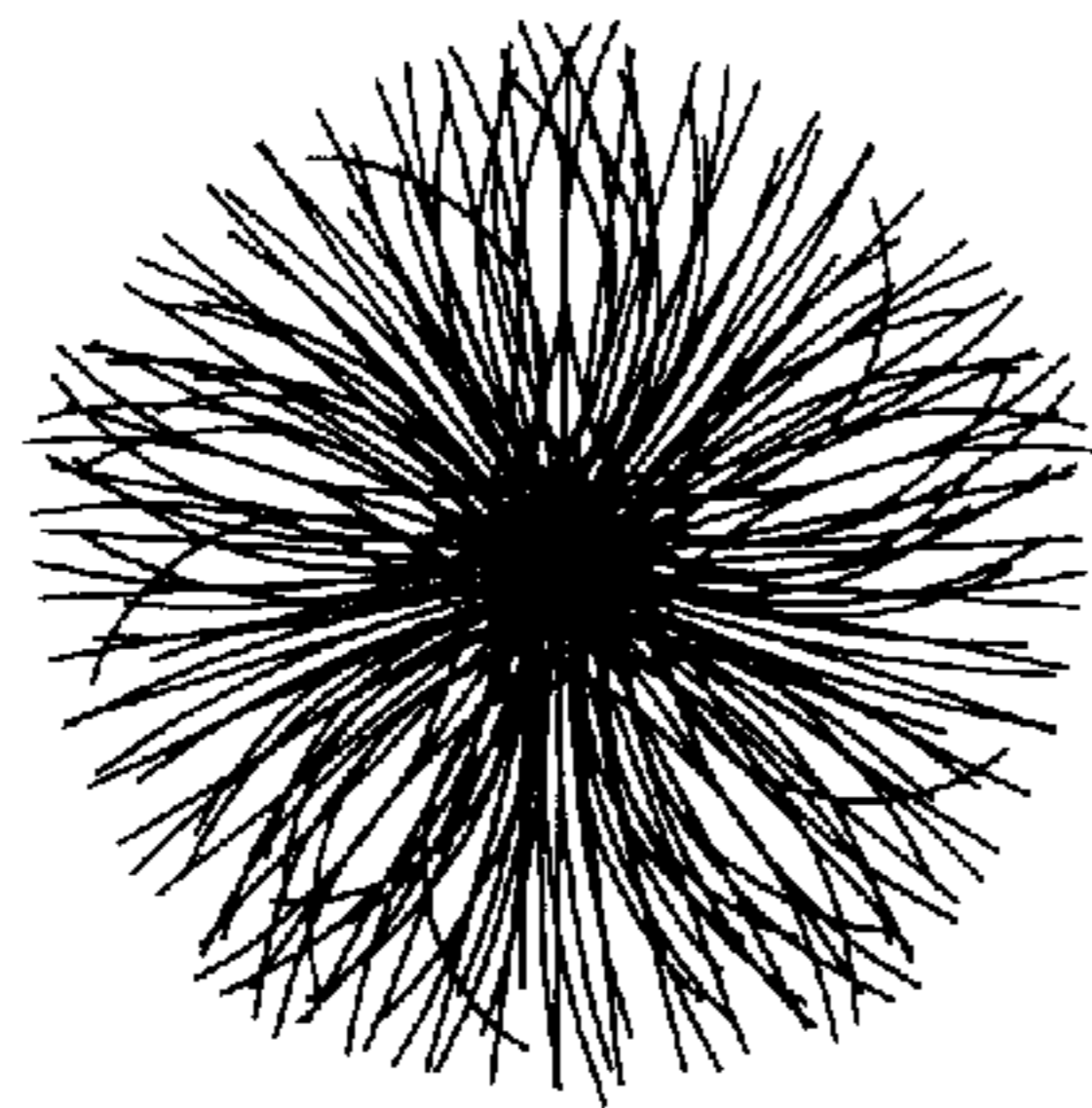

FIG. 10

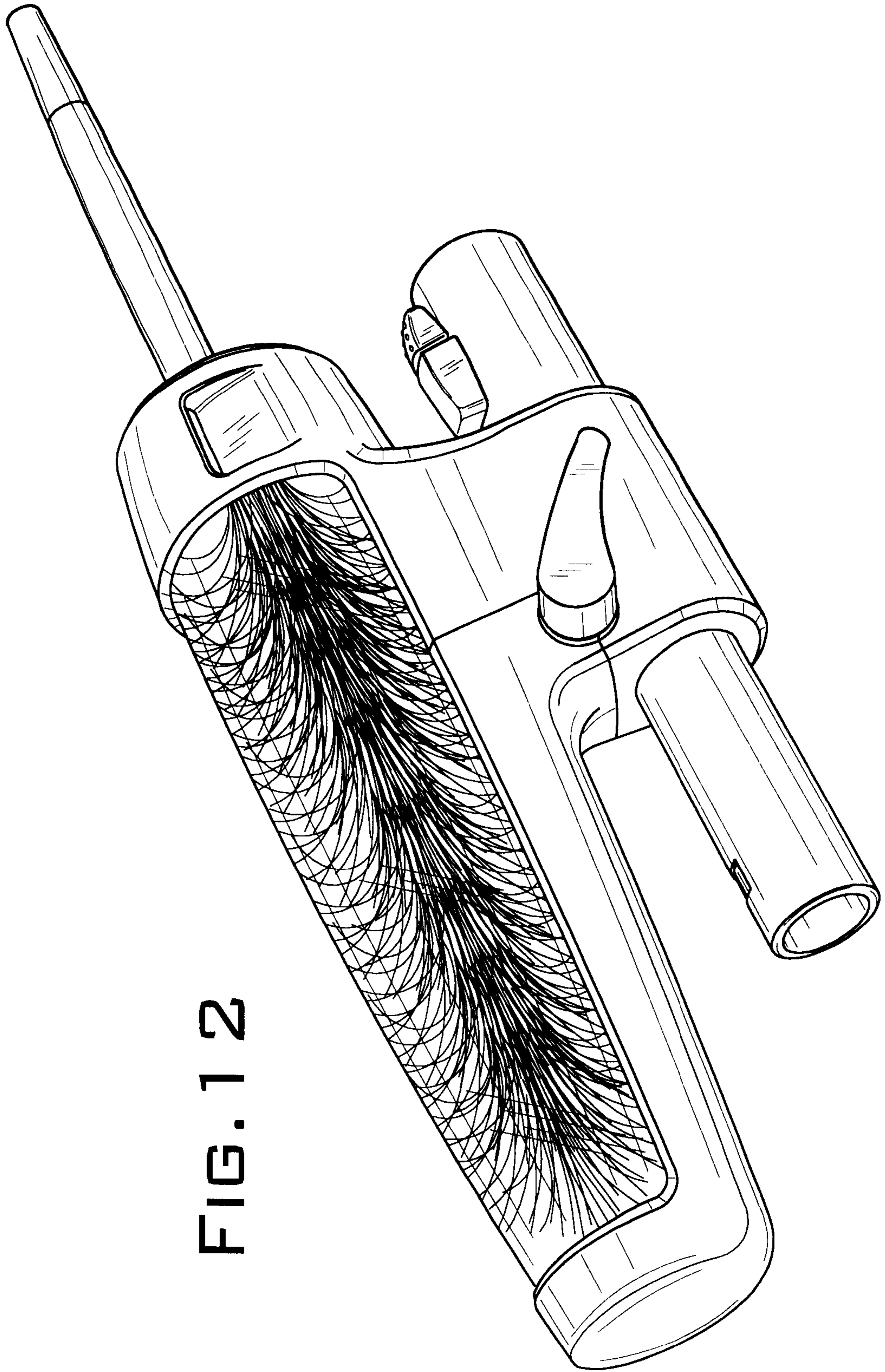

FIG. 12

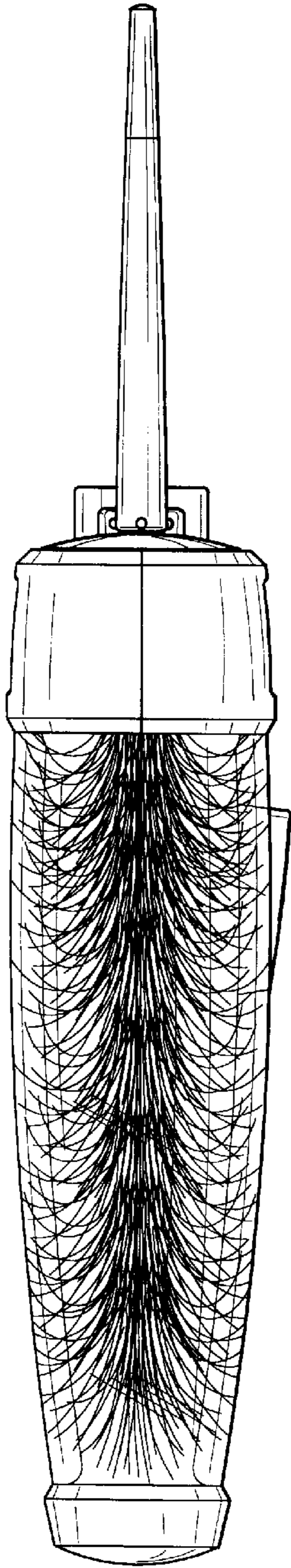

FIG. 14

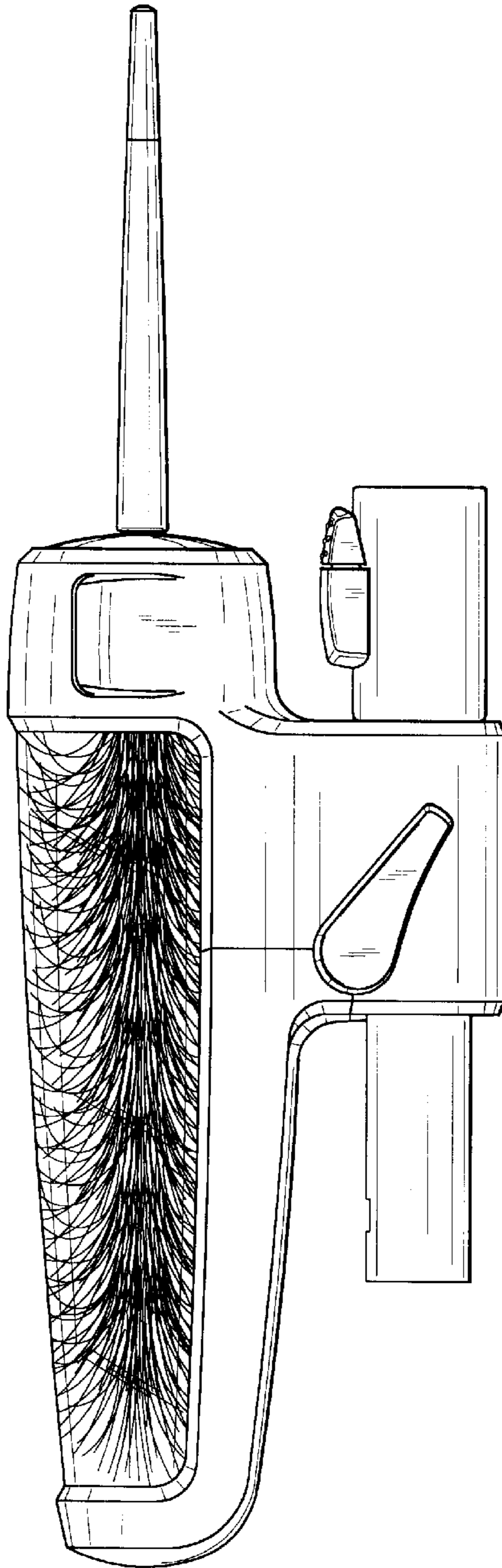

FIG. 13

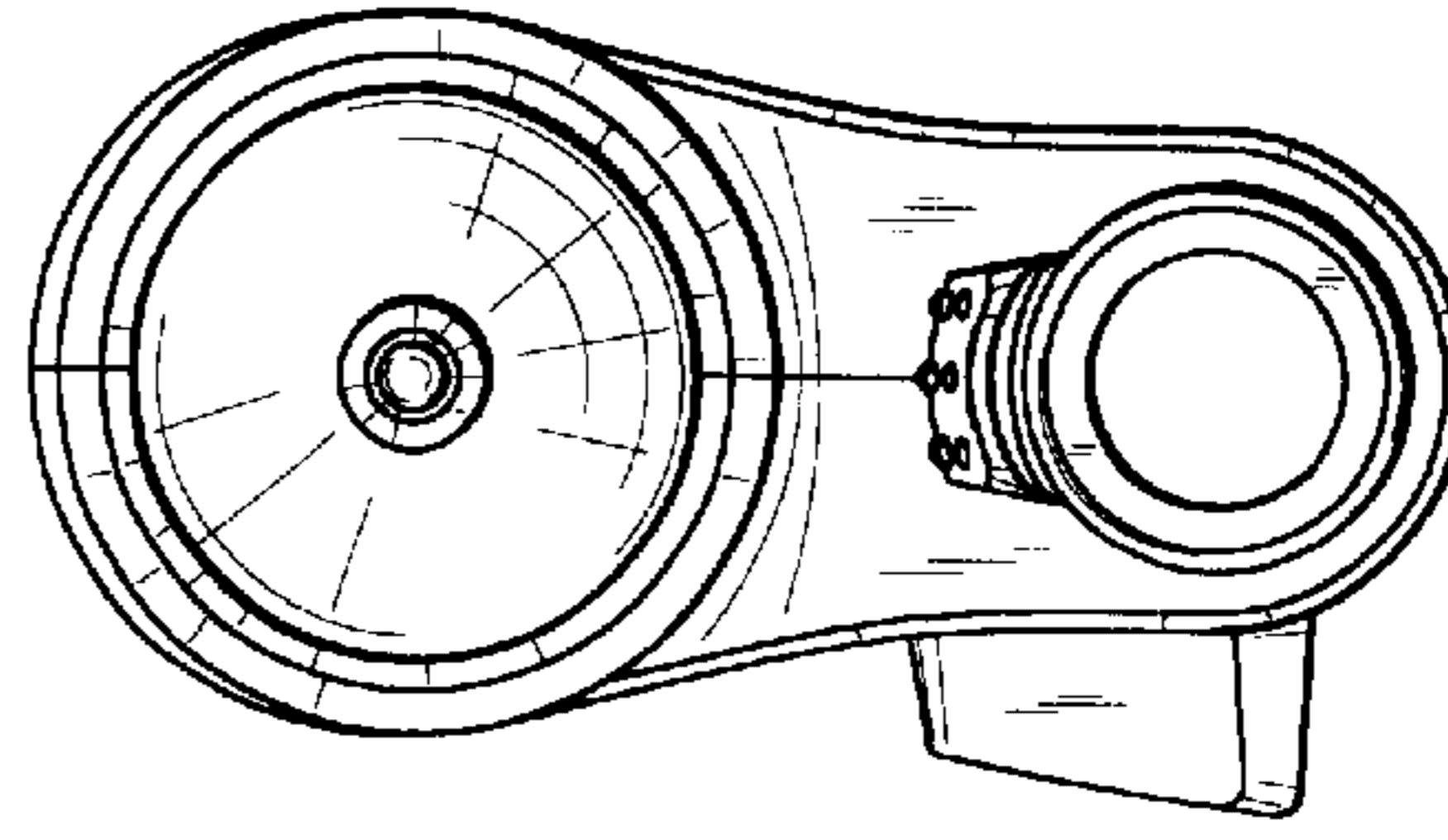

FIG. 15

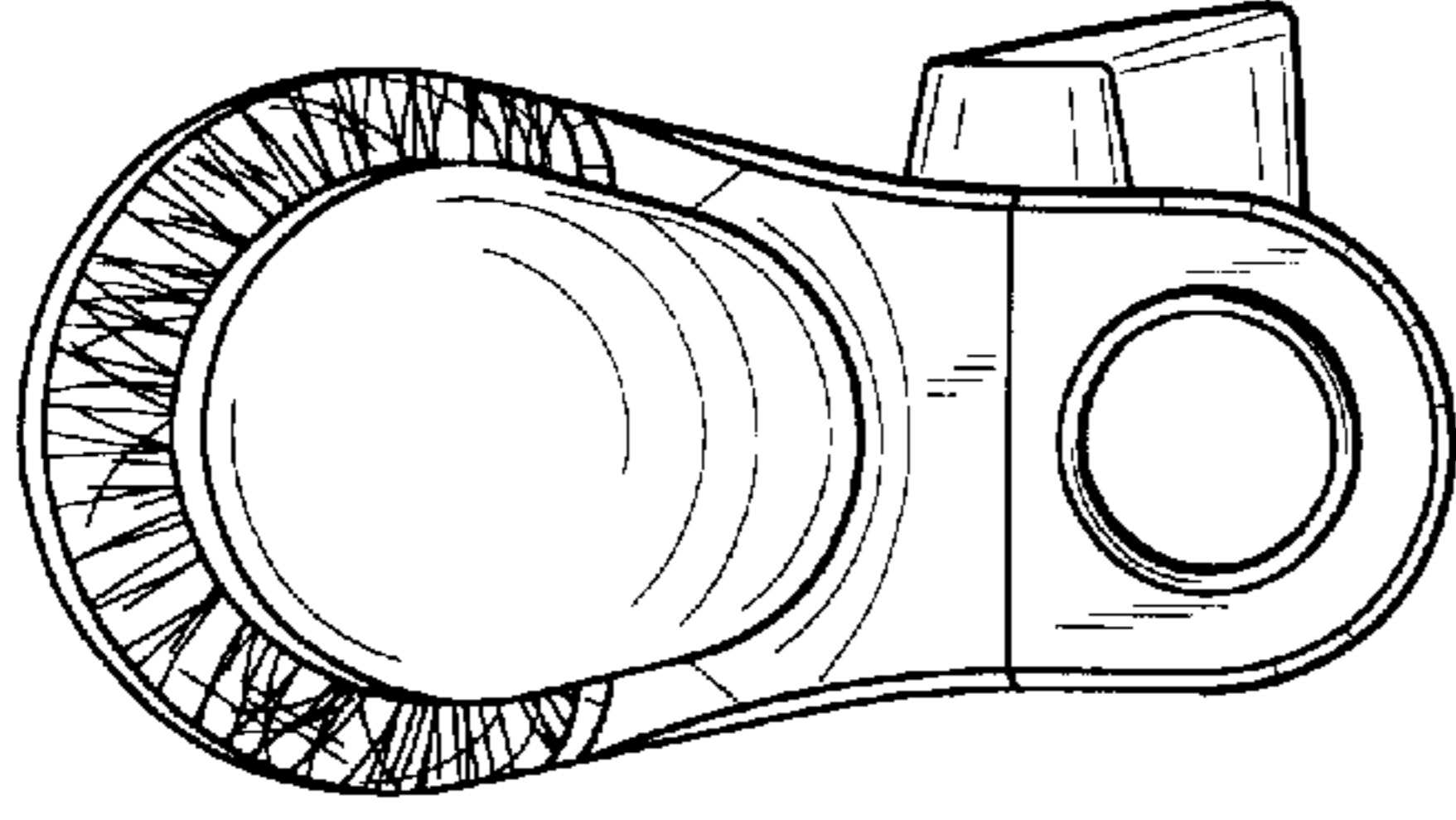

FIG. 17

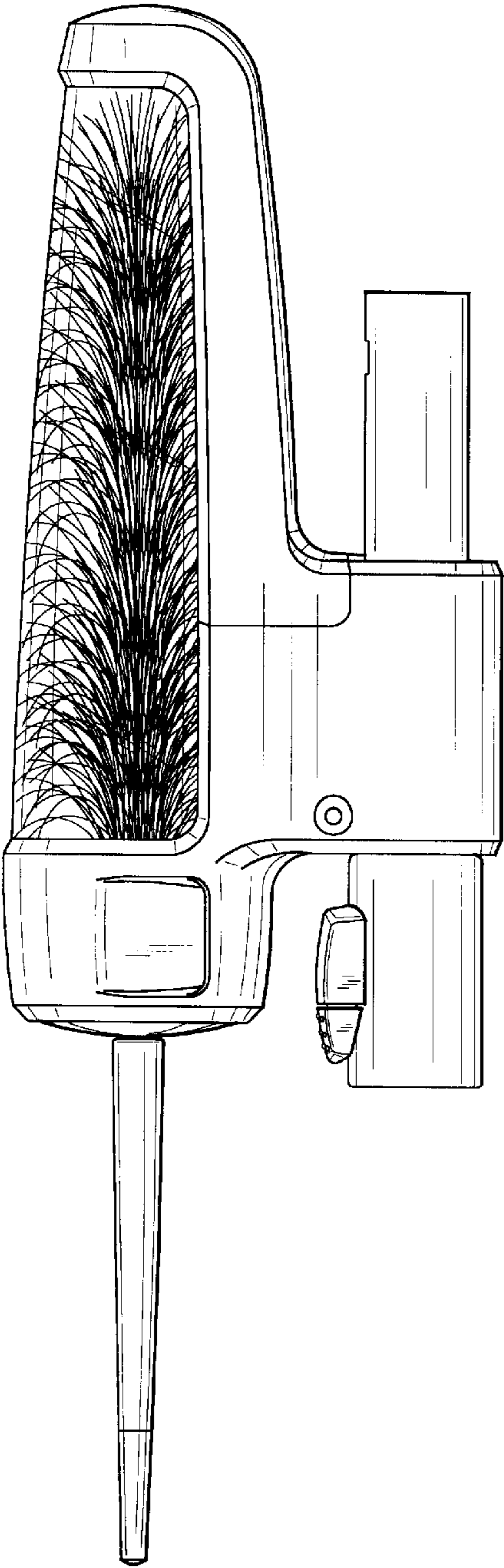

FIG. 16

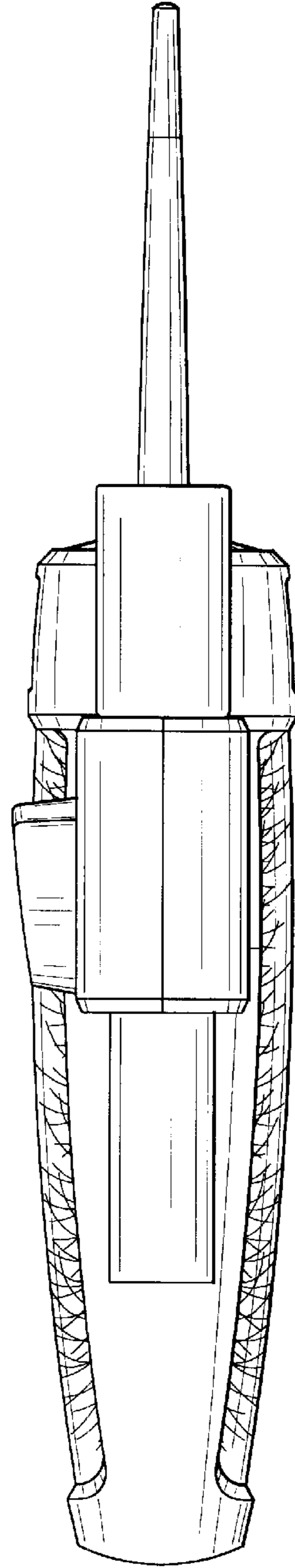

FIG. 18