



US00D487490S

(12) **United States Design Patent**  
**Evans**

(10) **Patent No.:** **US D487,490 S**

(45) **Date of Patent:** **\*\* Mar. 9, 2004**

(54) **ELEVATED DUMBBELL HOLDER**

(76) Inventor: **Steven Lee Evans**, 300 W. Magnolia St., Siloam Springs, AR (US) 72761

(\*\*) Term: **14 Years**

(21) Appl. No.: **29/161,714**

(22) Filed: **May 30, 2002**

(51) **LOC (7) Cl.** ..... **21-02**

(52) **U.S. Cl.** ..... **D21/686**

(58) **Field of Search** ..... D21/662, 686,  
D21/691, 694; 482/92, 93, 94, 139, 104,  
148

(56) **References Cited**

**U.S. PATENT DOCUMENTS**

4,205,838	A	*	6/1980	McIntosh	.....	482/106
4,666,150	A	*	5/1987	Segrist et al.	.....	482/104
5,411,459	A	*	5/1995	Hayden	.....	482/104
5,725,460	A	*	3/1998	Marsh	.....	482/104
5,924,964	A	*	7/1999	Hayden	.....	482/104
5,954,619	A	*	9/1999	Petrone	.....	482/104
D415,223	S	*	10/1999	Gay	.....	D21/686
5,971,898	A	*	10/1999	Schoolfield	.....	482/104
D425,152	S	*	5/2000	Ceppo	.....	D21/686
D453,542	S	*	2/2002	Louiso	.....	D21/694

\* cited by examiner

*Primary Examiner*—Philip S. Hyder

(74) *Attorney, Agent, or Firm*—Keisling & Pieper PLC; Trent C. Keisling; David B. Pieper

(57) **CLAIM**

The ornamental design for an elevated dumbbell holder showing my new design.

**DESCRIPTION**

FIG. 1 is a perspective view of an elevated dumbbell holder showing my new design, wherein the broken line showing of the environmental structure is for illustrative purposes only and forms no part of the claimed design.

FIG. 2 is a perspective view thereof;

FIG. 3 is a perspective view thereof, taken generally from the opposite side of FIG. 2;

FIG. 4 is a perspective view thereof, taken generally oppositely to FIG. 2;

FIG. 5 is a perspective view thereof, taken generally from the opposite side of FIG. 4;

FIG. 6 is a top plan view thereof;

FIG. 7 is a front elevational view with the opposite side being a mirror image thereof;

FIG. 8 is a side elevational view with the opposite side being a mirror image thereof; and,

FIG. 9 is a bottom plan view thereof.

**1 Claim, 3 Drawing Sheets**

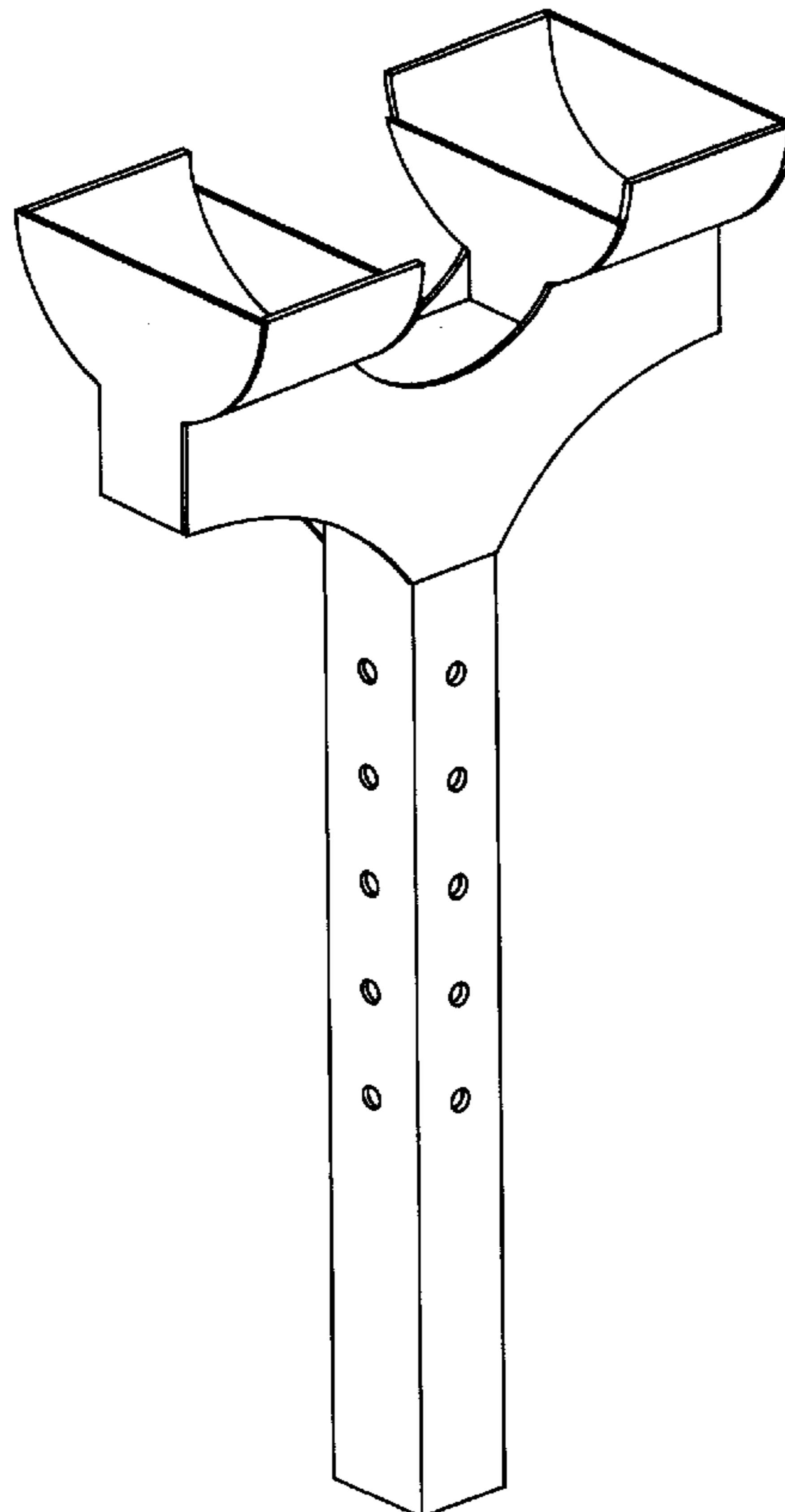

FIG. 1

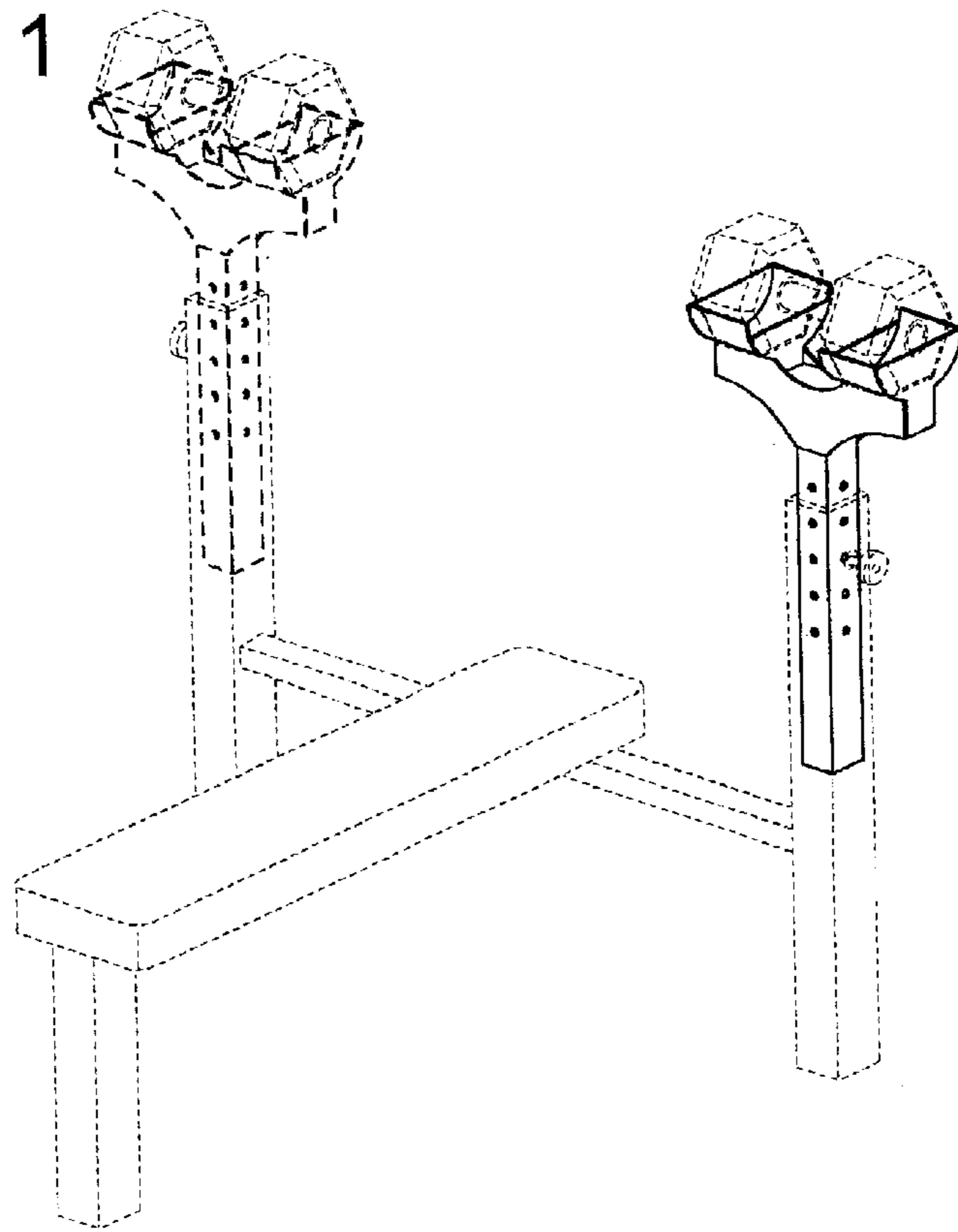

FIG. 2

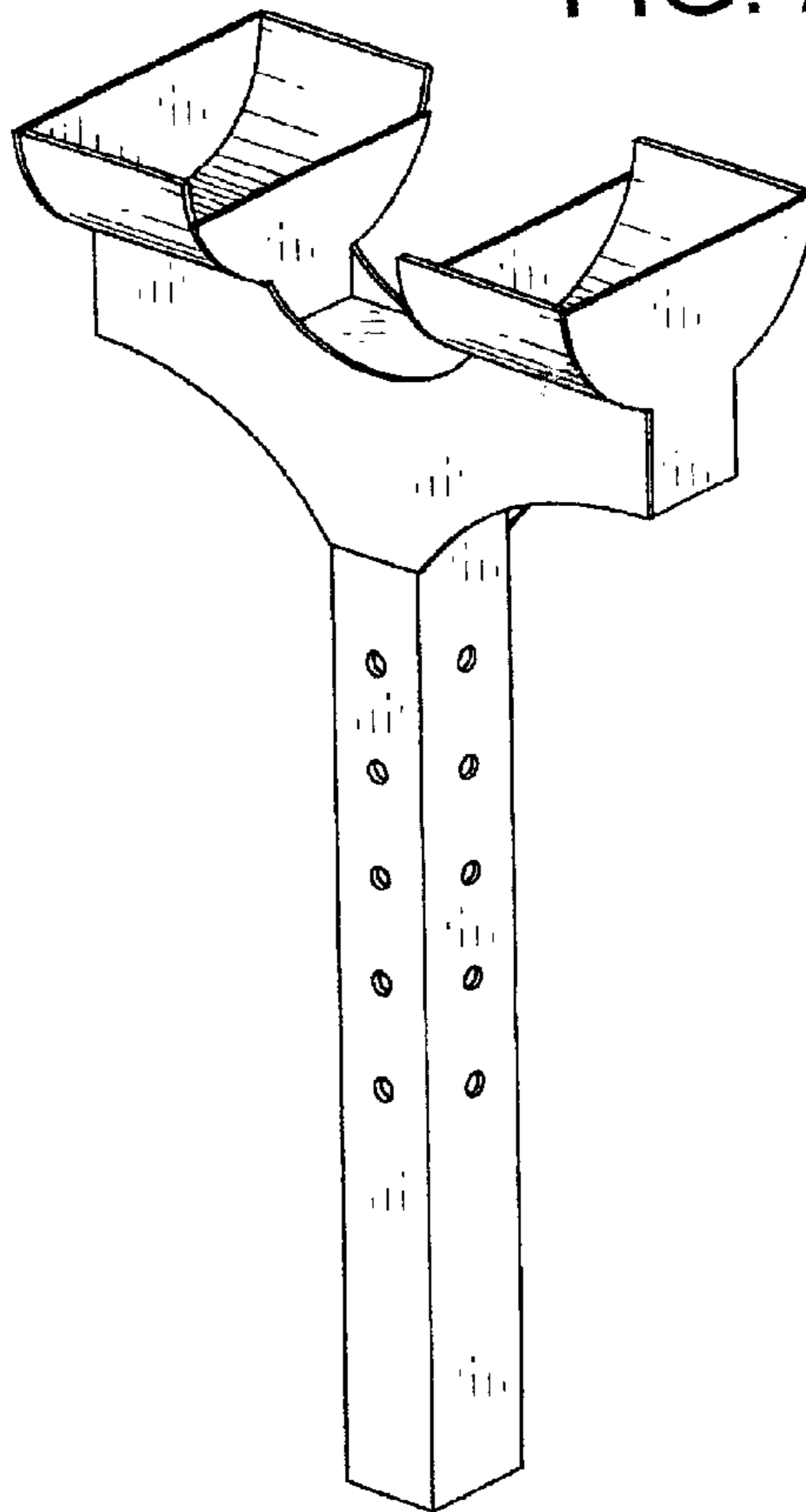

FIG. 3

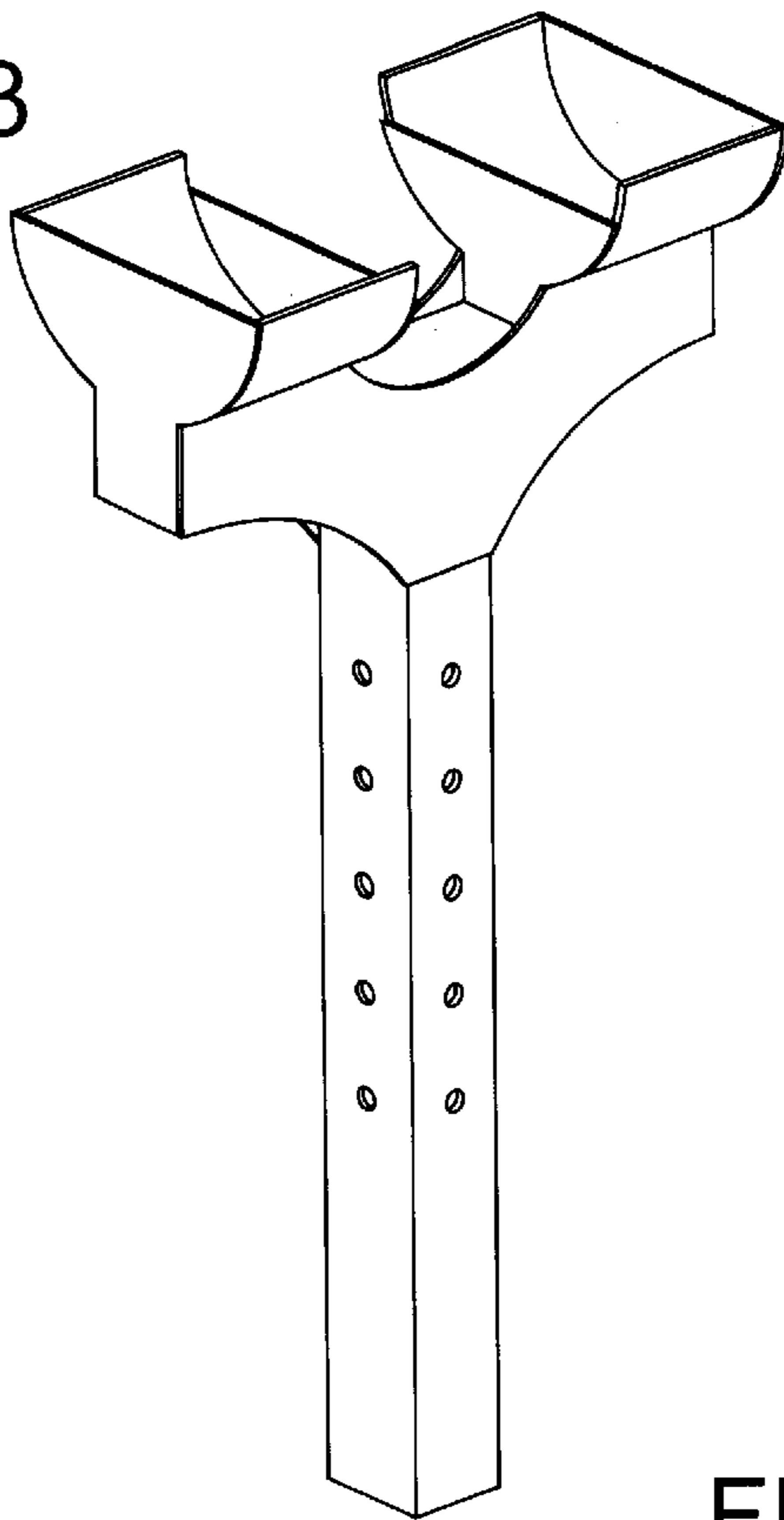

FIG. 4

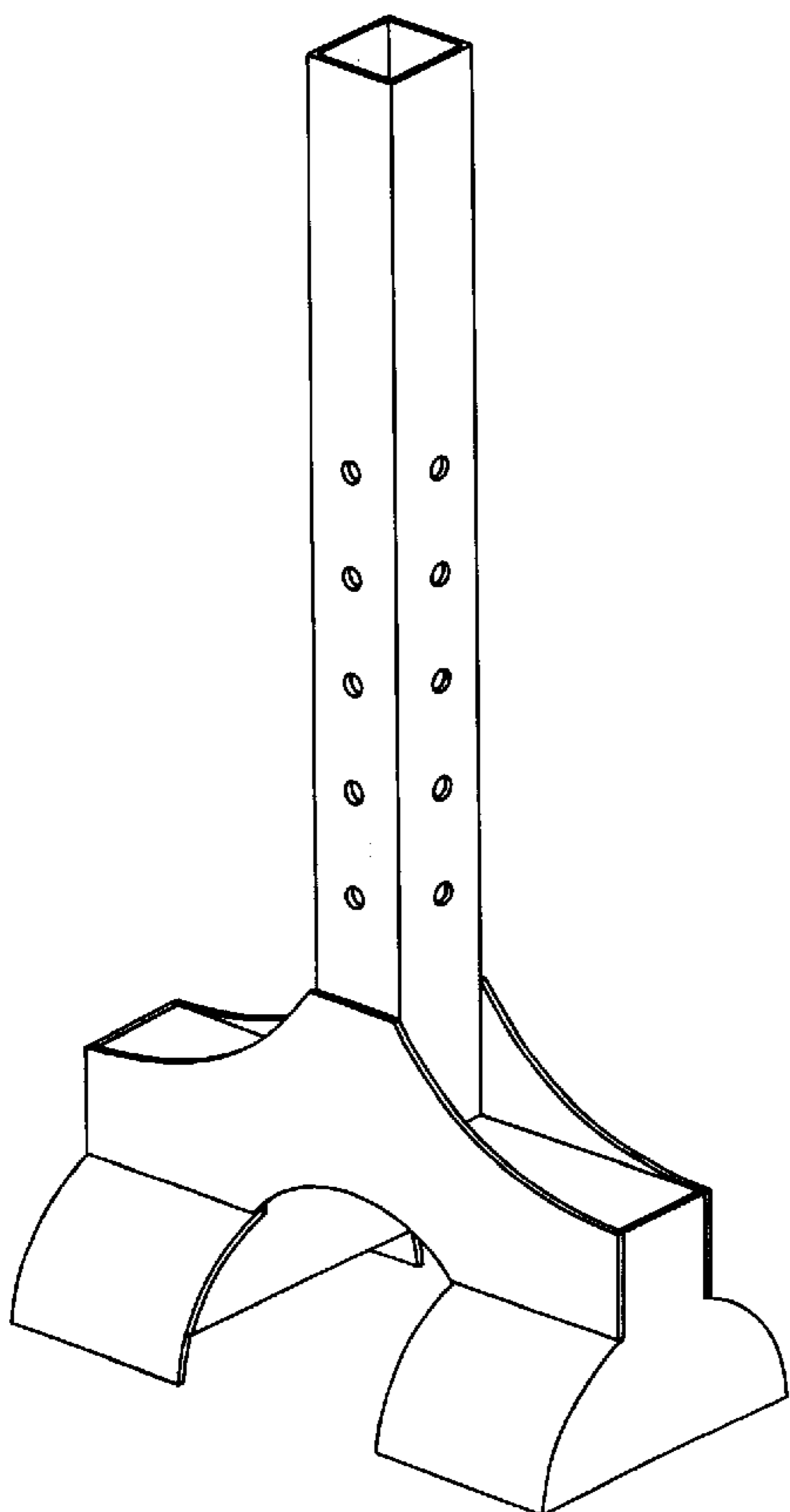

FIG. 5

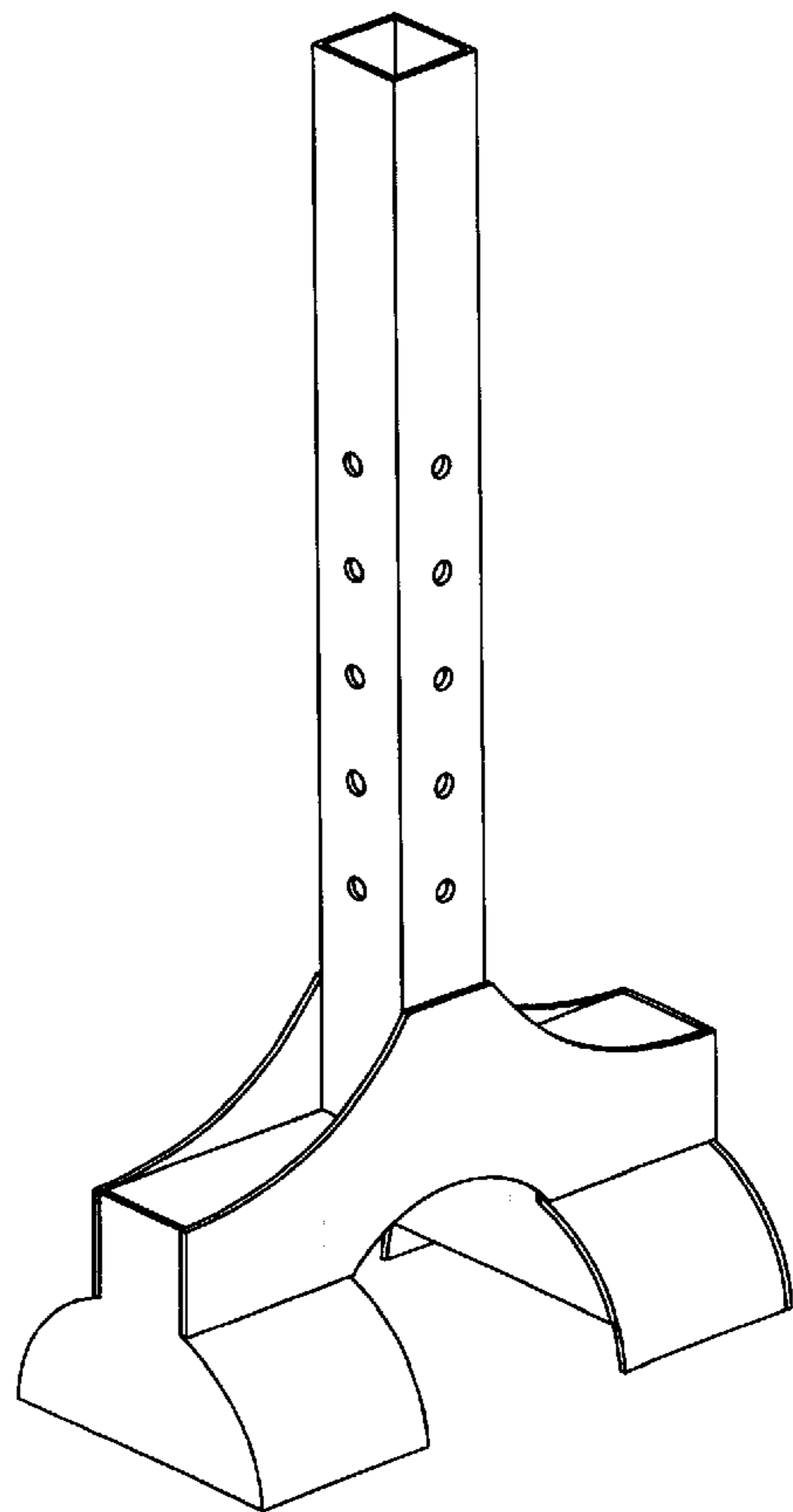

FIG. 6

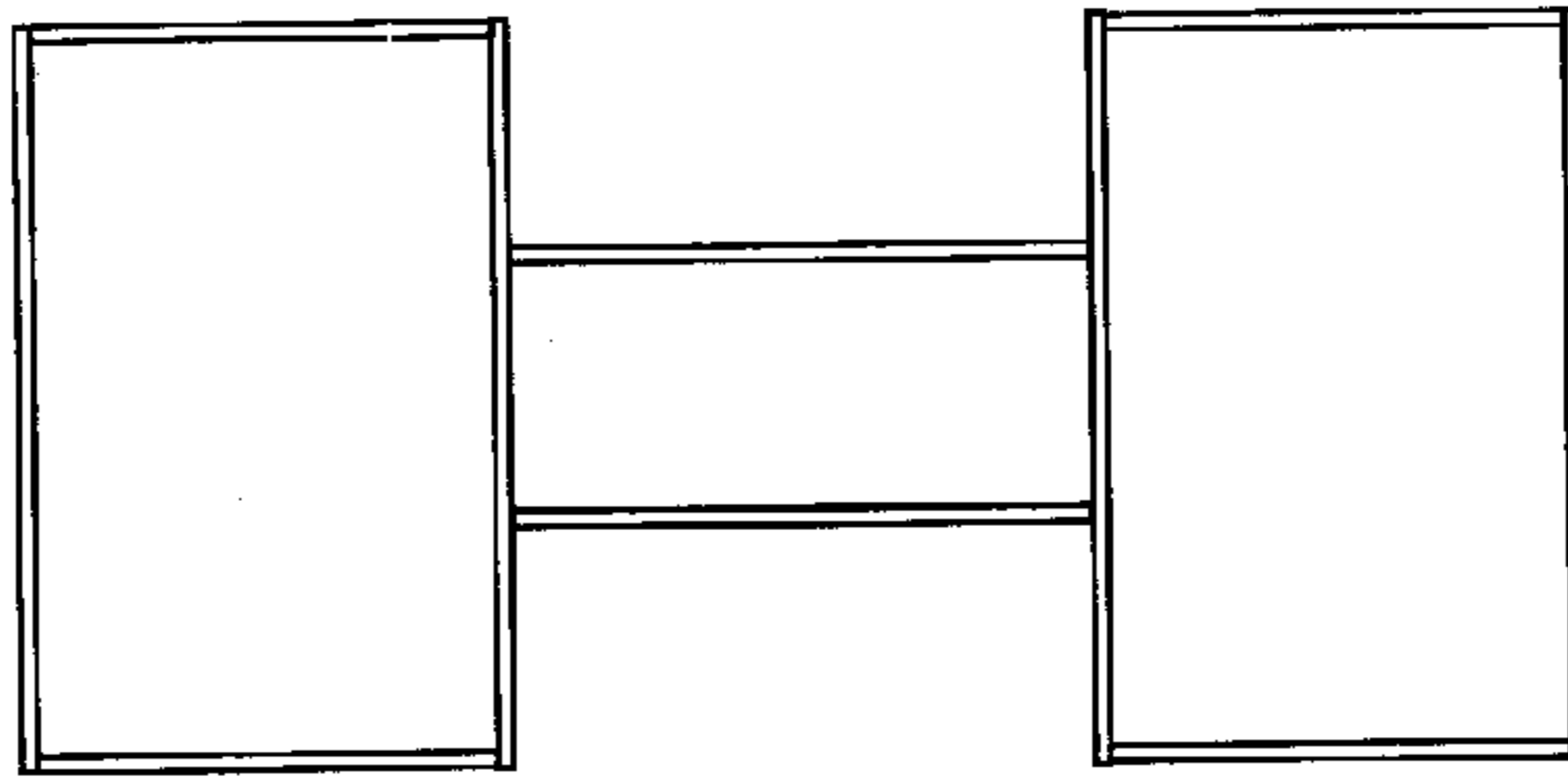

FIG. 7

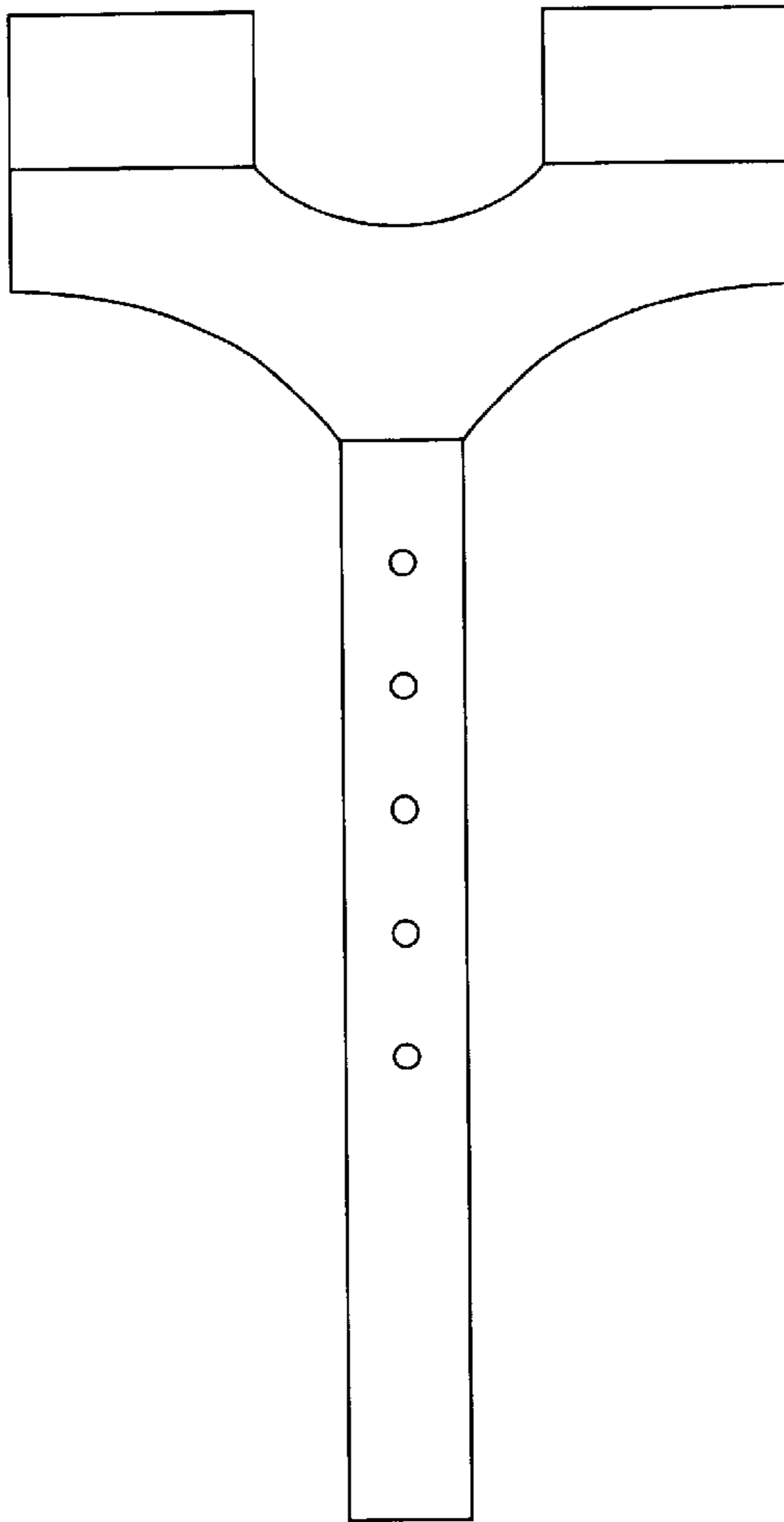

FIG. 8

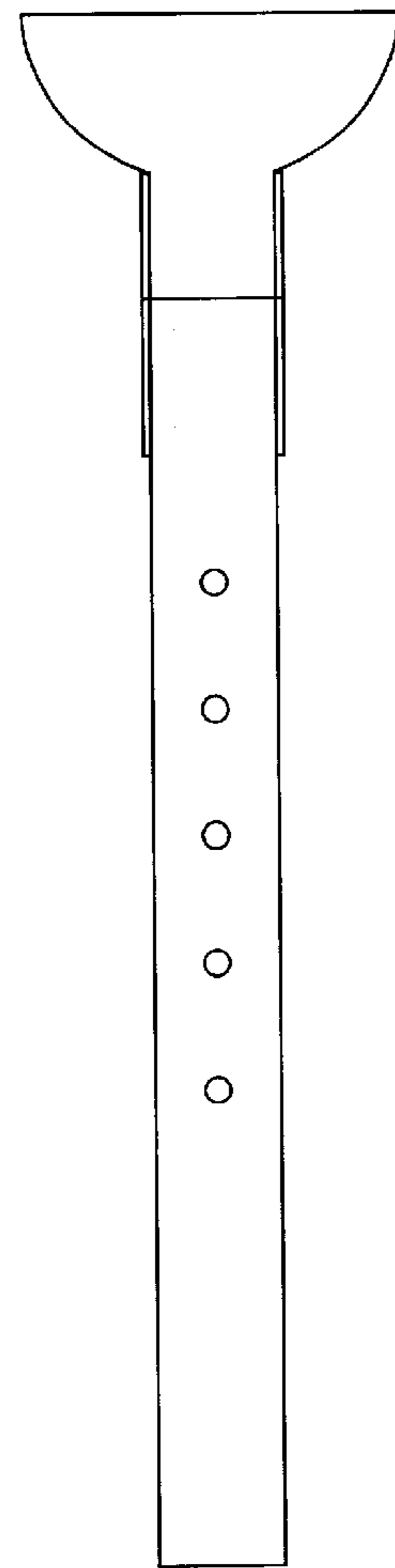

FIG. 9

