



US00D487267S

(12) **United States Design Patent**
Wei

(10) **Patent No.:** **US D487,267 S**

(45) **Date of Patent:** **** Mar. 2, 2004**

(54) **KEYBOARD**

(75) **Inventor:** **Tzu-Hao Wei**, Hacienda Heights, CA (US)

(73) **Assignee:** **Hon Hai Precision Ind. Co., Ltd.**, Taipei Hsiena (TW)

(**) **Term:** **14 Years**

(21) **Appl. No.:** **29/172,965**

(22) **Filed:** **Dec. 18, 2002**

(51) **LOC (7) Cl.** **14-02**

(52) **U.S. Cl.** **D14/396**

(58) **Field of Search** D14/391, 392, D14/396, 398; D18/1, 2, 7; 178/17 A, 17 C; 200/5 A, 5 R, 6 A, 6 R; 235/145 A, 145 R; 341/22, 23; 345/160, 168; 400/484-488, 489, 492

(56) **References Cited**

U.S. PATENT DOCUMENTS

D376,592 S * 12/1996 Tsai D14/398

D385,264 S * 10/1997 Schindler et al. D14/398
D439,903 S * 4/2001 Kaneko et al. D14/396
D443,271 S * 6/2001 Poole et al. D14/392

* cited by examiner

Primary Examiner—Freda Nunn

(74) *Attorney, Agent, or Firm*—Wei Te Chung

(57) **CLAIM**

The ornamental design for a keyboard, as shown.

DESCRIPTION

FIG. 1 is a perspective view of a keyboard of my new design;
FIG. 2 is a front elevational view thereof;
FIG. 3 is a rear elevational view thereof;
FIG. 4 is a left side elevational view thereof;
FIG. 5 is a right side elevational view thereof;
FIG. 6 is a top plan view thereof; and,
FIG. 7 is a bottom plan view thereof.

1 Claim, 5 Drawing Sheets

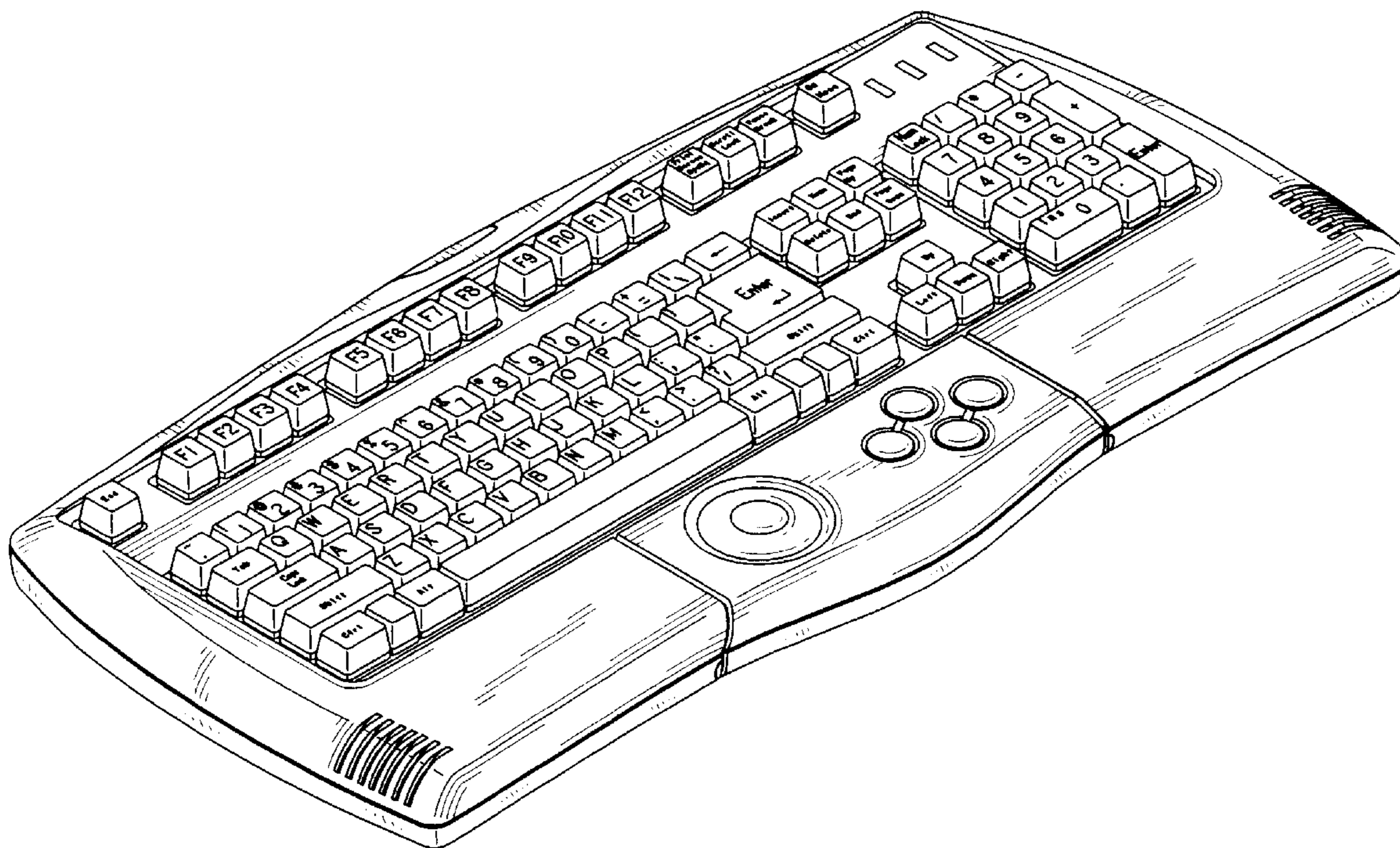

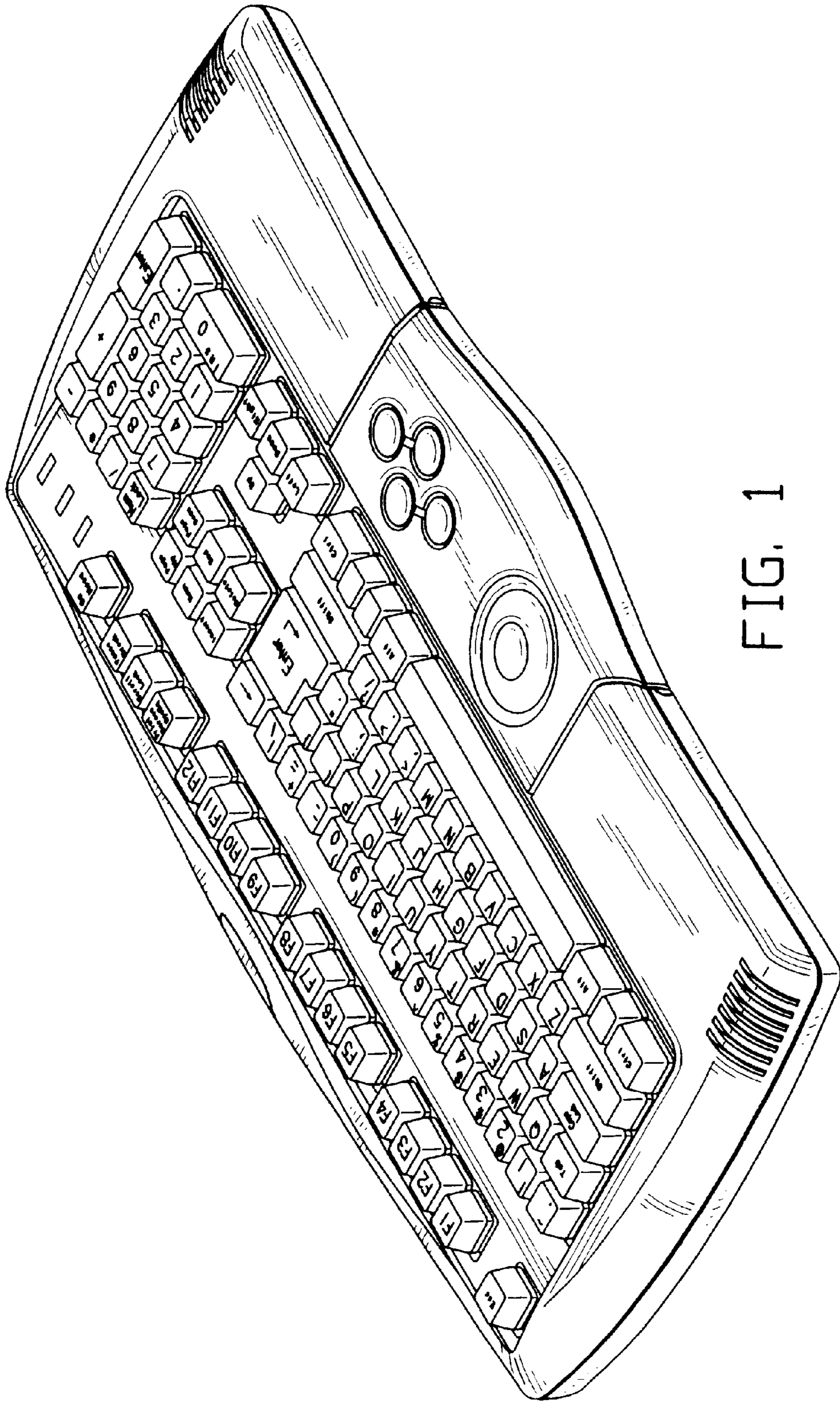

FIG. 1



FIG. 2

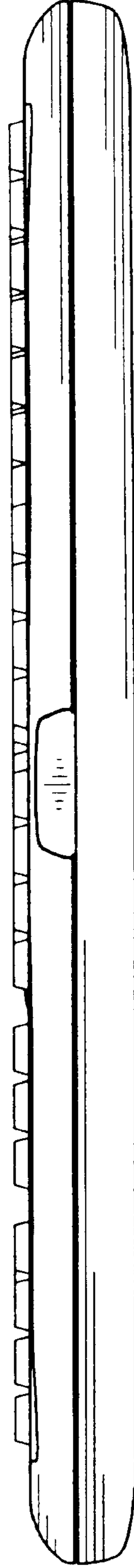

FIG. 3

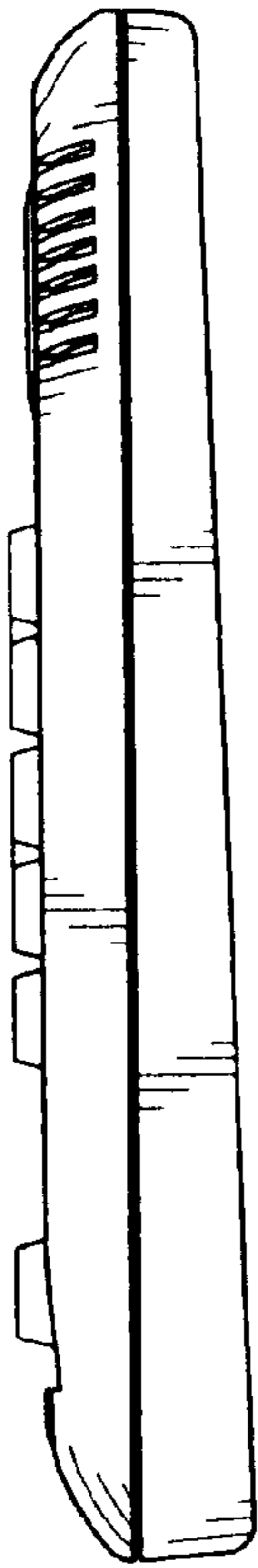

FIG. 4

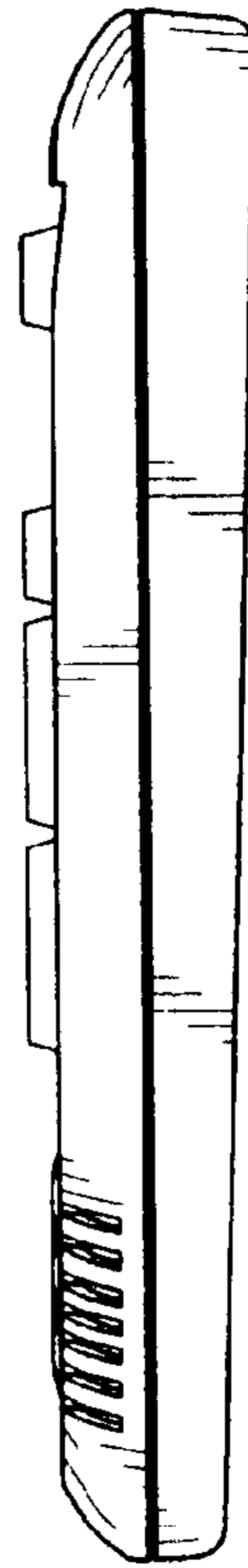

FIG. 5

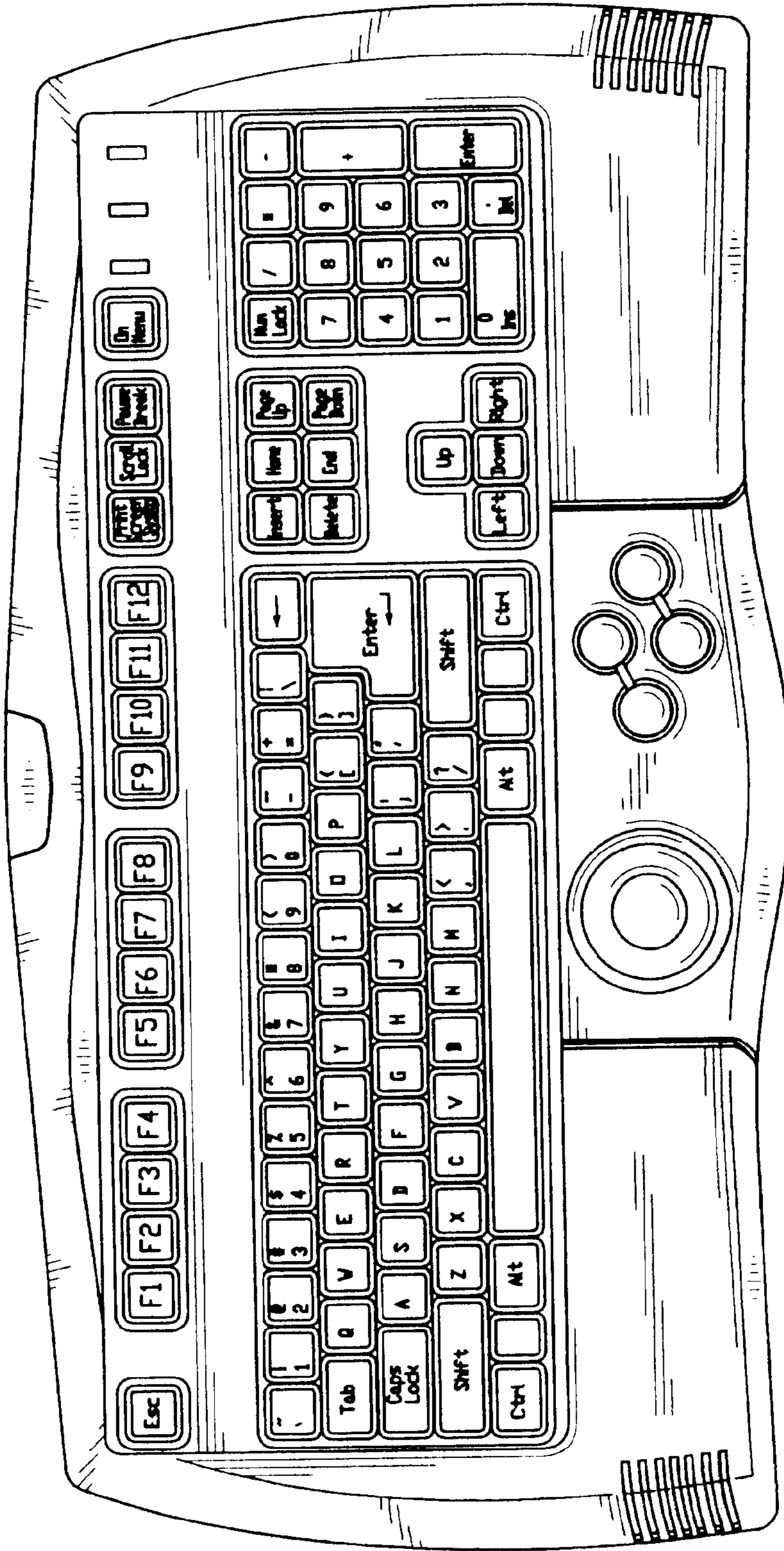

FIG. 6

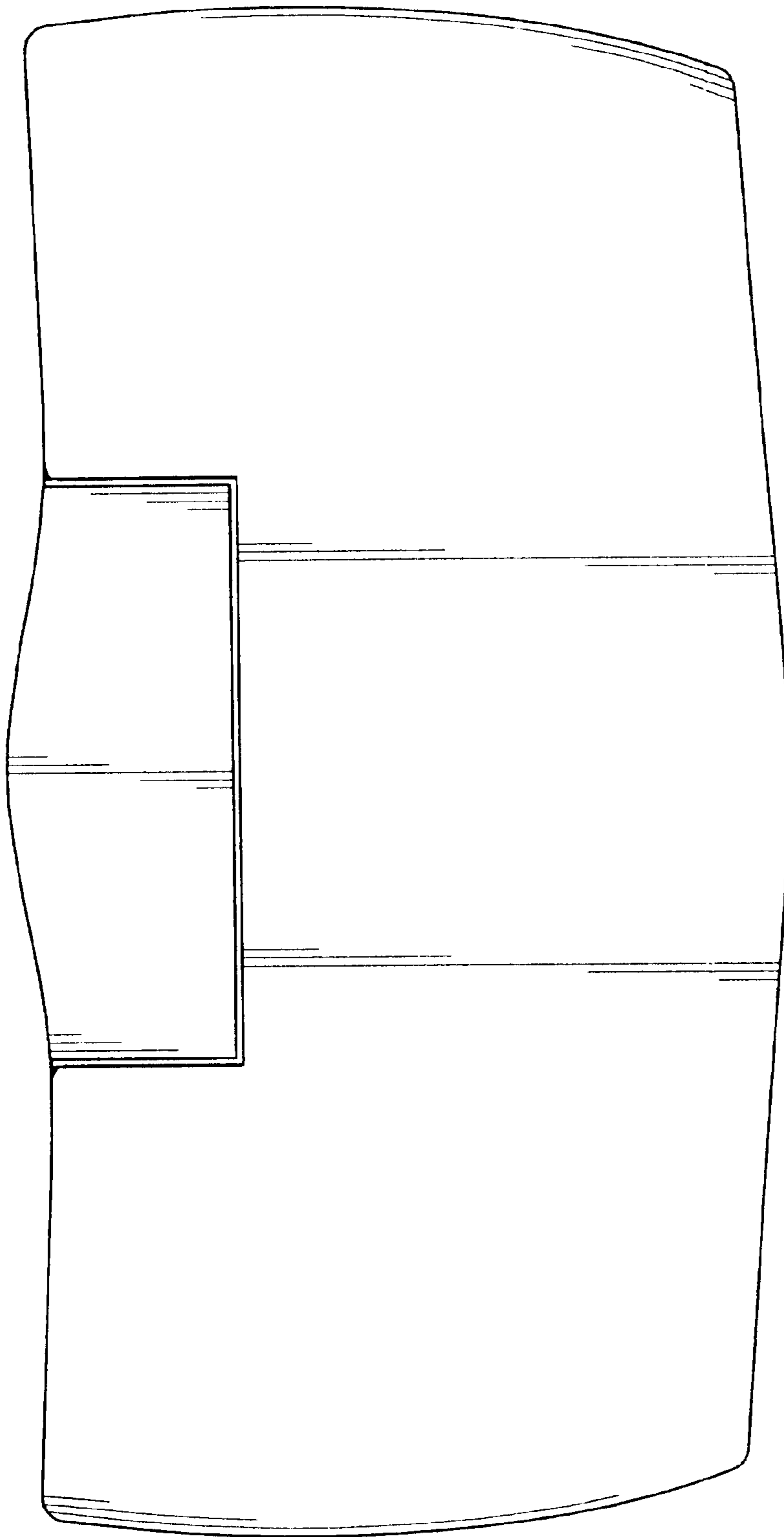

FIG. 7