



US00D487259S

(12) **United States Design Patent**
Obata

(10) **Patent No.:** **US D487,259 S**

(45) **Date of Patent:** **** Mar. 2, 2004**

(54) **DIGITAL VOICE RECORDER**

JP 1117605 S 6/2001
JP 1123367 S 8/2001
JP 1132171 S 11/2001

(75) Inventor: **Yasushi Obata**, Osaka (JP)

* cited by examiner

(73) Assignees: **Sanyo Electric Co., Ltd.**, Moriguchi (JP); **Sanyo Technosound Co., Ltd.**, Daito (JP)

Primary Examiner—Nanda Bondade
(74) *Attorney, Agent, or Firm*—Darby & Darby

(**) Term: **14 Years**

(57) **CLAIM**

(21) Appl. No.: **29/171,382**

The ornamental design for a digital voice recorder, as shown and described.

(22) Filed: **Nov. 21, 2002**

DESCRIPTION

(30) **Foreign Application Priority Data**

May 28, 2002 (JP) 2002-014258

(51) **LOC (7) Cl.** **14-01**

(52) **U.S. Cl.** **D14/167**

(58) **Field of Search** D14/160–165,
D14/167–168, 188, 192–198, 217–218,
299, 496; 455/344, 347–351

FIG. 1 is a top, front, and right side perspective view of my new design for a digital voice recorder in the open position; FIG. 2 is a front elevation view thereof; FIG. 3 is a rear elevation view thereof; FIG. 4 is a top plan view thereof; FIG. 5 is a bottom plan view thereof; FIG. 6 is a left side elevation view thereof; FIG. 7 is a right side elevation view thereof; FIG. 8 is a front elevation view thereof in the closed position; FIG. 9 is a right side elevation view thereof in the closed position; FIG. 10 is a rear elevation view thereof in the closed position; and, FIG. 11 is a top, front and right side perspective view thereof shown attached to a laptop computer.

(56) **References Cited**

U.S. PATENT DOCUMENTS

D426,223 S * 6/2000 Nomura D14/167
D427,176 S * 6/2000 Obata D14/167
D436,941 S * 1/2001 Kataoka D14/165
D463,393 S * 9/2002 Kataoka D14/167

The broken line showing of laptop computer on FIG. 11 is for illustrative purposes only and forms no part of the claimed design.

FOREIGN PATENT DOCUMENTS

JP 1042720 S 6/1999
JP 1105746 S 2/2001
JP 1105747 S 2/2001

1 Claim, 5 Drawing Sheets

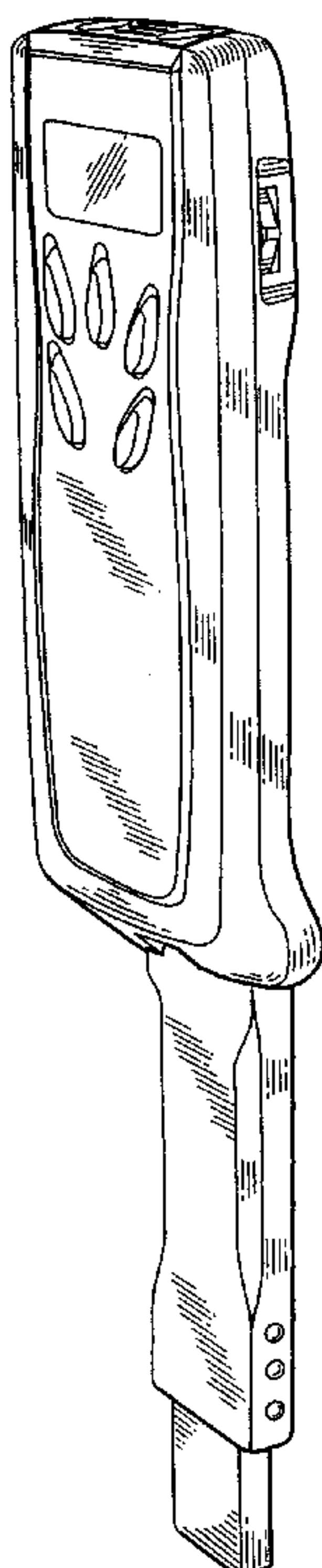

FIG.1

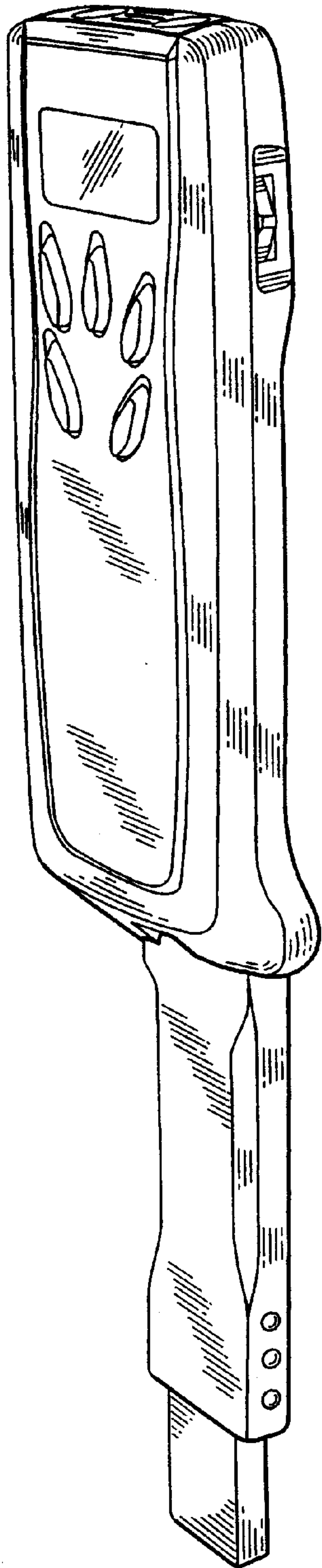

FIG.2

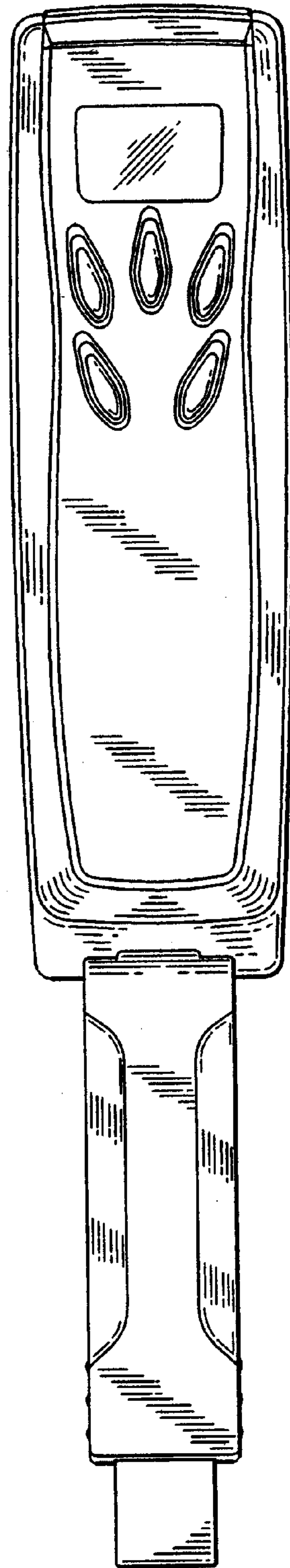

FIG.3

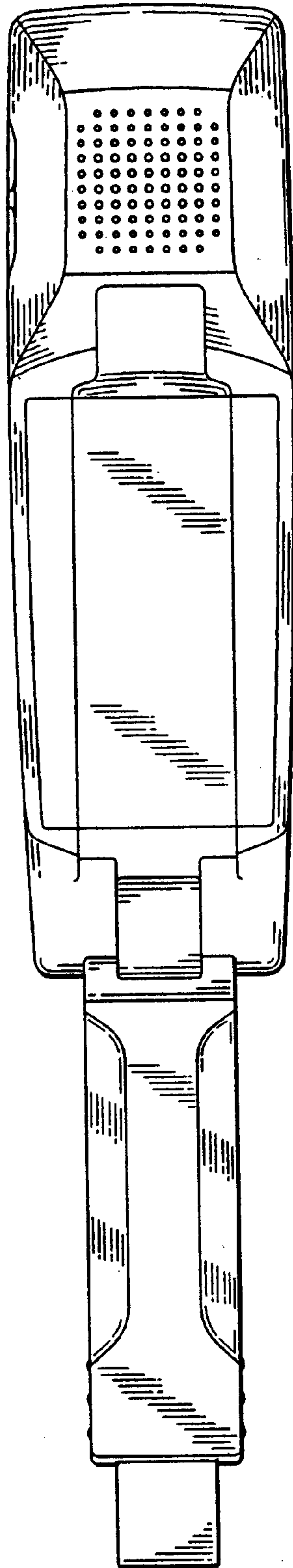

FIG.4

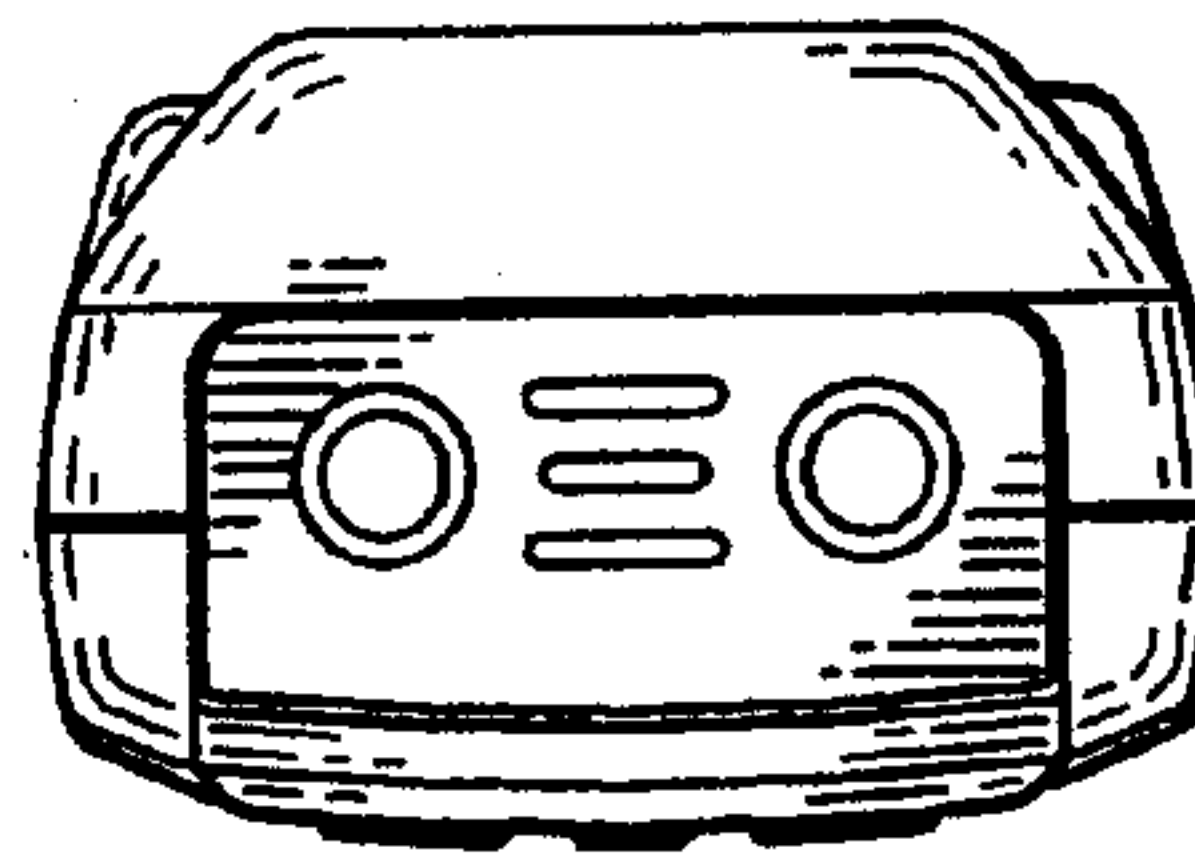

FIG.5

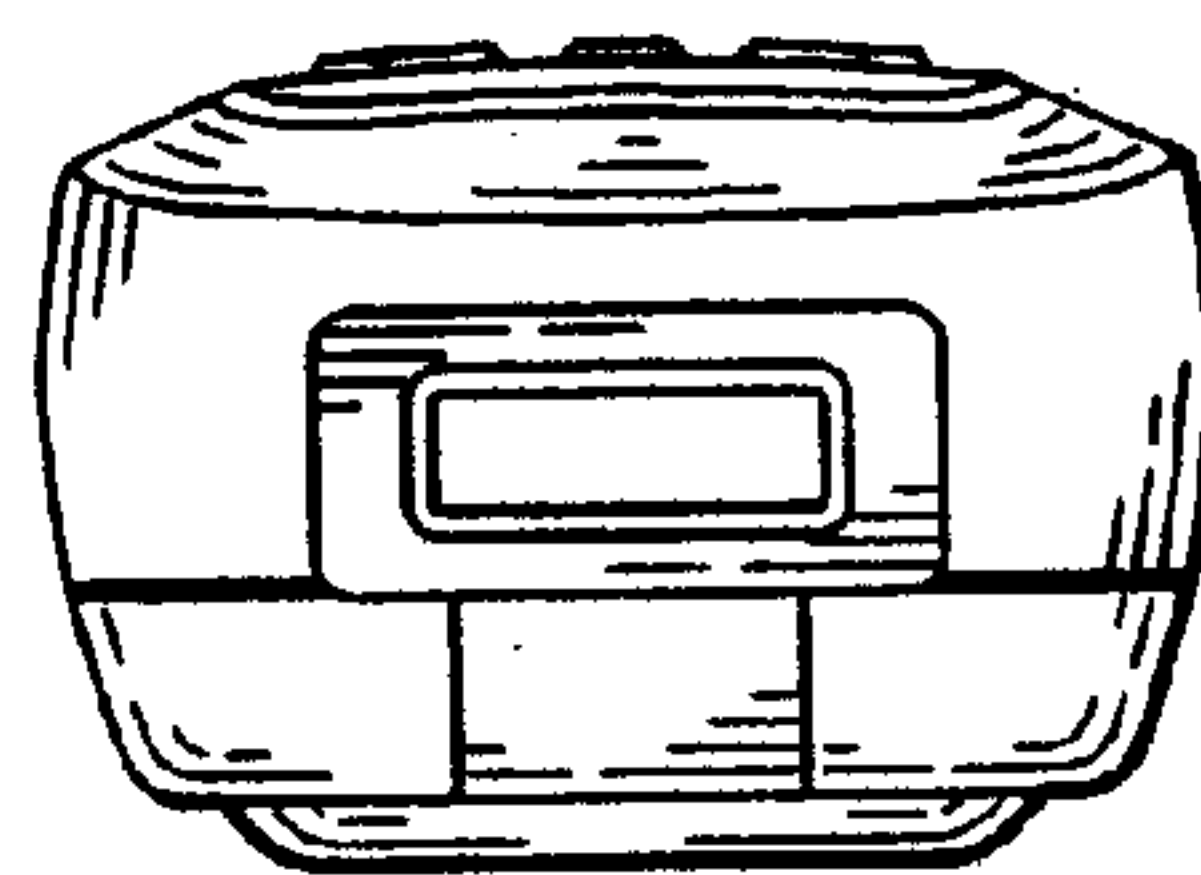

FIG.6

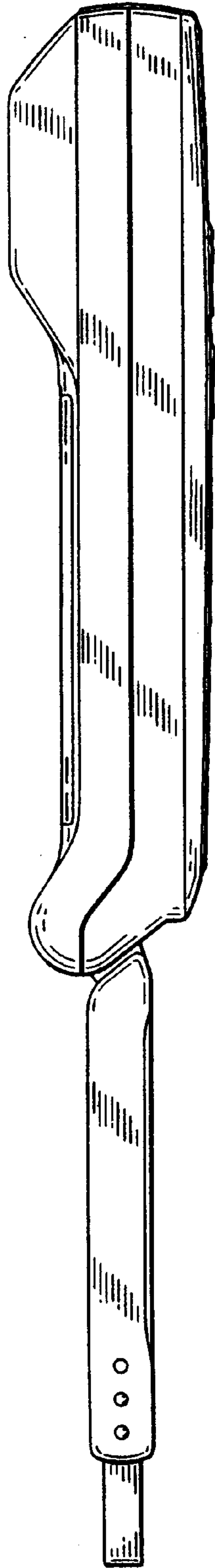

FIG.7

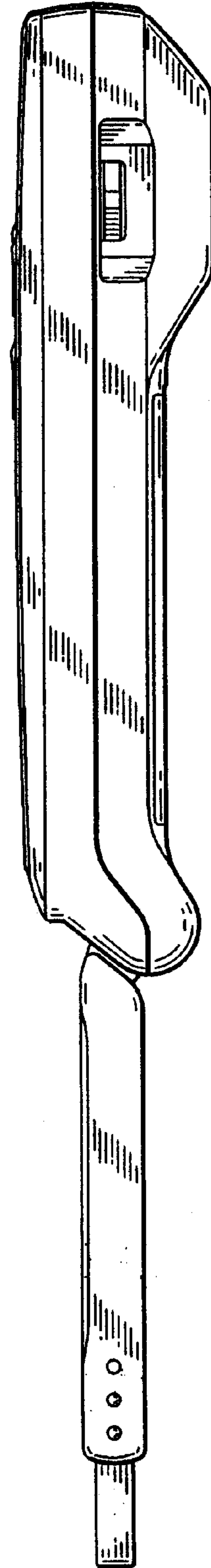

FIG.8

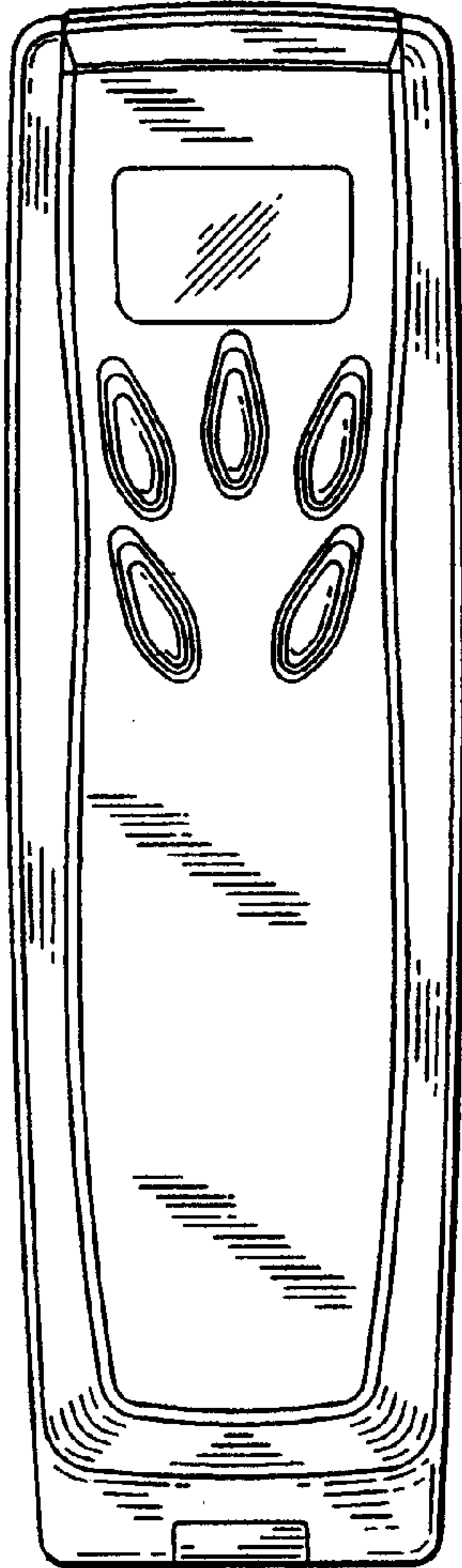

FIG.9

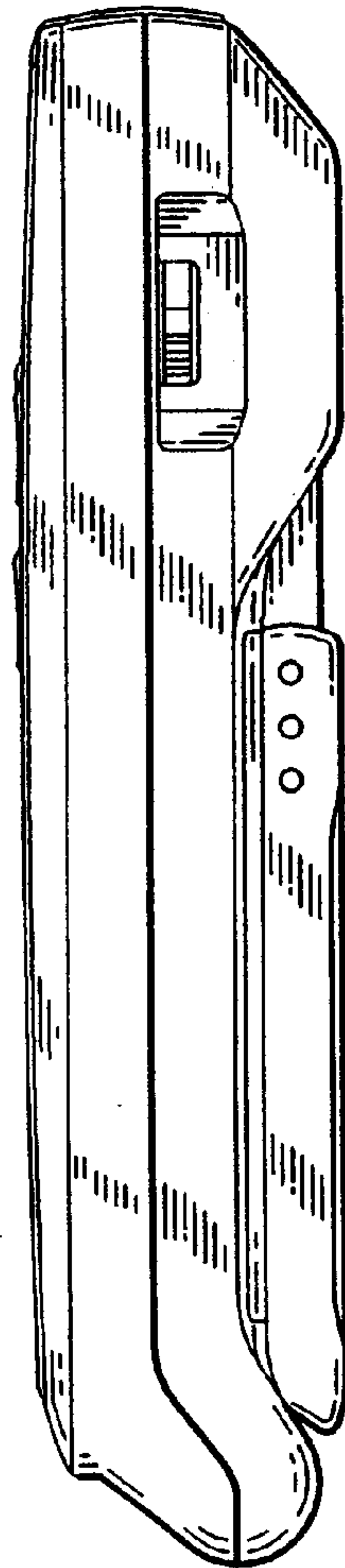

FIG.10

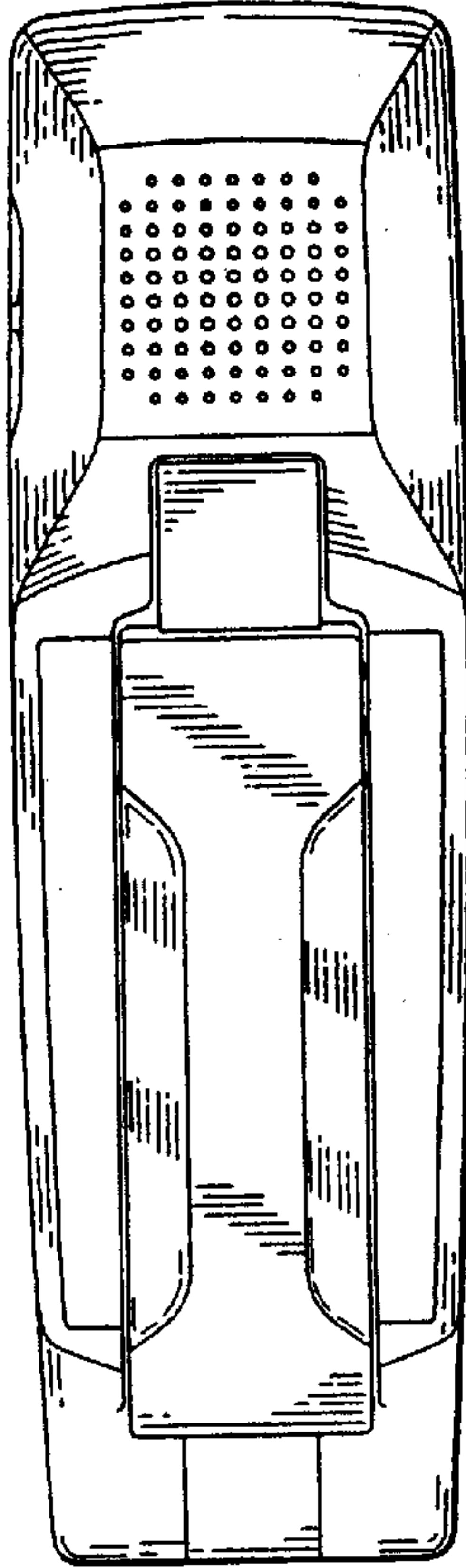

FIG.11

