



US00D487192S

(12) **United States Design Patent**
Farnham et al.

(10) **Patent No.:** **US D487,192 S**

(45) **Date of Patent:** **** Mar. 2, 2004**

(54) **STORAGE UNIT**

D449,165 S * 10/2001 van der Hulst D3/294
D463,276 S * 9/2002 Piscopo et al. D9/420

(75) Inventors: **Mark P. Farnham**, Port Jefferson, NY
(US); **Clive Warwicker**, Worcestershire
(GB)

* cited by examiner

Primary Examiner—Philip S. Hyder

(73) Assignee: **Helix Group PLC**, Stourbridge (GB)

(74) *Attorney, Agent, or Firm*—Pillsbury Winthrop LLP

(**) Term: **14 Years**

(57) **CLAIM**

(21) Appl. No.: **29/166,445**

The ornamental design for a storage unit, as shown and described.

(22) Filed: **Aug. 28, 2002**

DESCRIPTION

(51) **LOC (7) Cl.** **03-01**

FIG. 1 is a top plan view of a storage unit according to the present invention with selected structure indicated in dotted lines;

(52) **U.S. Cl.** **D3/294**

FIG. 2 is a bottom plan view thereof with selected structure indicated in dotted lines;

(58) **Field of Search** D3/272, 273, 294,
D3/302, 281; D9/423, 424, 425; D99/28;
206/349, 508, 518; 220/324, 810, 837,
796; 70/63, 66, 69, 67

FIG. 3 is a right side elevational view thereof with selected structure indicated in dotted lines;

(56) **References Cited**

U.S. PATENT DOCUMENTS

| | | | | | | |
|-----------|----|---|---------|-----------------------|-------|----------|
| 2,687,157 | A | * | 8/1954 | Cowan | | 220/4.23 |
| 4,066,195 | A | | 1/1978 | Dickler | | |
| D273,908 | S | * | 5/1984 | Hoogeveen | | D99/28 |
| 4,474,116 | A | | 10/1984 | Castenada, Jr. et al. | | 109/51 |
| 4,573,332 | A | | 3/1986 | Ma | | 70/30 |
| D284,831 | S | | 7/1986 | Warwicker | | D8/306 |
| 4,611,711 | A | | 9/1986 | Warwicker | | 206/0.81 |
| D291,139 | S | | 7/1987 | Warwicker | | D99/28 |
| D296,949 | S | | 7/1988 | Warwicker | | D99/34 |
| D297,195 | S | * | 8/1988 | Warwicker | | D6/559 |
| 4,843,848 | A | | 7/1989 | Igelmund | | 70/58 |
| 5,150,834 | A | | 9/1992 | Bourke | | |
| D350,002 | S | * | 8/1994 | Viola | | D99/28 |
| D363,669 | S | * | 10/1995 | Pennoyer, Jr. | | D9/423 |
| D364,563 | S | * | 11/1995 | Miller et al. | | D9/423 |
| 5,517,835 | A | | 5/1996 | Smith | | |
| D371,906 | S | | 7/1996 | Peters | | D3/281 |
| 5,531,082 | A | | 7/1996 | Wolk et al. | | 70/63 |
| 5,595,073 | A | | 1/1997 | Sullivan | | 70/14 |
| D393,526 | S | * | 4/1998 | Robey et al. | | D99/28 |
| 5,762,169 | A | | 6/1998 | Deliman et al. | | 109/101 |
| D406,057 | S | * | 2/1999 | Hager | | D9/420 |
| 6,006,558 | A | | 12/1999 | Peters | | 70/63 |
| 6,185,964 | B1 | * | 2/2001 | Addiego | | 70/58 |

FIG. 4 is left side elevational view thereof with selected structure indicated in dotted lines;

FIG. 5 is a front elevational view thereof with selected structure indicated in dotted lines;

FIG. 6 is a rear elevational view thereof with selected structure indicated in dotted lines;

FIG. 7 is a perspective view of the storage unit illustrated in FIG. 1, shown in a closed position with selected structure indicated in dotted lines;

FIG. 8 is a perspective view, from the rear and right side, of the storage unit illustrated in FIG. 1, shown in a closed position with selected structure indicated in dotted lines;

FIG. 9 is a perspective view, from the front and left side, of the storage unit illustrated in FIG. 1, shown in an open position with selected structure indicated in dotted lines; and,

FIG. 10 is a perspective view, from the rear and right side, of the storage unit illustrated in FIG. 1, shown in an open position with selected structure indicated in dotted lines.

The dotted line showings of the storage unit or parts thereof, such as the hinge, the lock assembly and the cable, are for illustrative purposes only and form no part of the claimed design.

1 Claim, 6 Drawing Sheets

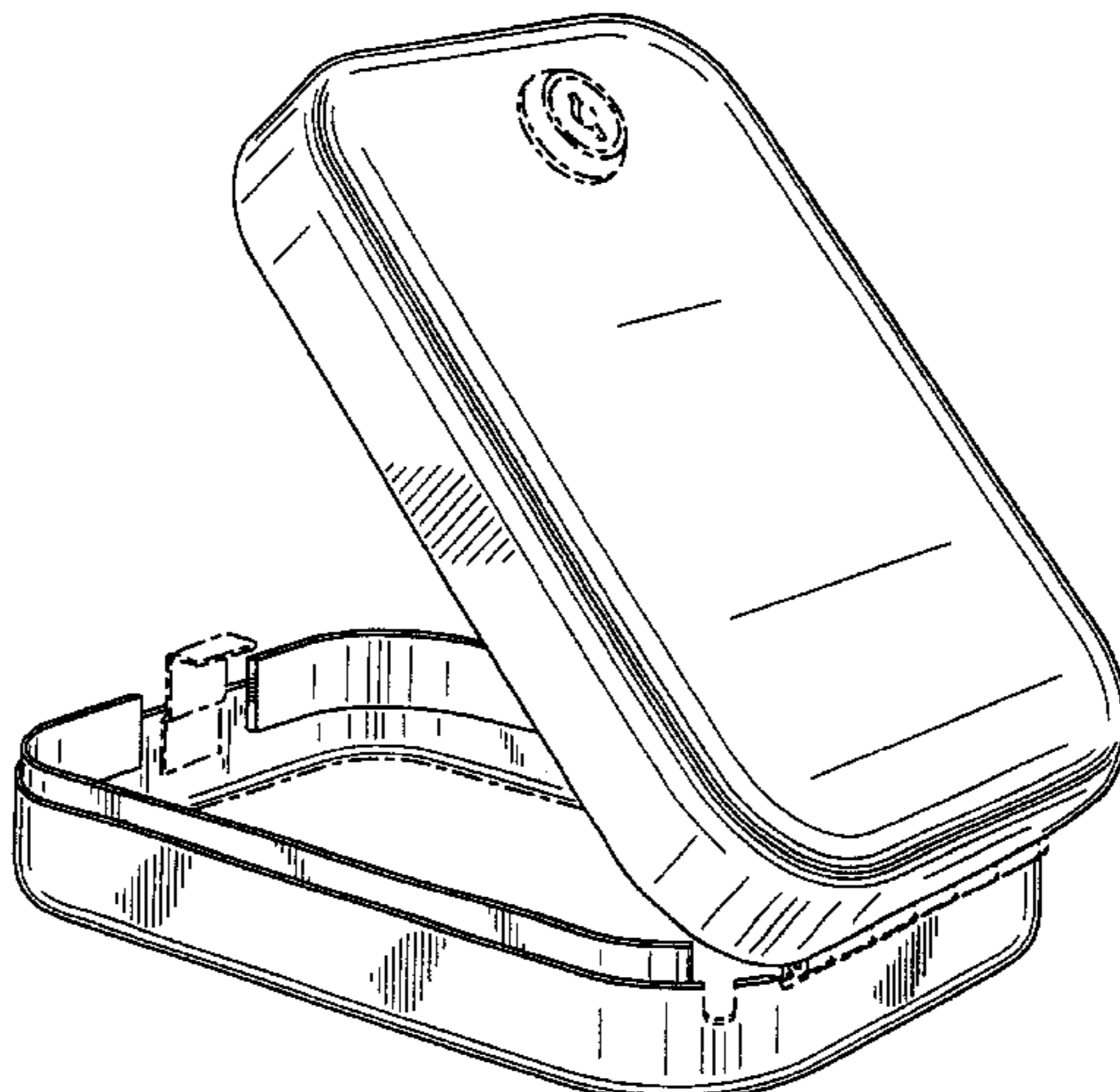

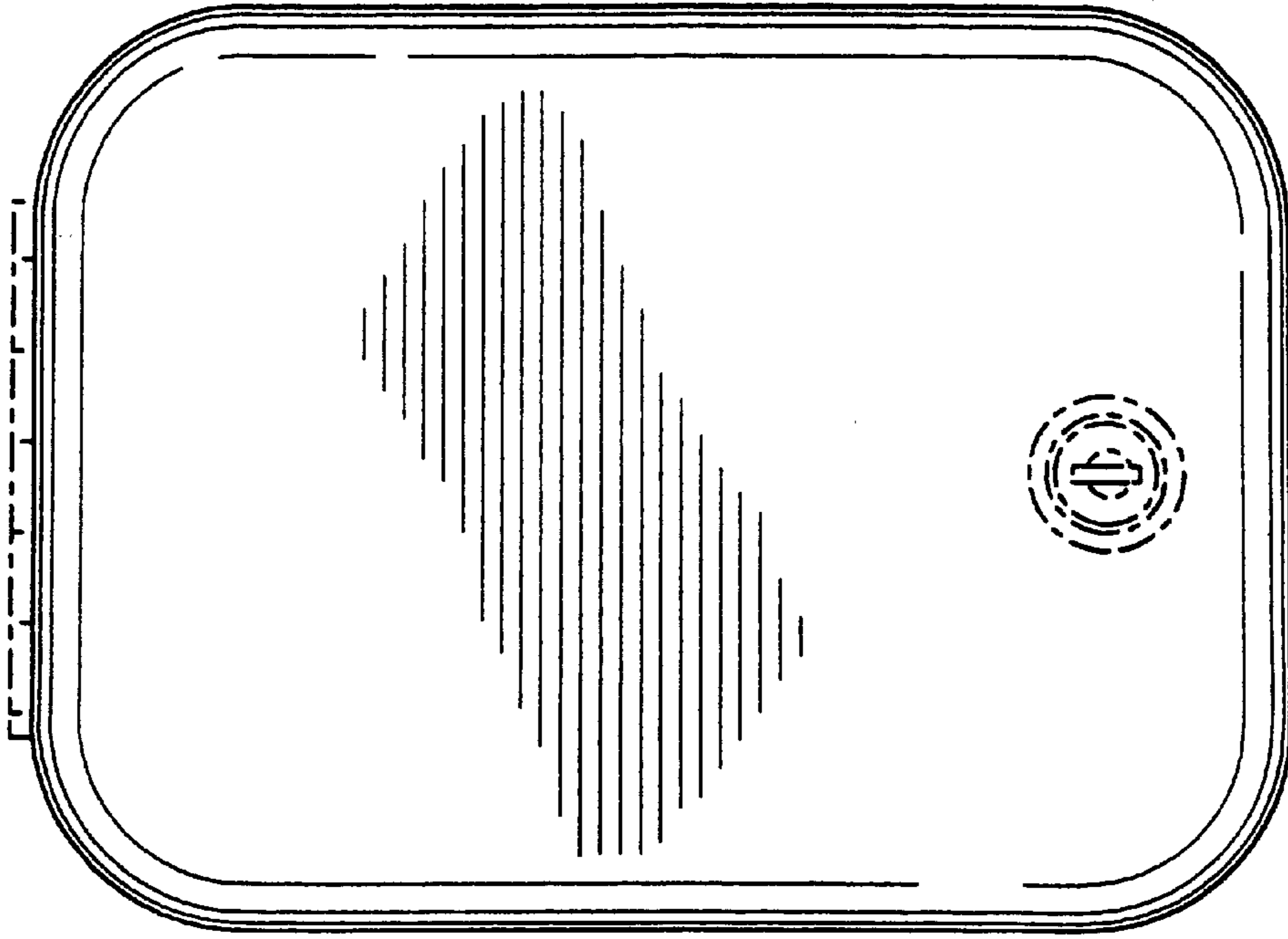

FIG. 1

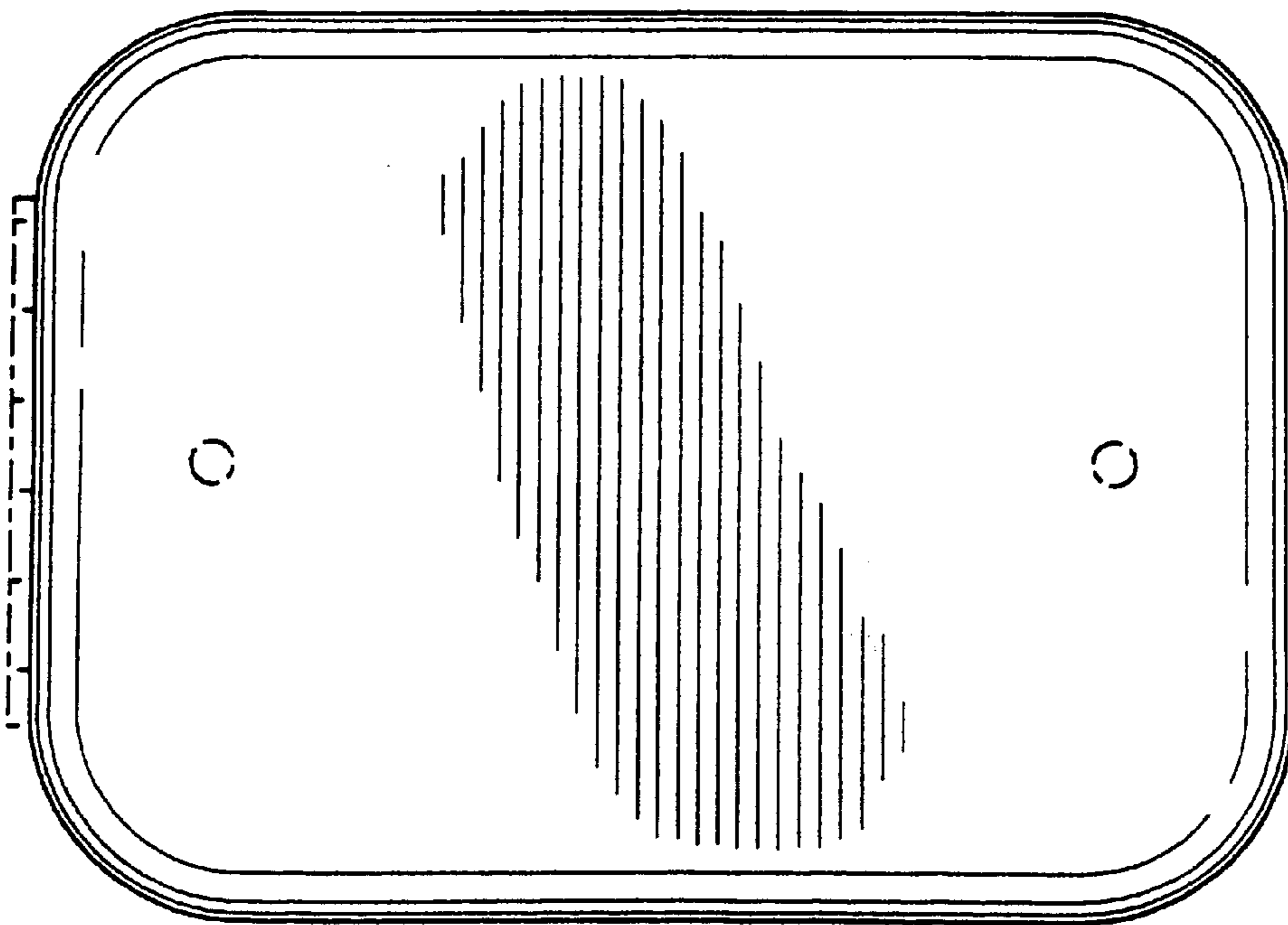

FIG. 2

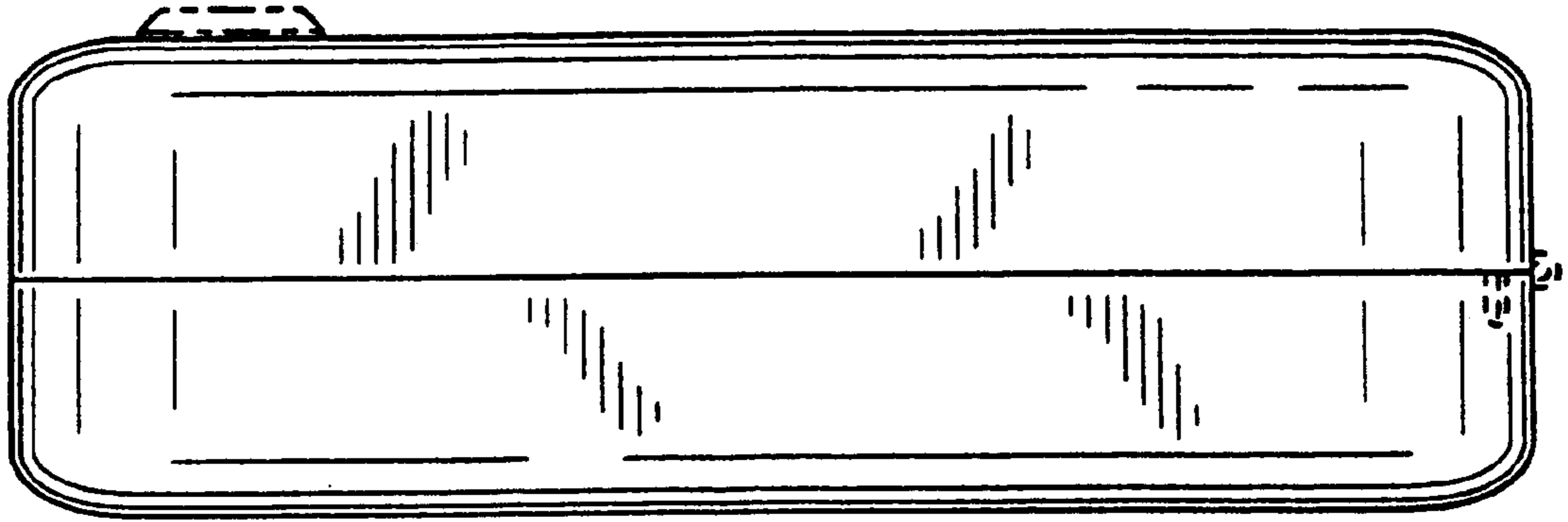

FIG. 3

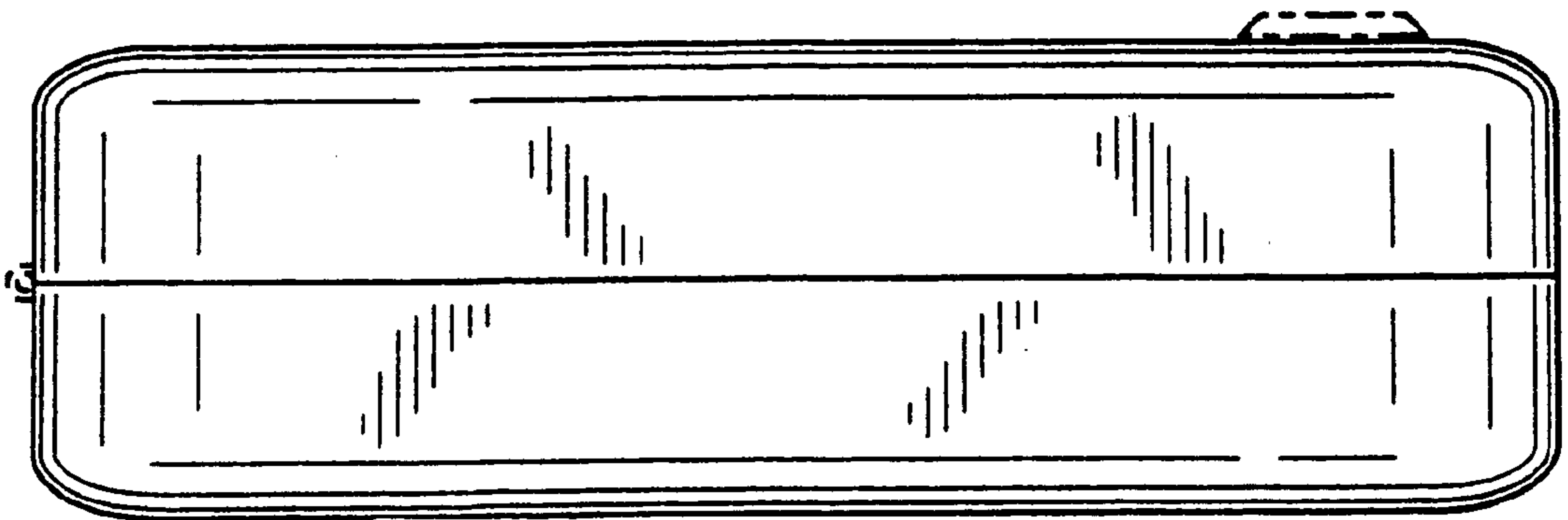

FIG. 4

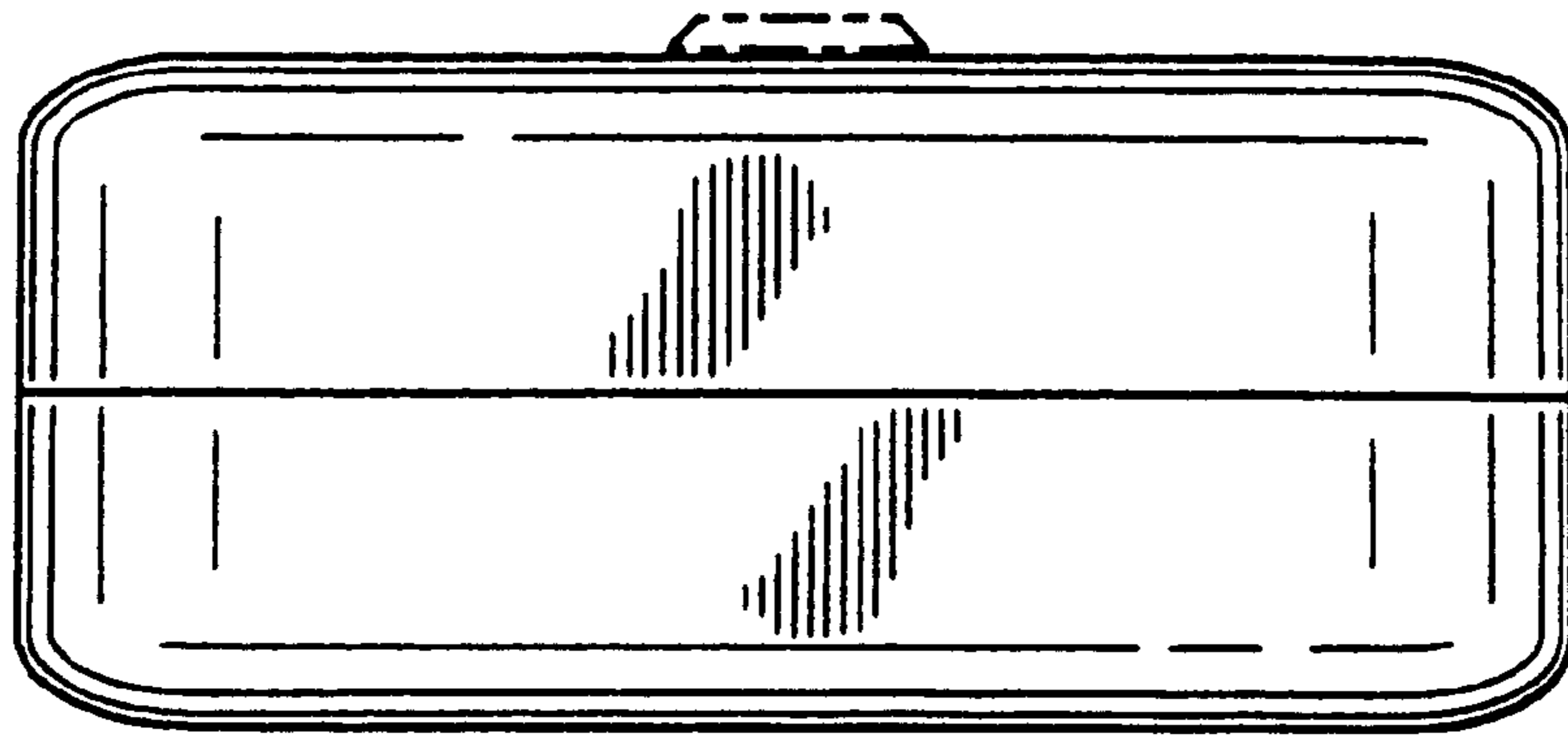

FIG. 5

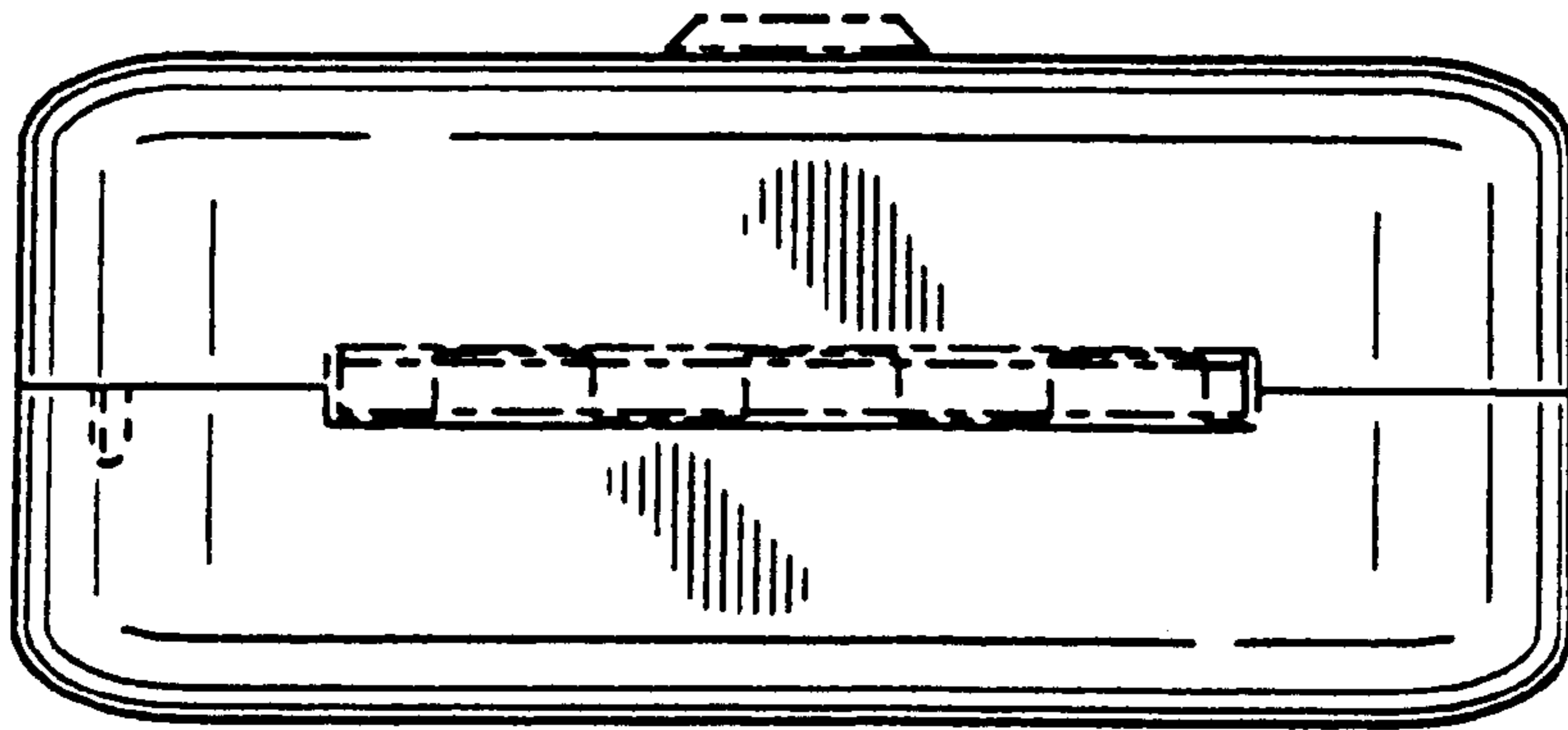

FIG. 6

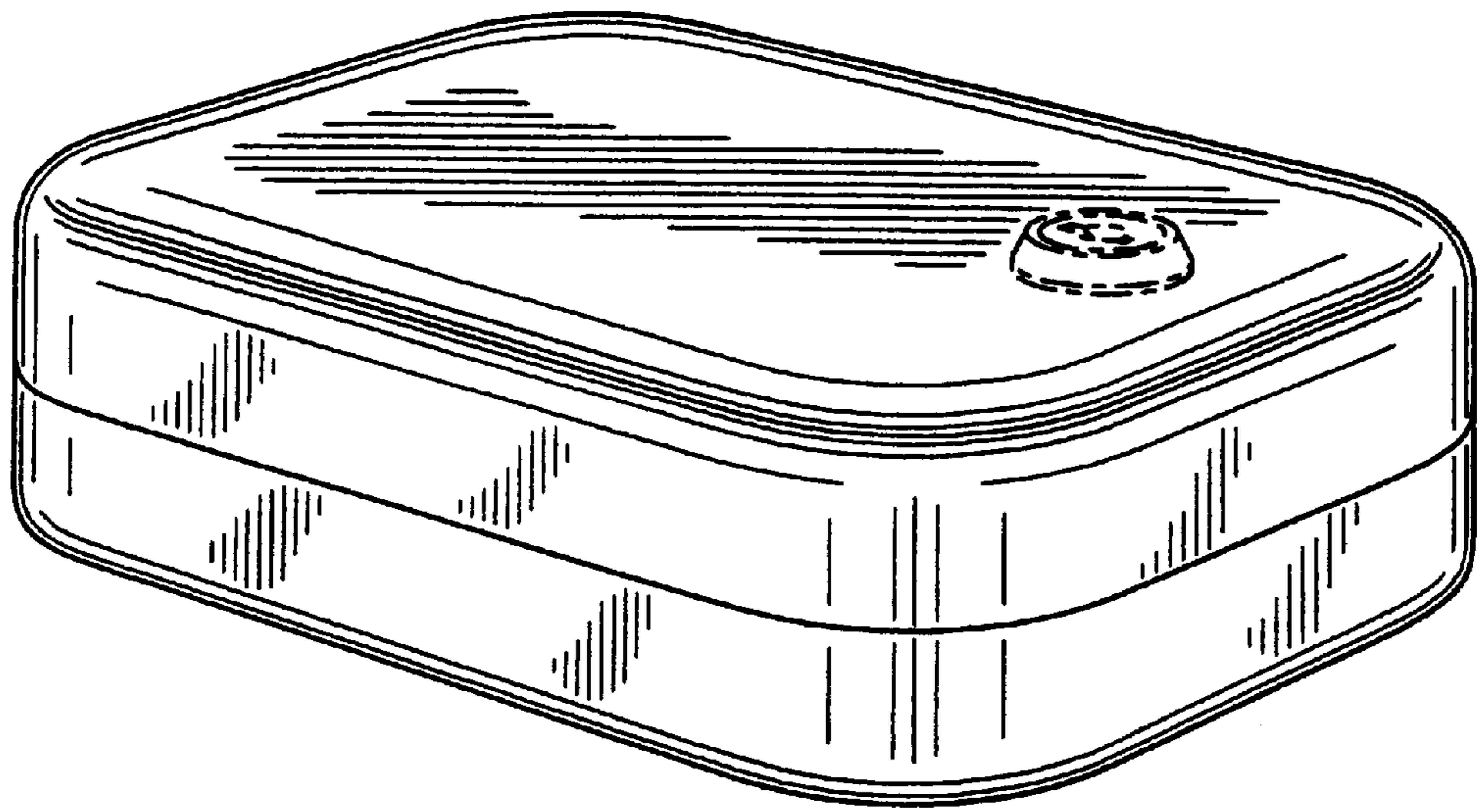

FIG. 7

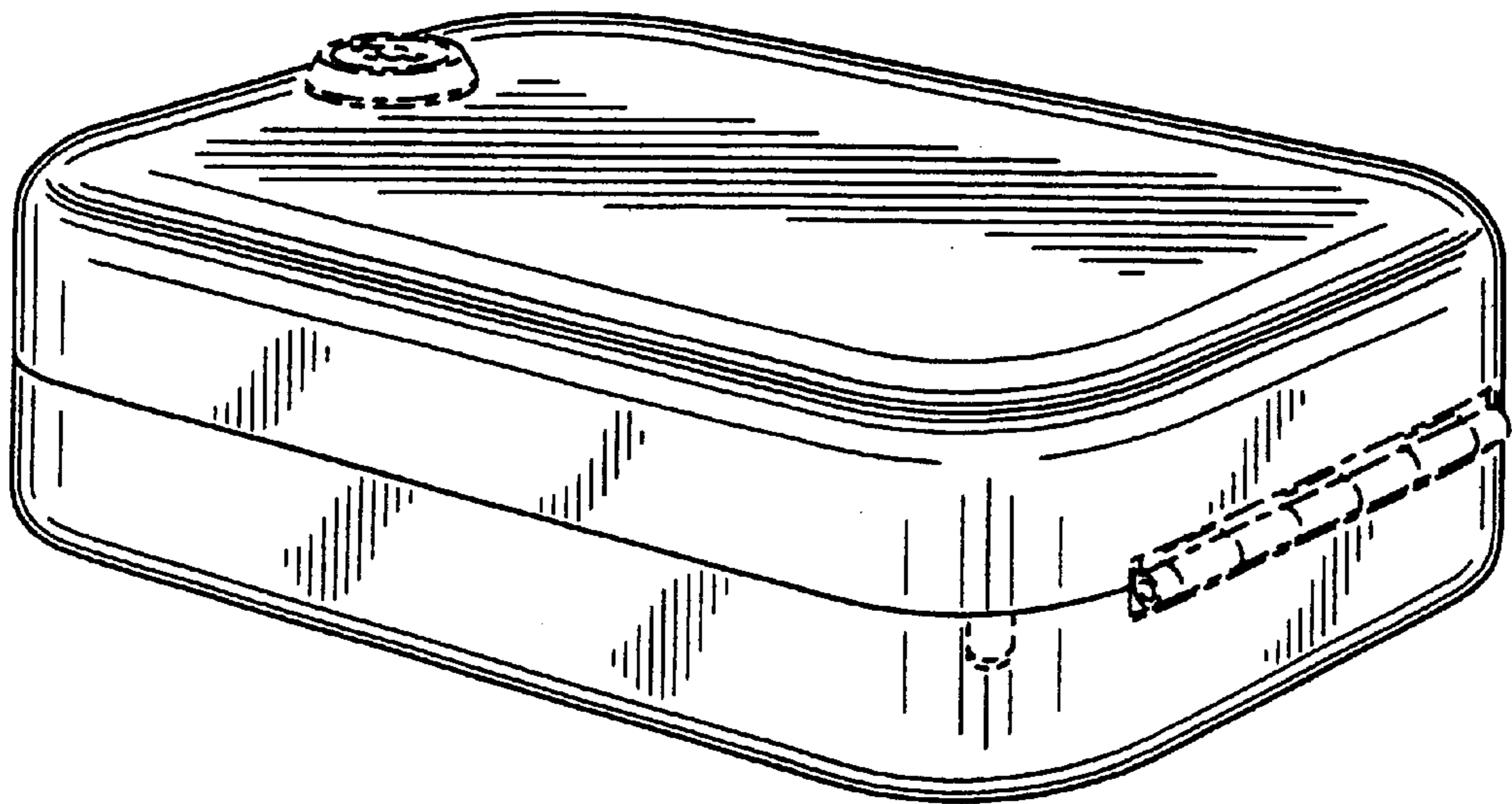

FIG. 8

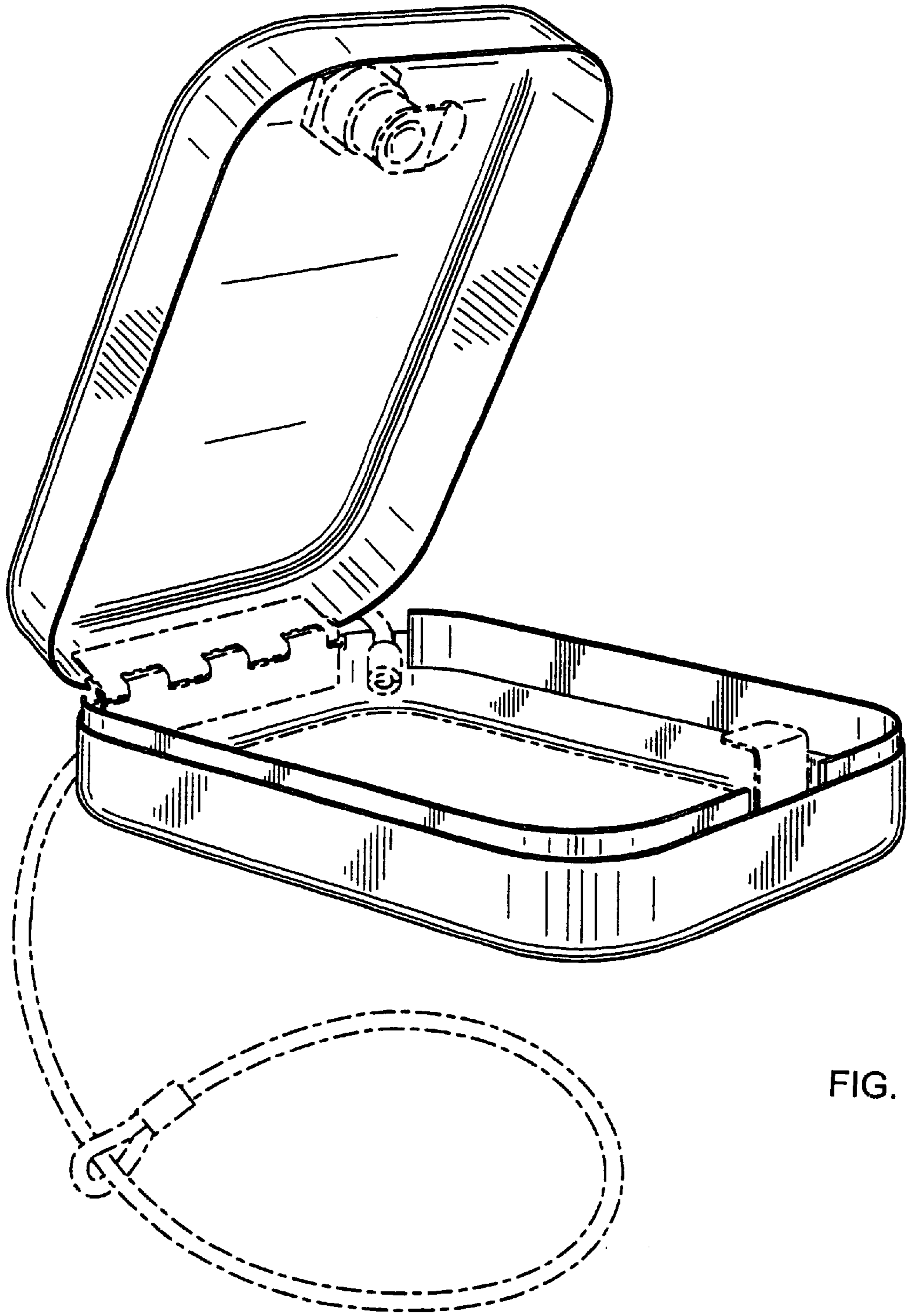

FIG. 9

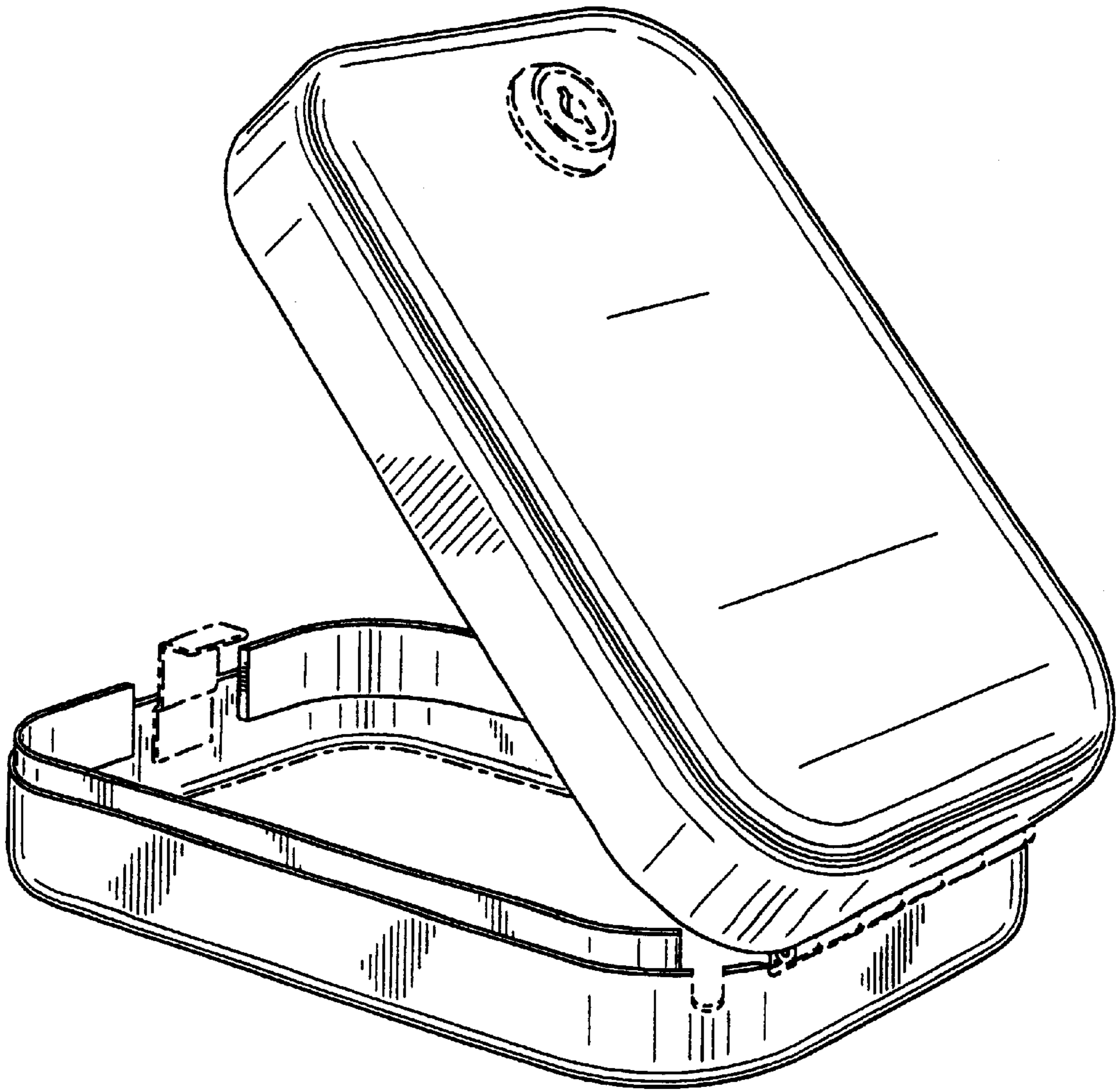

FIG. 10