



US00D487137S

(12) **United States Design Patent**  
**Itakura**

(10) **Patent No.:** **US D487,137 S**

(45) **Date of Patent:** **\*\* Feb. 24, 2004**

(54) **LAVATORY UNIT OF AIRCRAFT**

(75) Inventor: **Ushio Itakura**, Tokyo (JP)

(73) Assignee: **Jamco Corporation**, Mitaka (JP)

(\*\*) Term: **14 Years**

(21) Appl. No.: **29/176,761**

(22) Filed: **Feb. 28, 2003**

(30) **Foreign Application Priority Data**

Sep. 10, 2002 (JP) ..... 2002-024628

(51) **LOC (7) Cl.** ..... **23-02**

(52) **U.S. Cl.** ..... **D23/274**

(58) **Field of Search** ..... D23/270–271,  
D23/274, 295–296, 299, 303, 309; 4/662,  
664, 670, DIG. 7, 300, DIG. 15; D12/195

(56) **References Cited**

**U.S. PATENT DOCUMENTS**

D155,363 S	*	9/1949	Ray et al. ....	D12/195
D203,253 S	*	12/1965	de Kanter .....	D23/273
4,718,131 A	*	1/1988	Kitamura et al. ....	4/664 X
4,884,767 A	*	12/1989	Shibata .....	D12/195 X
5,742,956 A	*	4/1998	Tarver .....	4/664 X
D416,313 S	*	11/1999	Foster .....	D23/299
D460,537 S	*	7/2002	Gilbert .....	D23/274
D470,228 S	*	2/2003	Wheeler, III .....	D23/274

\* cited by examiner

*Primary Examiner*—Louis S. Zarfes

*Assistant Examiner*—Robert A. Delehanty

(74) *Attorney, Agent, or Firm*—Westerman, Hattori,  
Daniels & Adrian, LLP

(57) **CLAIM**

The ornamental design for a lavatory unit of aircraft, as shown and described.

**DESCRIPTION**

FIG. 1 is a front elevational view of the lavatory unit of aircraft.

FIG. 2 is a rear elevational view thereof.

FIG. 3 is a right side elevational view thereof.

FIG. 4 is a left side elevational view thereof.

FIG. 5 is a top view thereof.

FIG. 6 is a bottom view thereof.

FIG. 7 is a cross-sectional view thereof along VII—VII with a pivotally movable step retracted (see on the lower right side).

FIG. 8 is a cross-sectional view thereof along VII—VII with a pivotally movable step extended.

FIG. 9 is a cross-sectional view thereof along IX—IX.

FIG. 10 is a cross-sectional view thereof along X—X with a pivotally movable diaper changing table retracted (see on the middle left side).

FIG. 11 is a cross-sectional view thereof along X—X with a pivotally movable diaper changing table extended.

FIG. 12 is a cross-sectional view thereof along XII—XII with a pivotally movable step retracted (see on the lower right side).

FIG. 13 is a cross-sectional view thereof along XII—XII with a pivotally movable step extended.

FIG. 14 is a top right side perspective view thereof with the door closed.

FIG. 15 is a right side perspective view thereof with the door open.

FIG. 16 is a top right side perspective view thereof with the enclosing walls removed; and,

FIG. 17 is a top perspective view thereof with the roof removed.

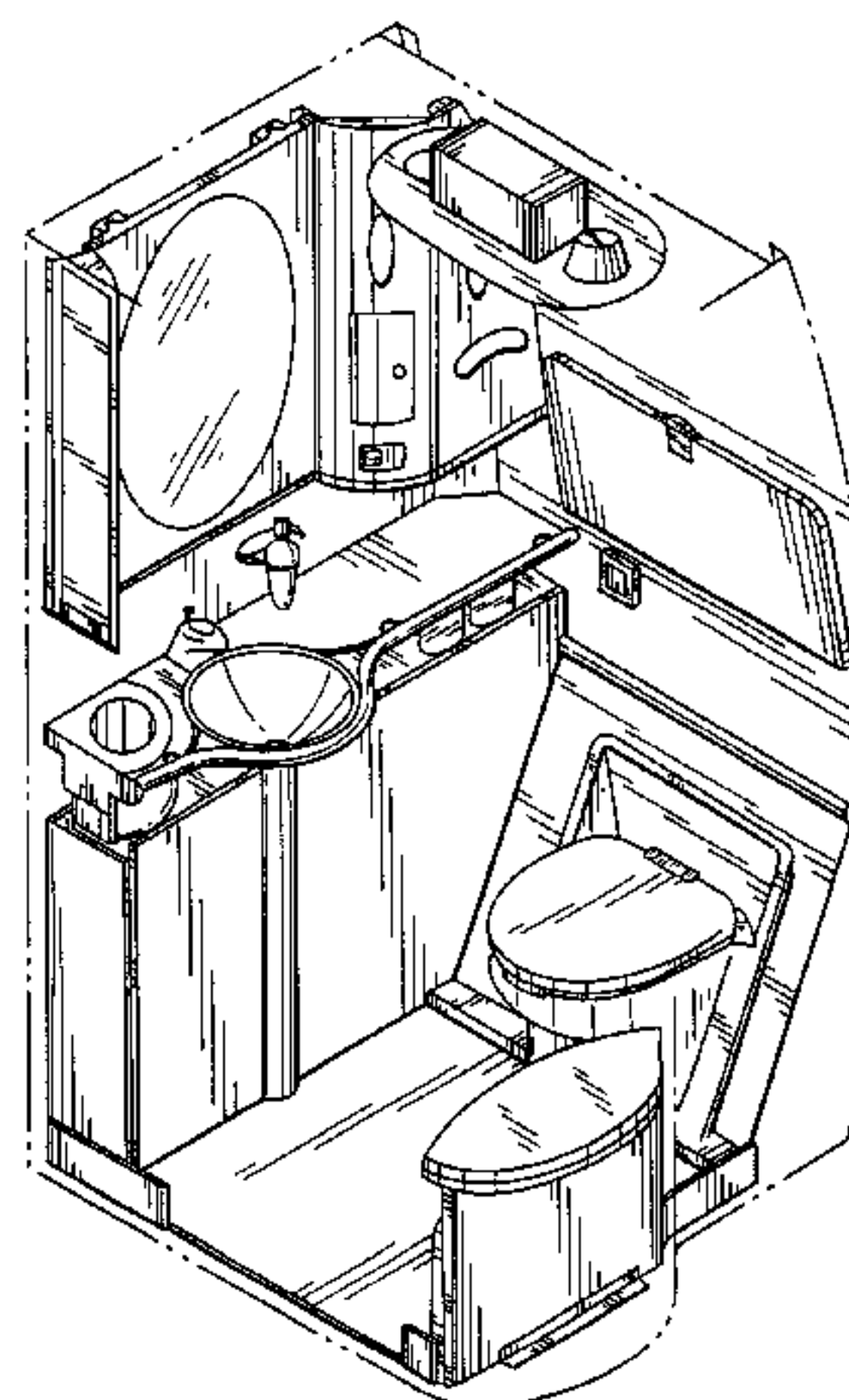
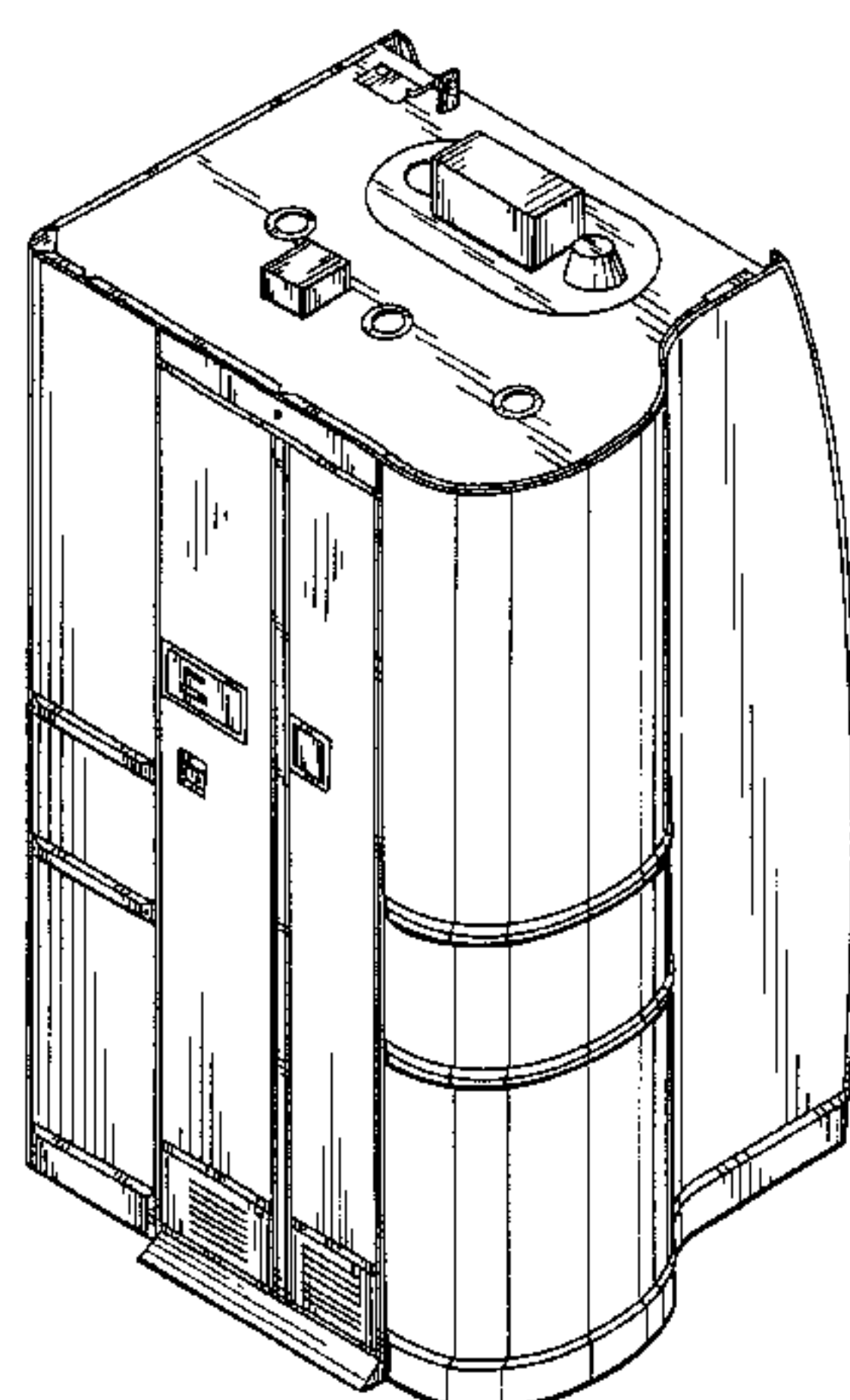

**1 Claim, 17 Drawing Sheets**

Fig. 1

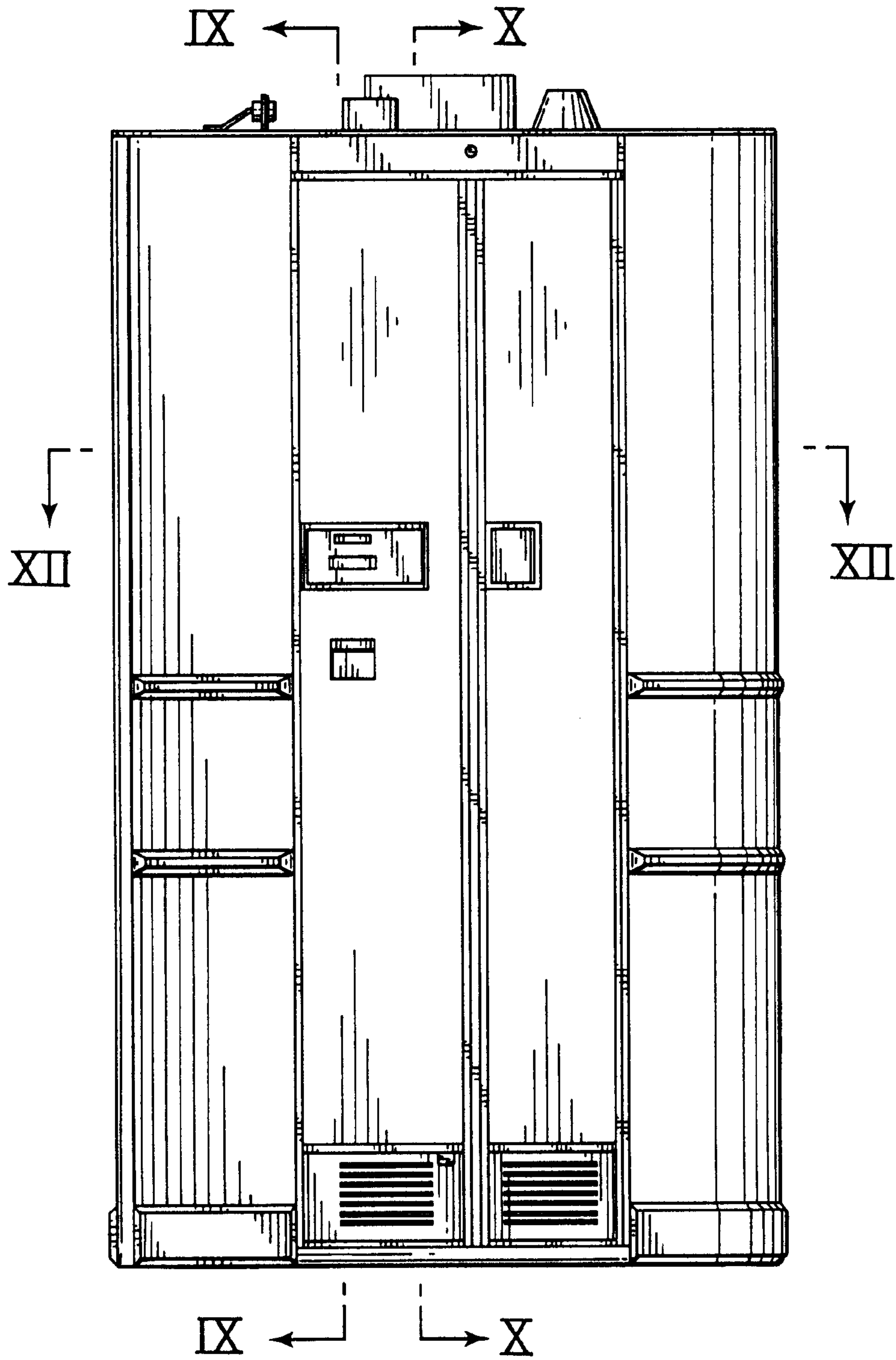

Fig.2

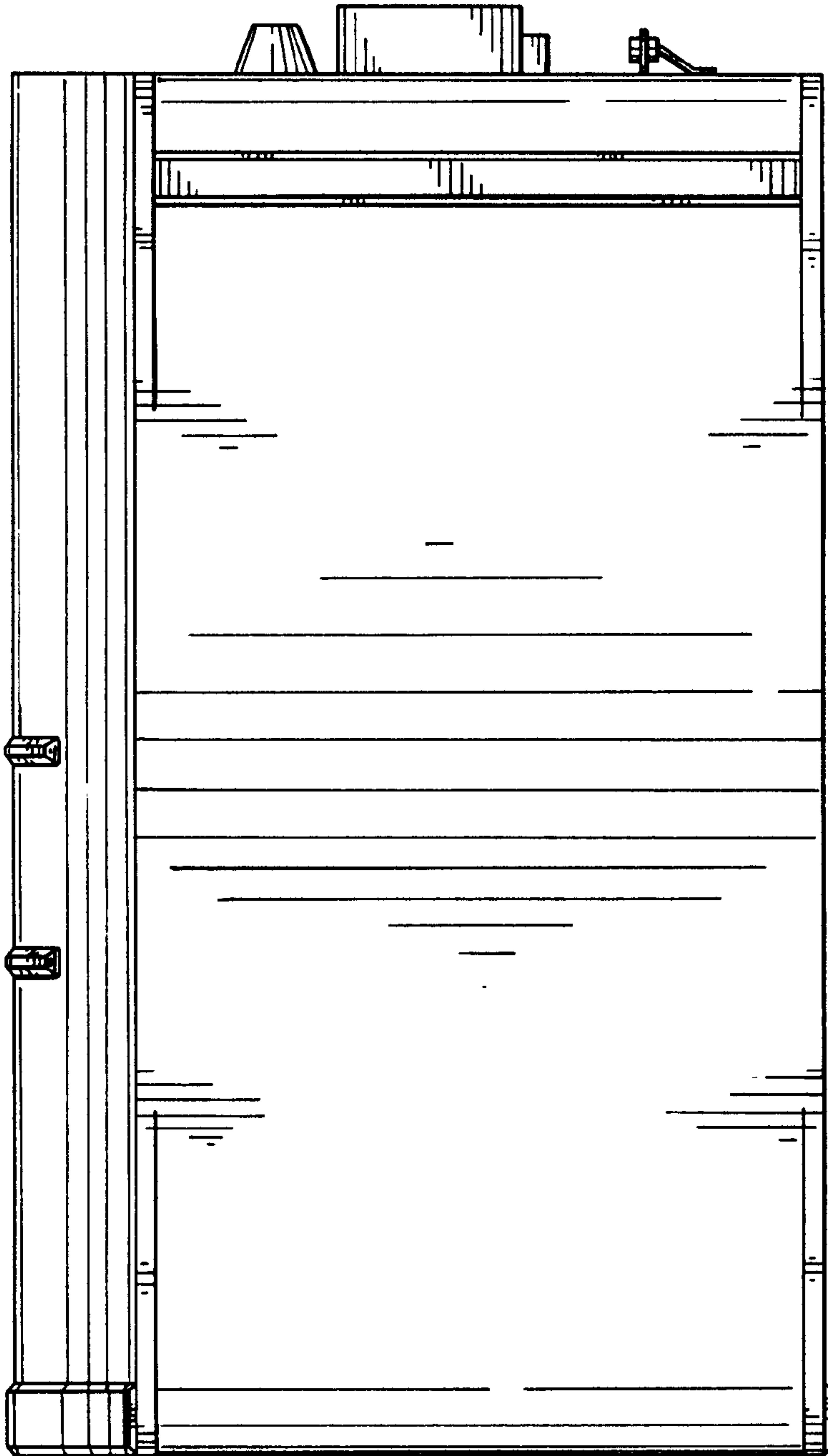

Fig.3

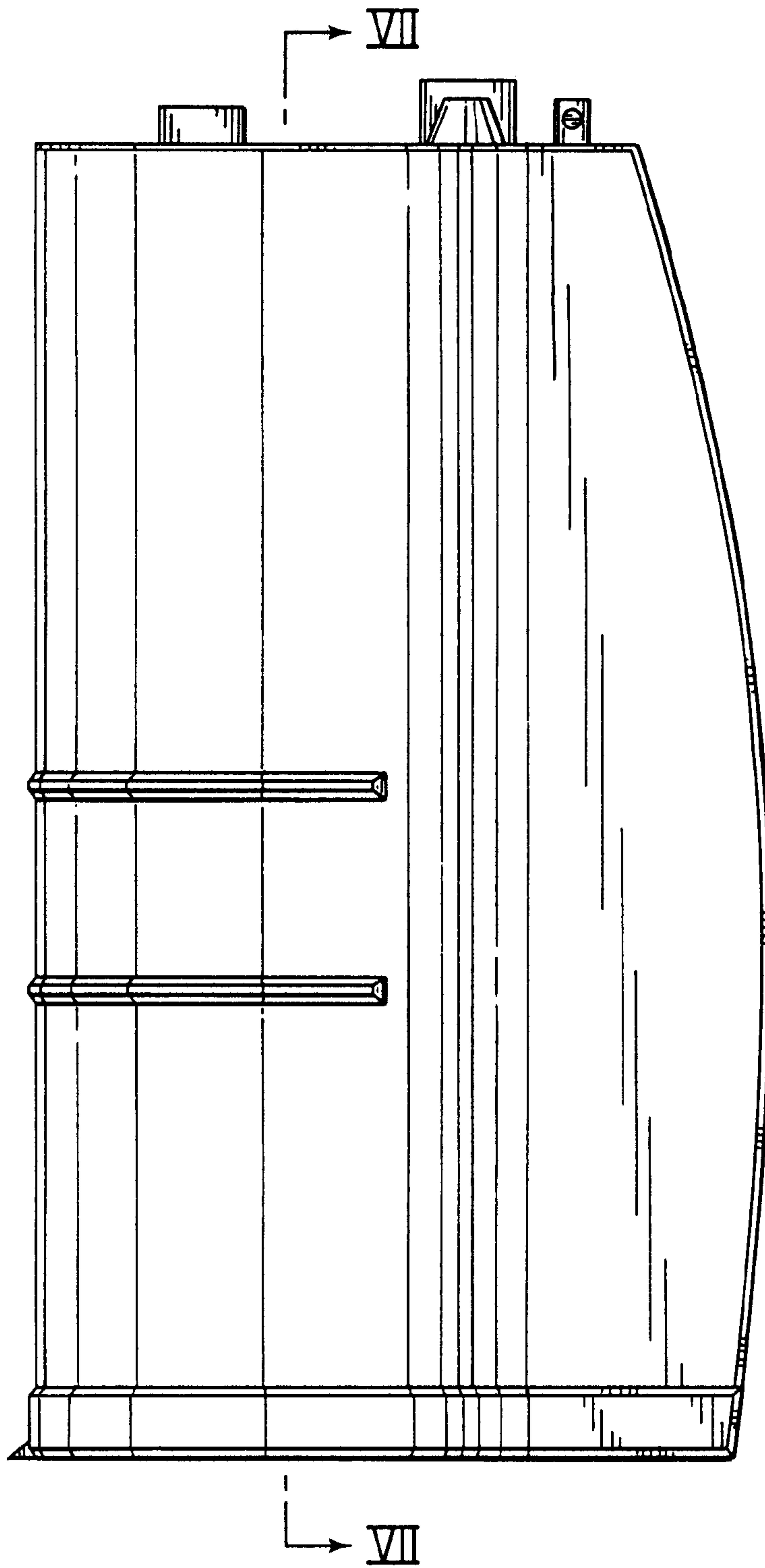

Fig.4

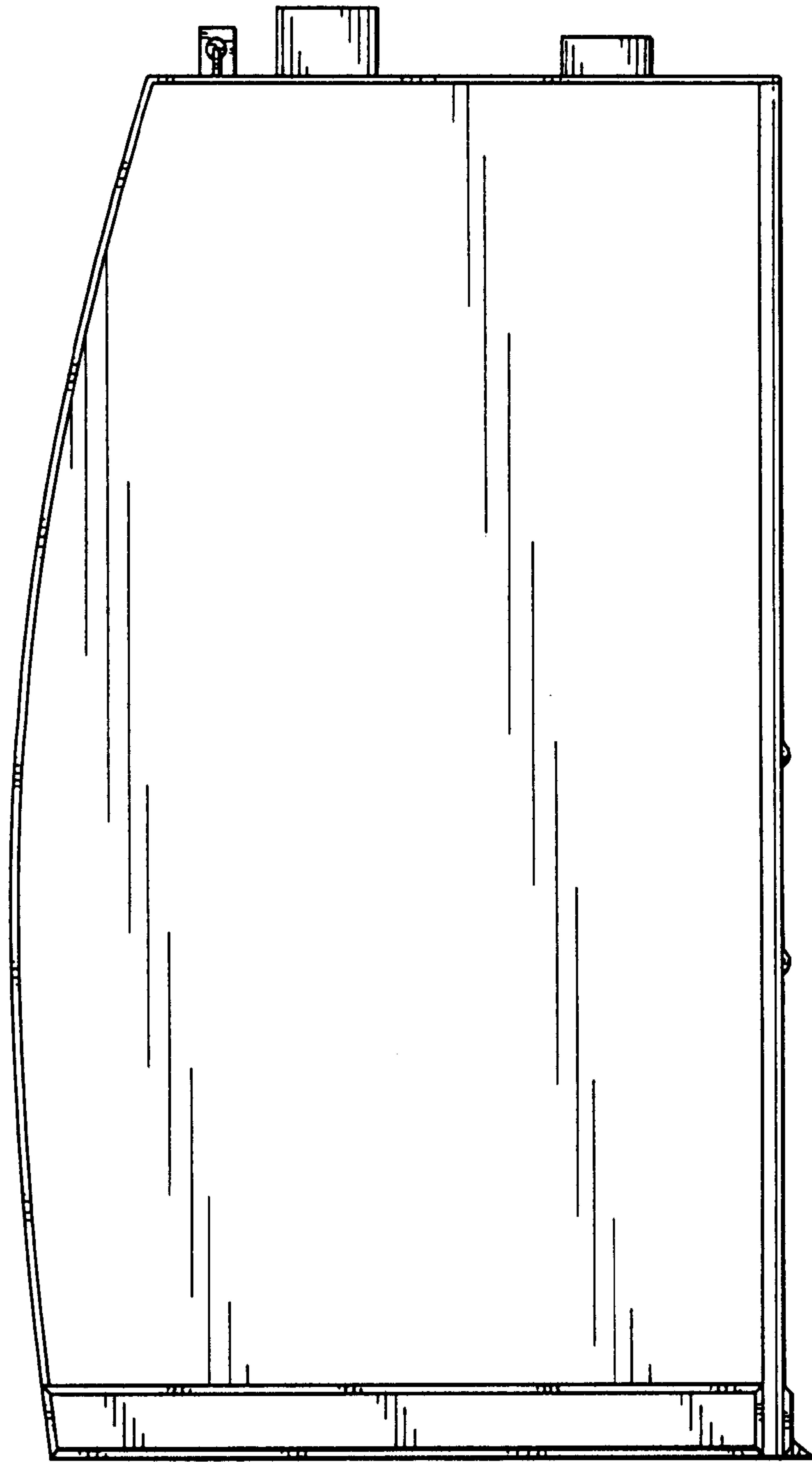

Fig.5

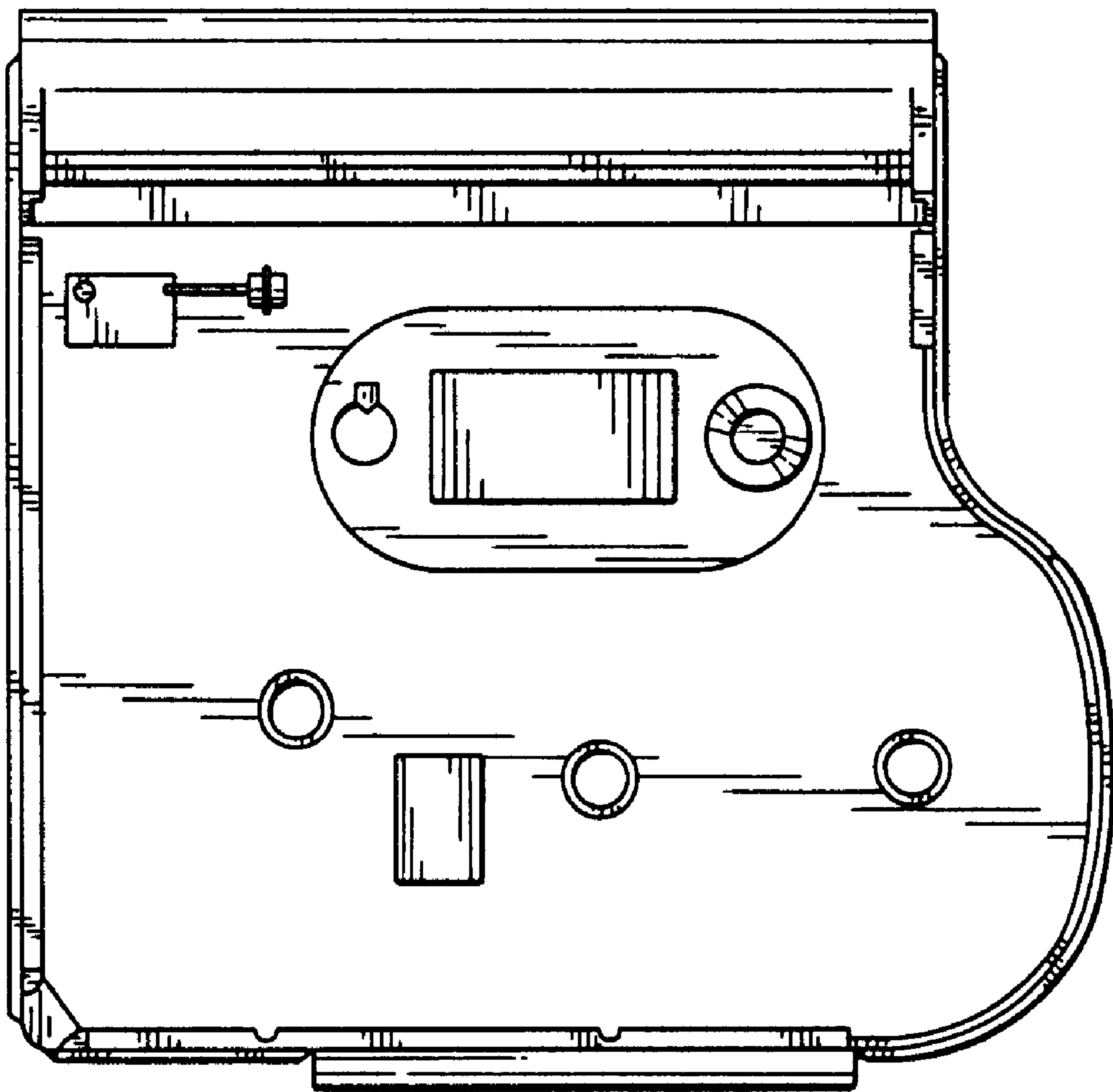

Fig.6

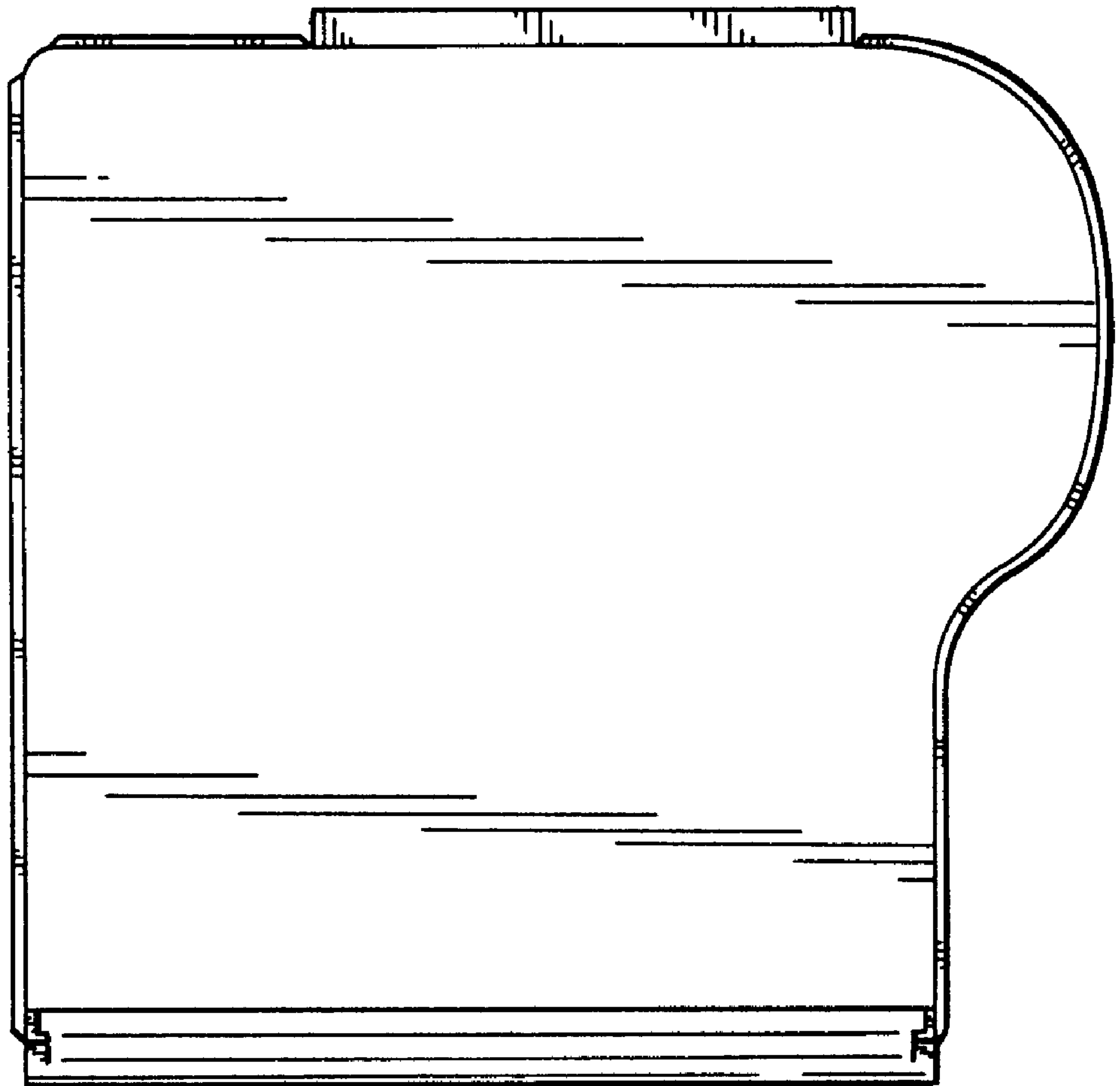



Fig.7

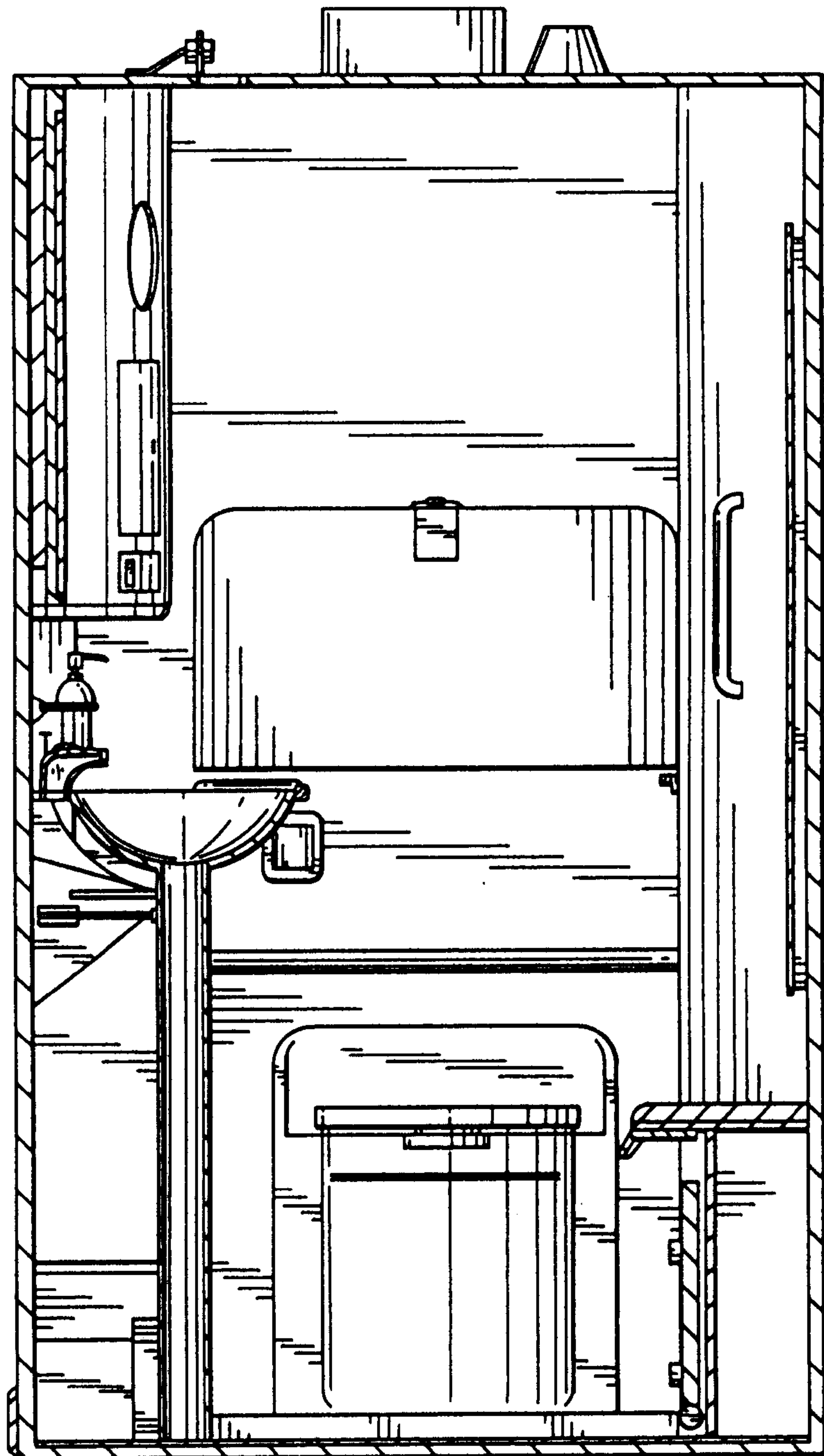



Fig.8

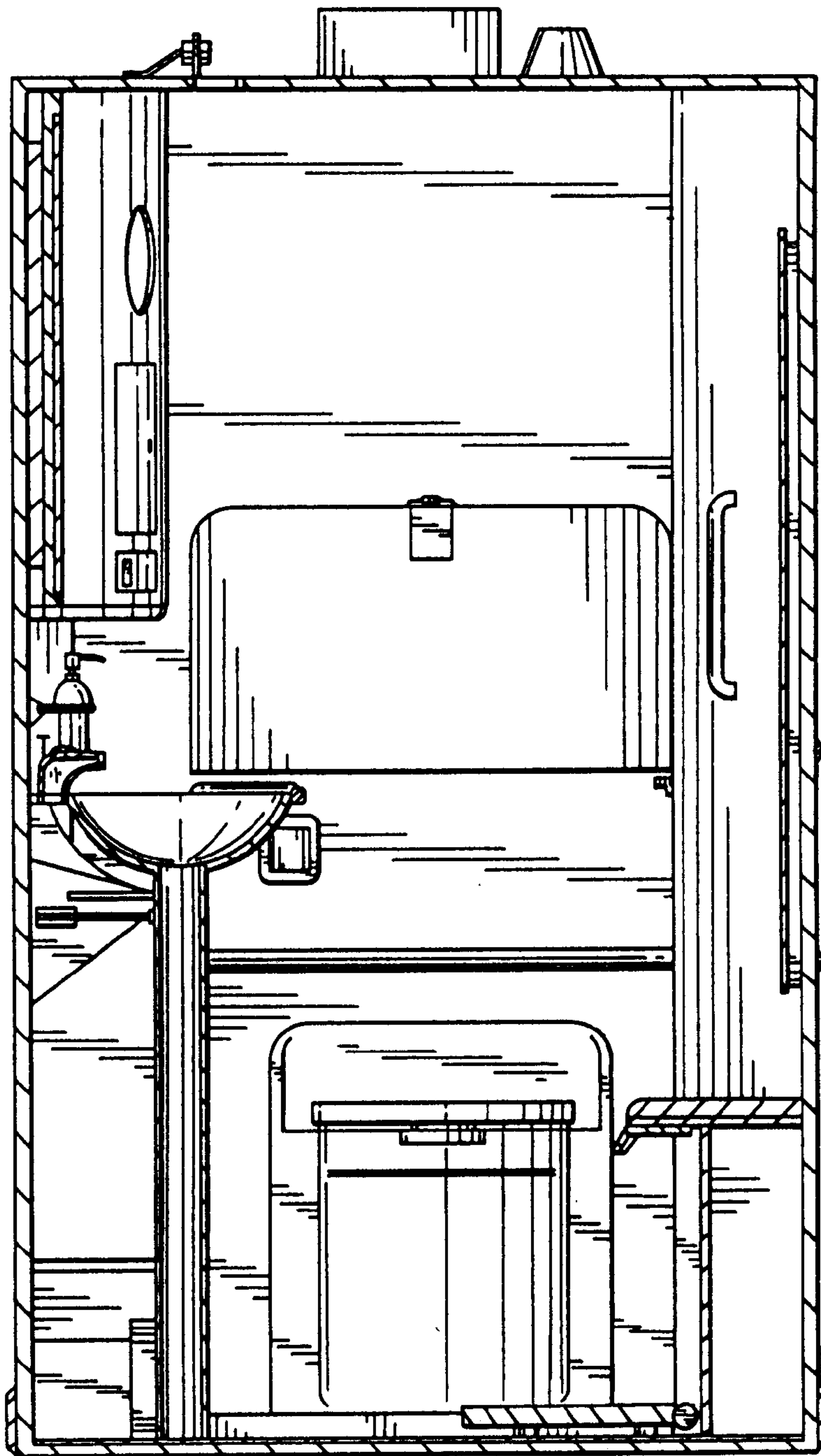

Fig.9

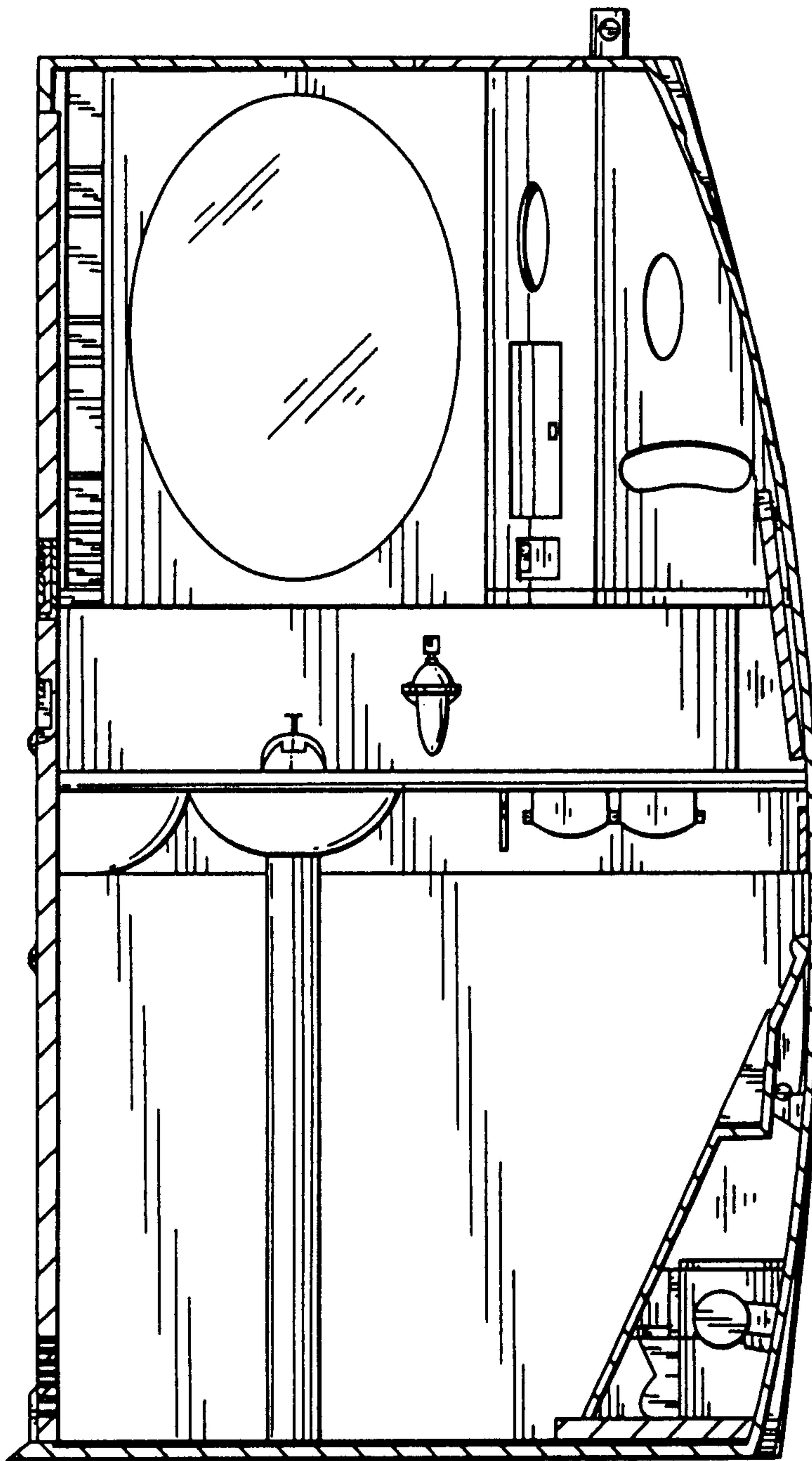

Fig.10

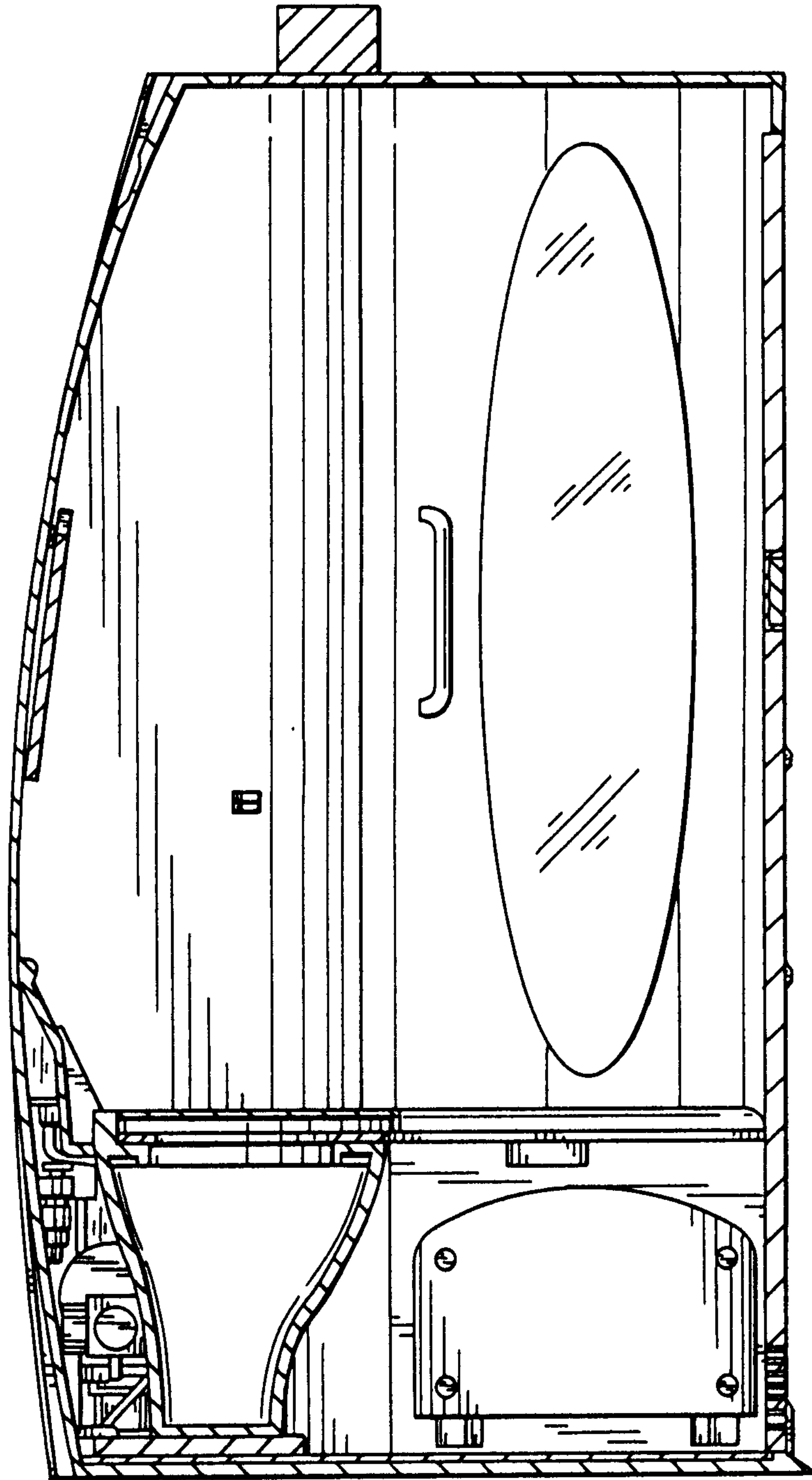

Fig.11

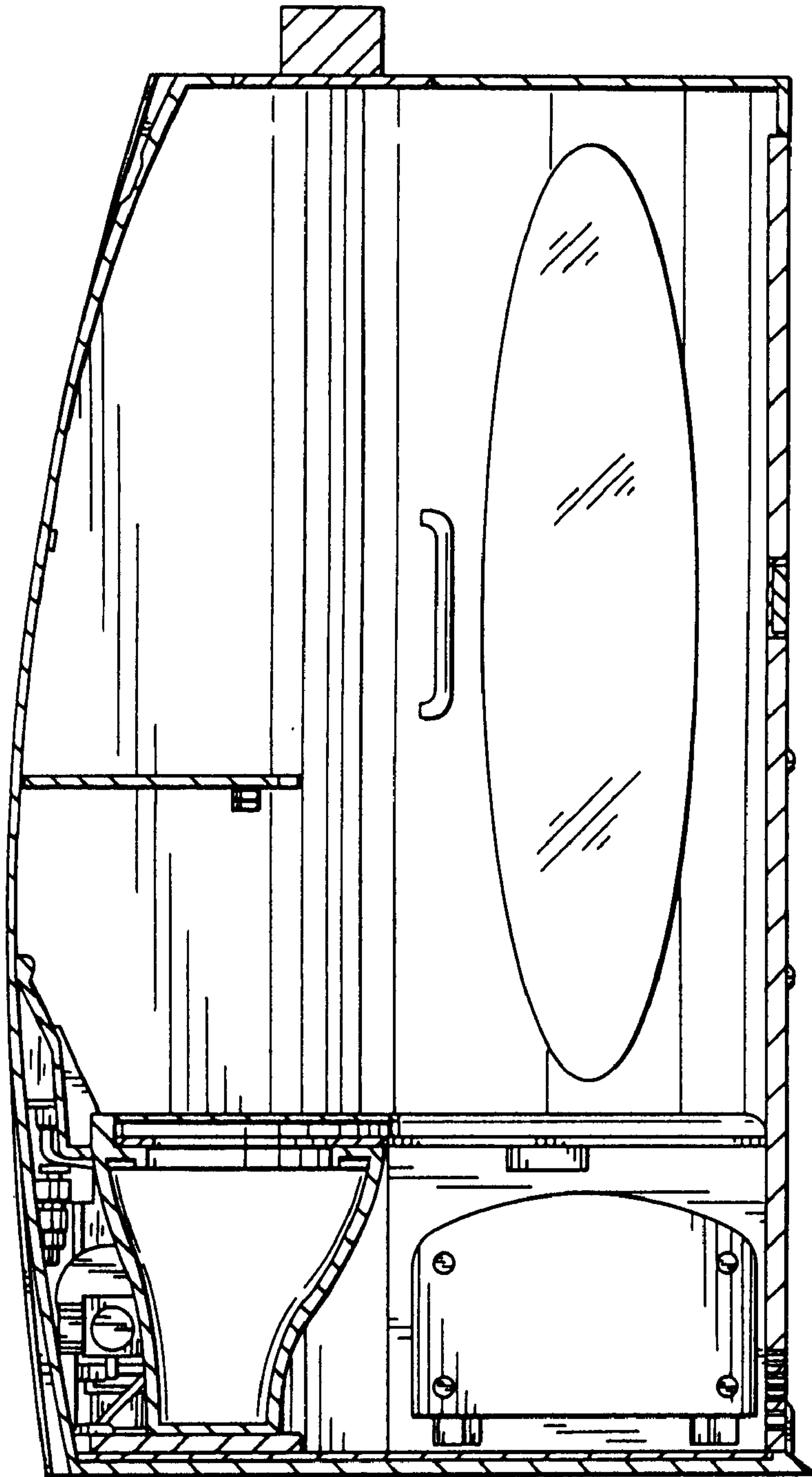

Fig. 12

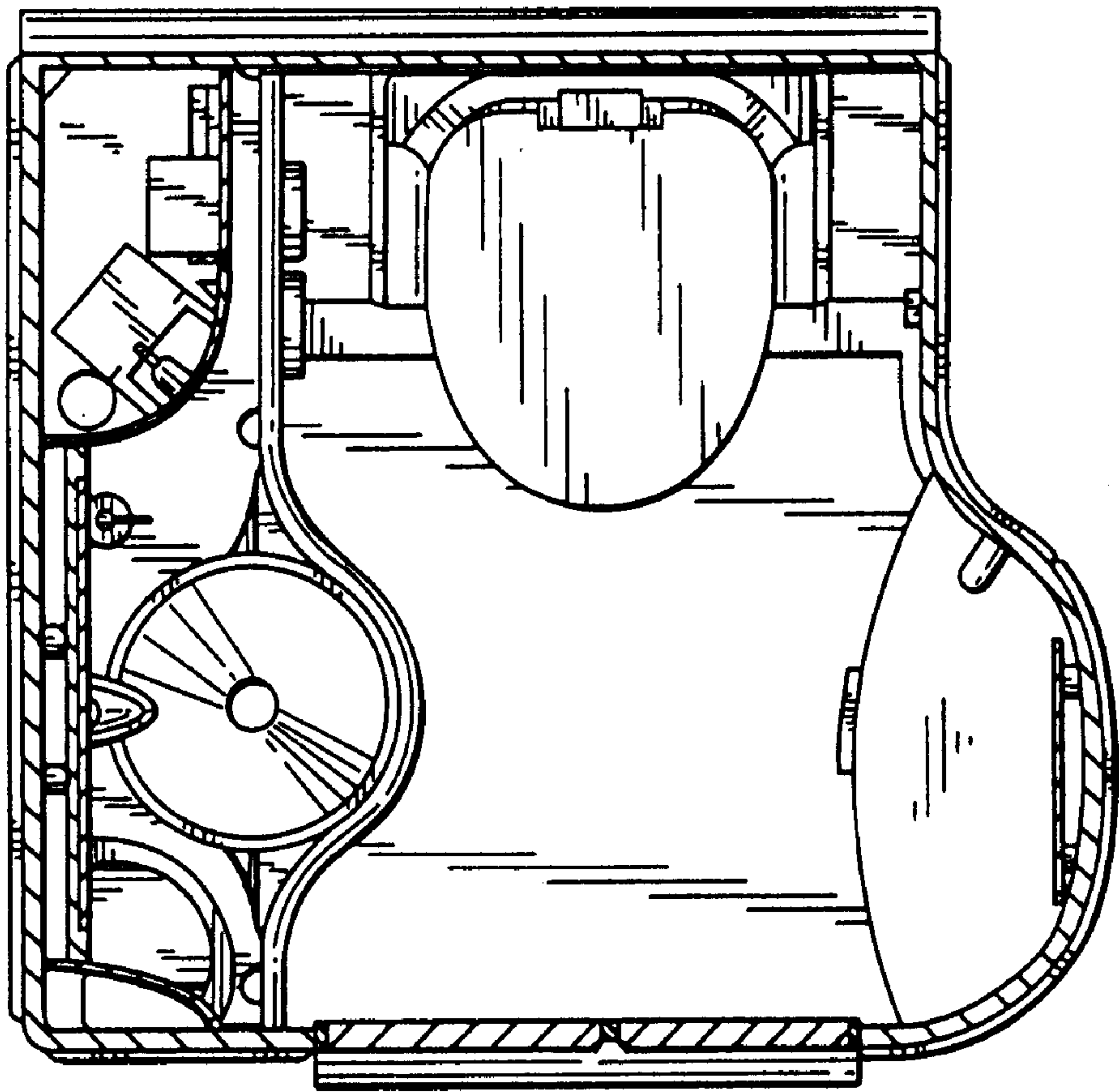

Fig. 13

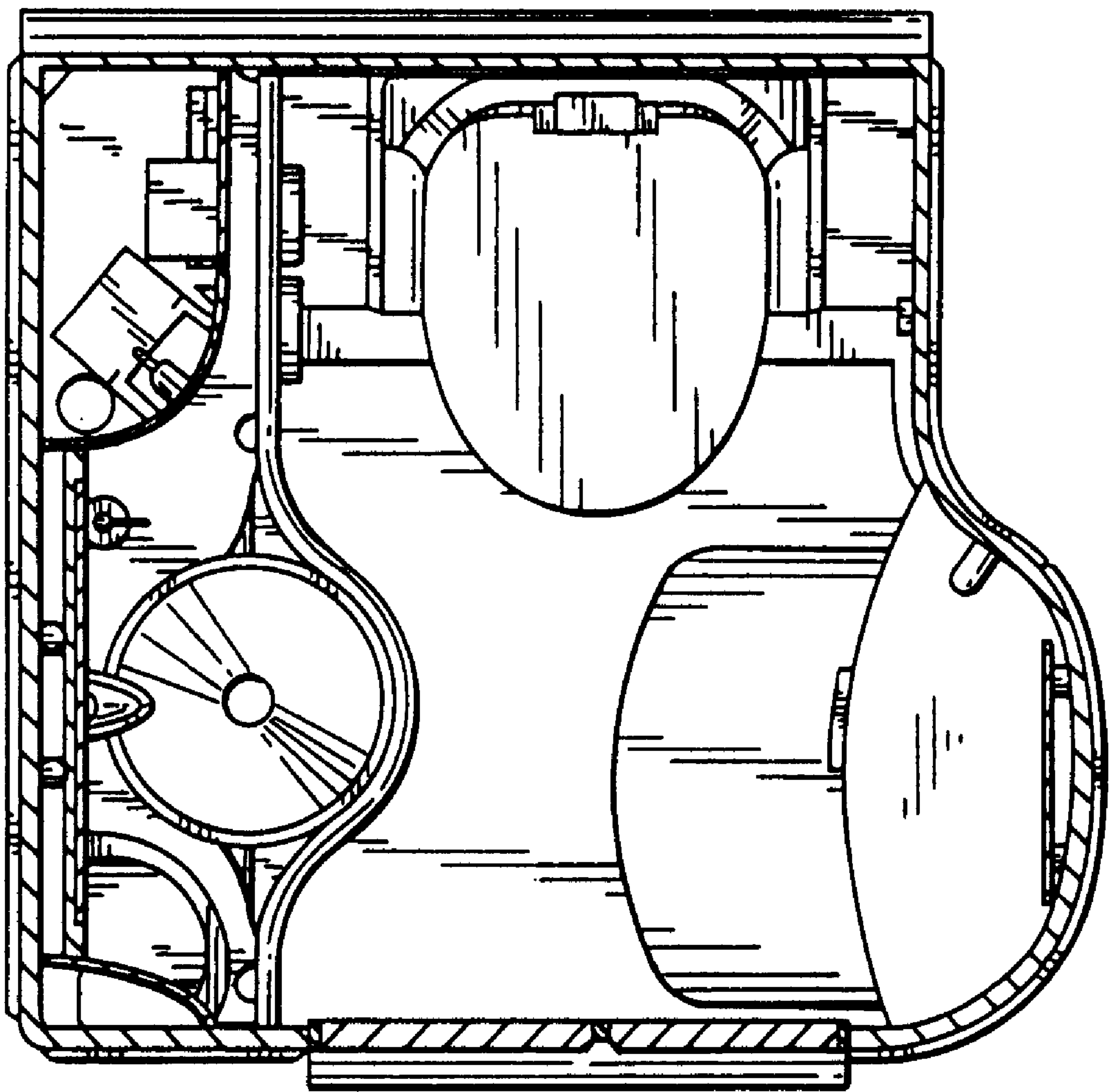



Fig.14

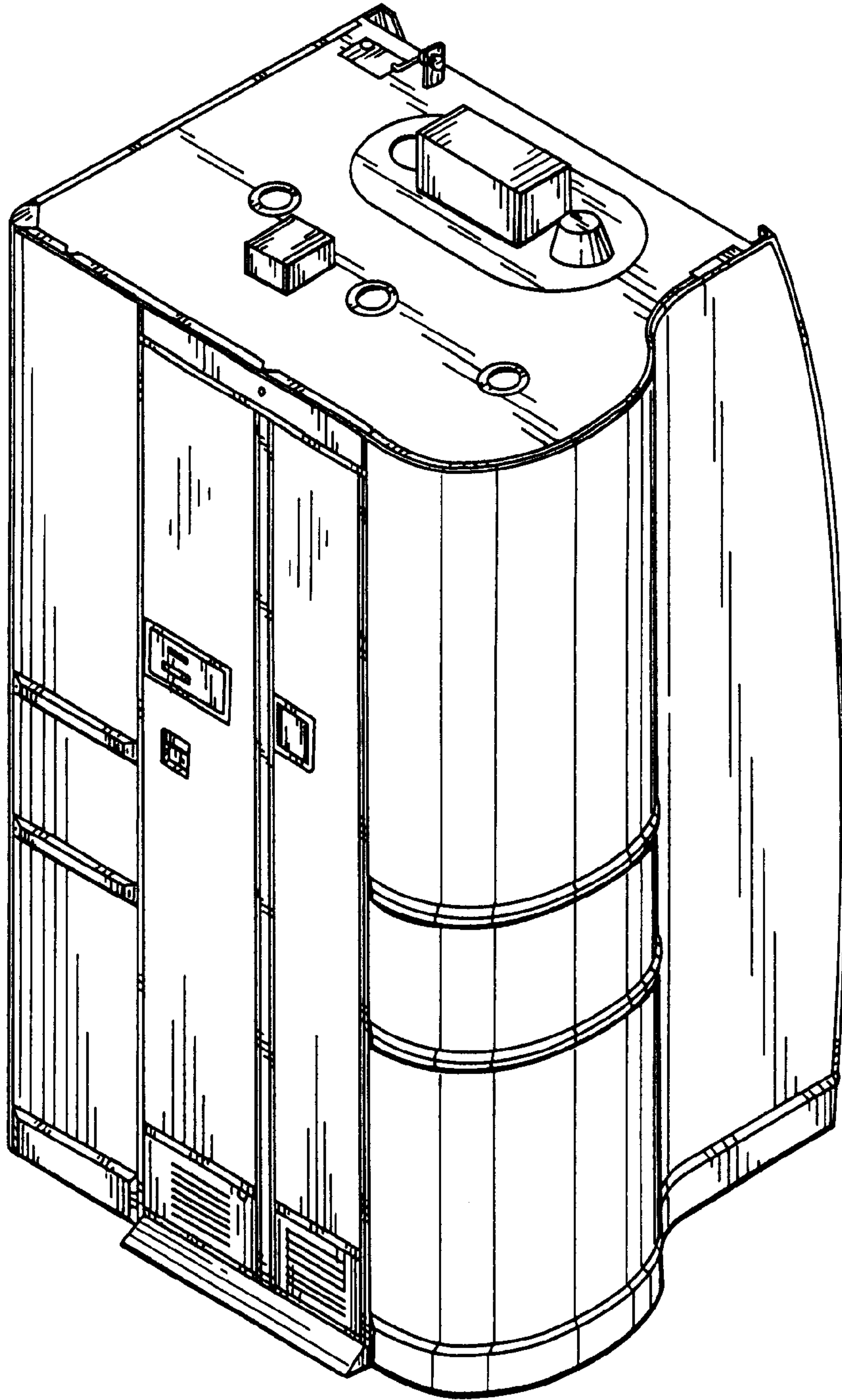



Fig.15

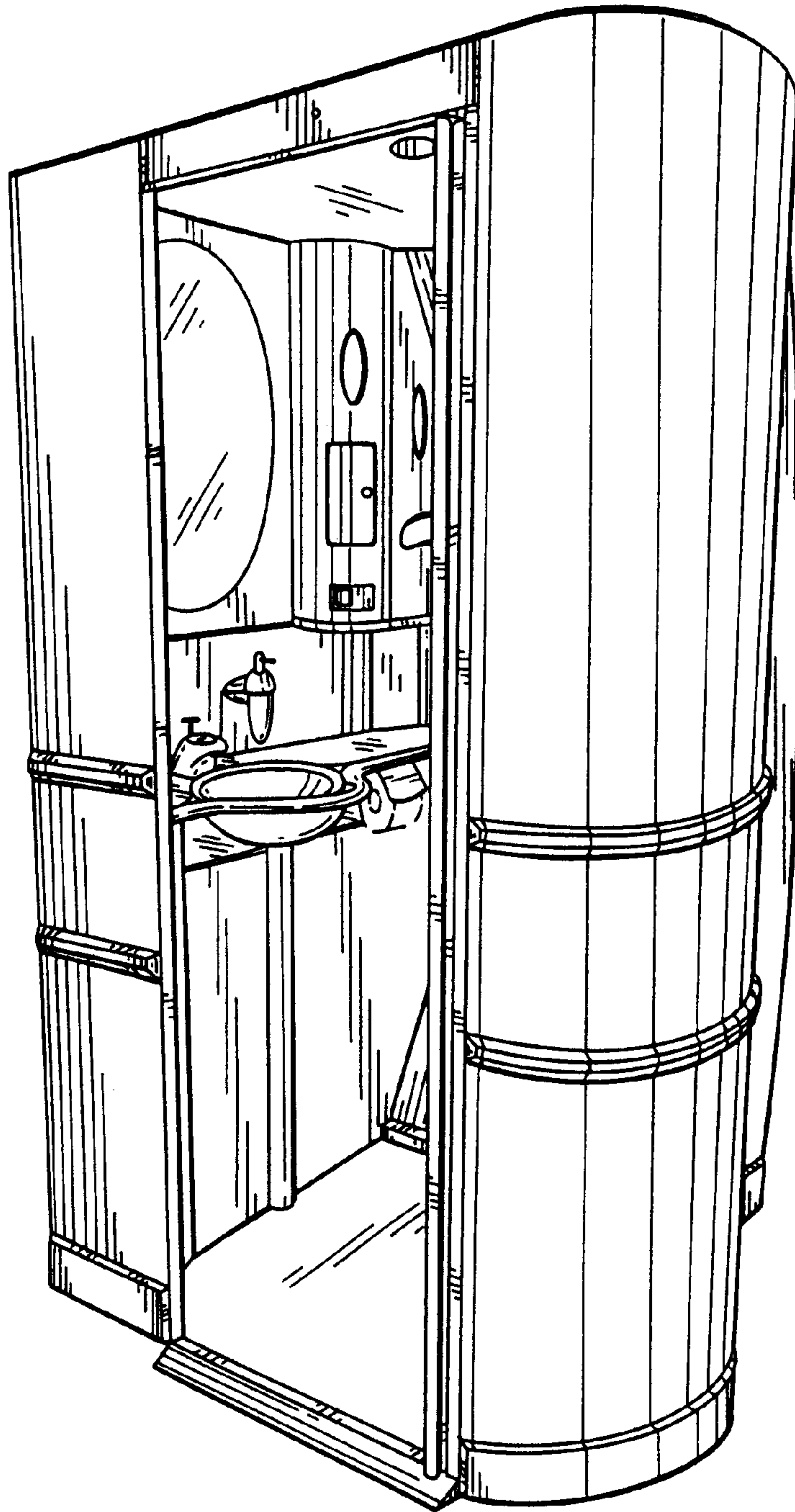

Fig.16

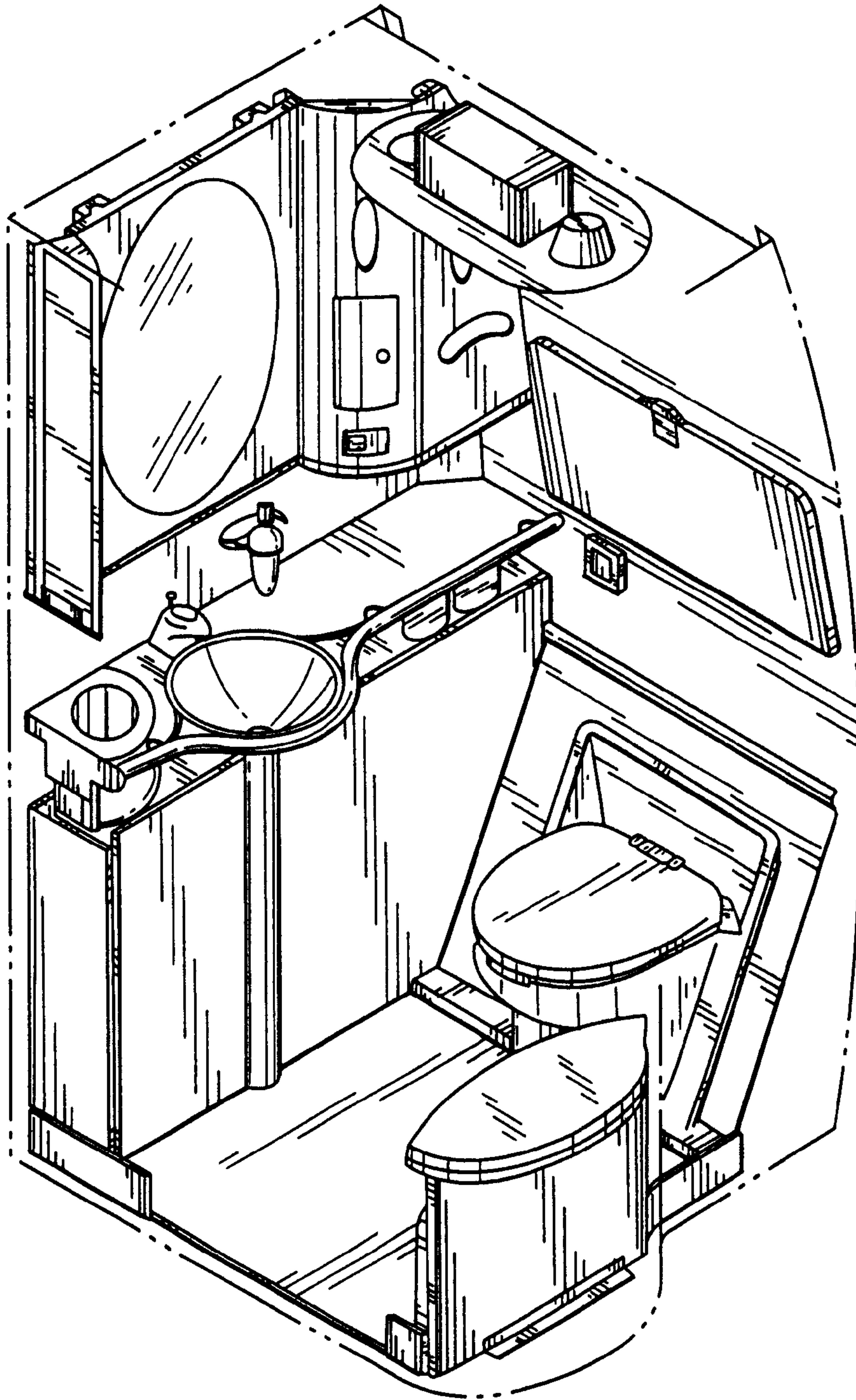

Fig.17

