



US00D487122S

(12) **United States Design Patent**  
**Farris, Jr.**

(10) **Patent No.:** **US D487,122 S**

(45) **Date of Patent:** **\*\* Feb. 24, 2004**

(54) **NECK STRAP AND CHIN CUSHION FOR NECK STABILIZATION DURING SIT-UPS**

(76) **Inventor:** **Wilbert C. Farris, Jr.**, 4445 Cynthia Pl., San Diego, CA (US) 92105

(\*\*) **Term:** **14 Years**

(21) **Appl. No.:** **29/169,090**

(22) **Filed:** **Oct. 15, 2002**

(51) **LOC (7) Cl.** ..... **21-02**

(52) **U.S. Cl.** ..... **D21/662**

(58) **Field of Search** ..... D21/662, 684; 482/140, 131, 139, 74

(56) **References Cited**

**U.S. PATENT DOCUMENTS**

5,267,931	A	*	12/1993	Faetini	.....	482/140
5,295,949	A	*	3/1994	Hathaway	.....	602/18
5,637,067	A	*	6/1997	Ausmus	.....	482/140
5,857,948	A	*	1/1999	Barnett	.....	482/140
5,913,757	A	*	6/1999	Winters	.....	482/140
5,921,903	A	*	7/1999	Lawrence	.....	482/140
5,935,049	A	*	8/1999	Hamm	.....	482/140
6,126,581	A	*	10/2000	Hartsel	.....	482/140
D438,577	S	*	3/2001	Phillips	.....	D21/662

6,319,180 B1 \* 11/2001 Kallassy ..... 482/140

\* cited by examiner

*Primary Examiner*—Philip S. Hyder

(57) **CLAIM**

The ornamental design for a neck strap and chin cushion for neck stabilization during sit-ups, as shown and described.

**DESCRIPTION**

FIG. 1 is a front elevated view of a neck strap and chin cushion for neck stabilization during sit-ups showing my new design;

FIG. 2 is a rear elevated view of the neck strap and chin cushion for neck stabilization during sit-ups;

FIG. 3 is a right side elevated view of the neck strap and chin cushion for neck stabilization during sit-ups;

FIG. 4 is a left side elevated view of the neck strap and chin cushion for neck stabilization during sit-ups;

FIG. 5 is a top plan view of the neck strap and chin cushion for neck stabilization during sit-ups;

FIG. 6 is a bottom plan view of the neck strap and chin cushion for neck stabilization during sit-ups; and,

FIG. 7 is a perspective view of the neck strap and chin cushion showing the arms of the neck strap extending toward each other.

**1 Claim, 4 Drawing Sheets**

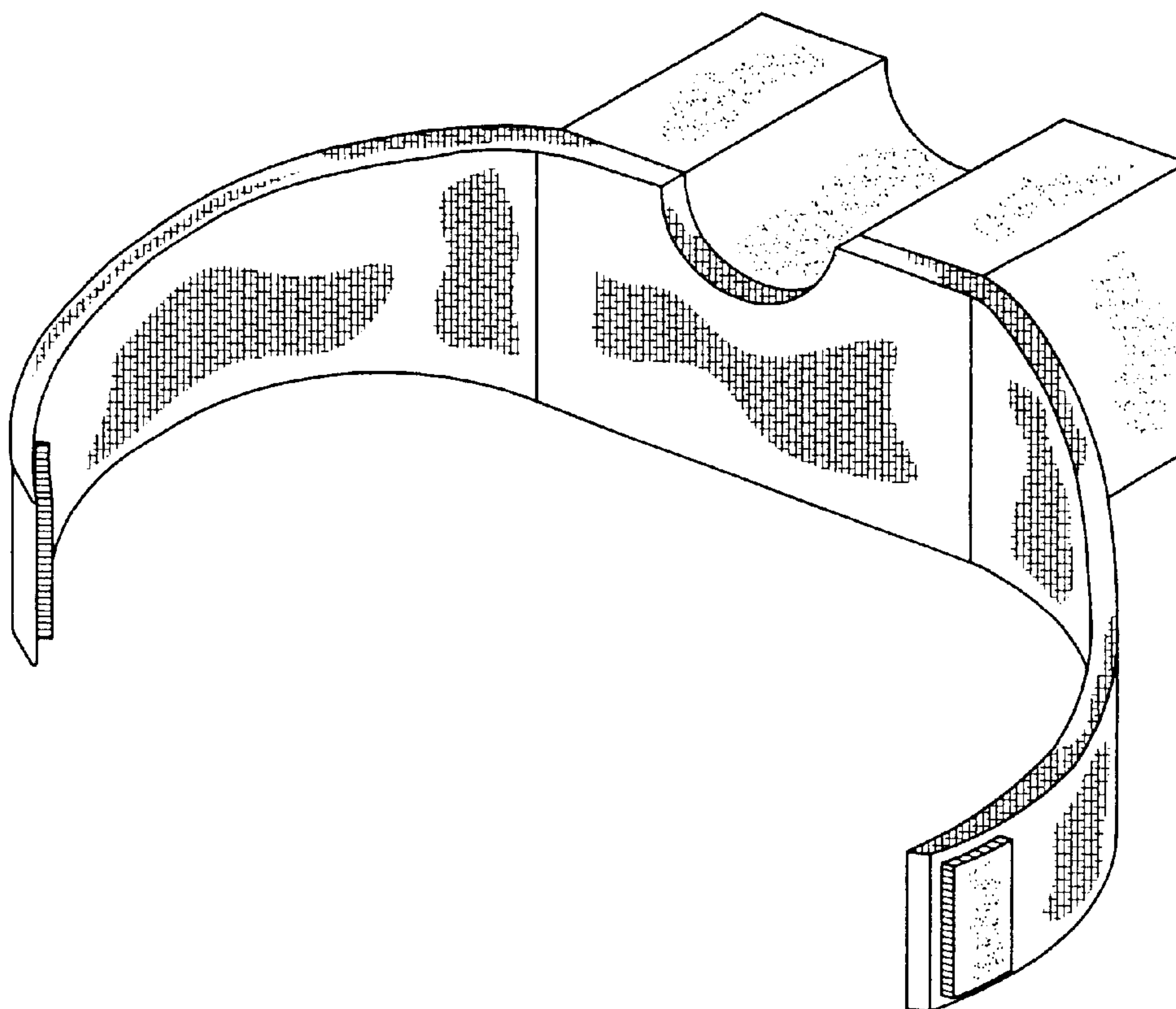

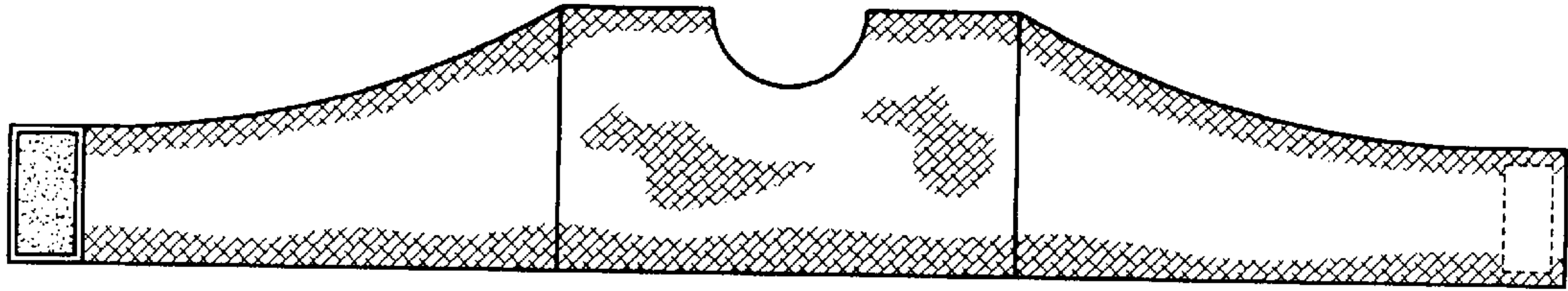

FIG. 1

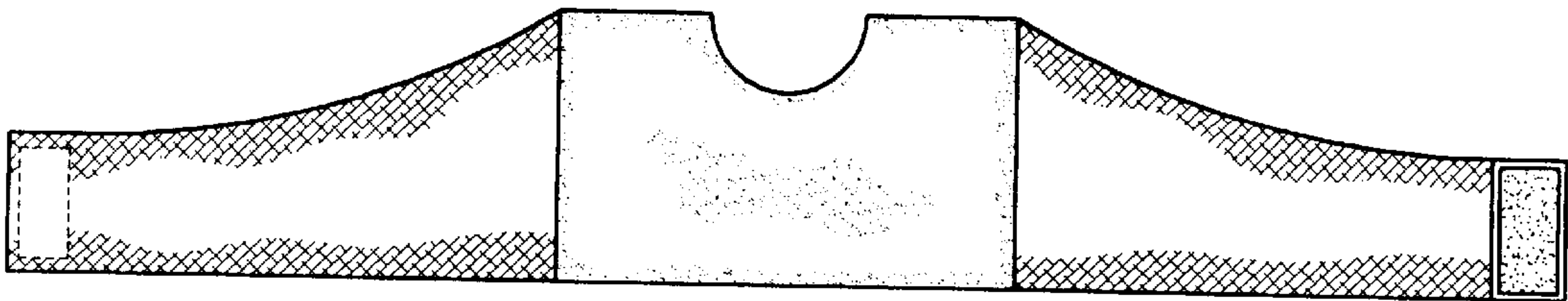

FIG. 2

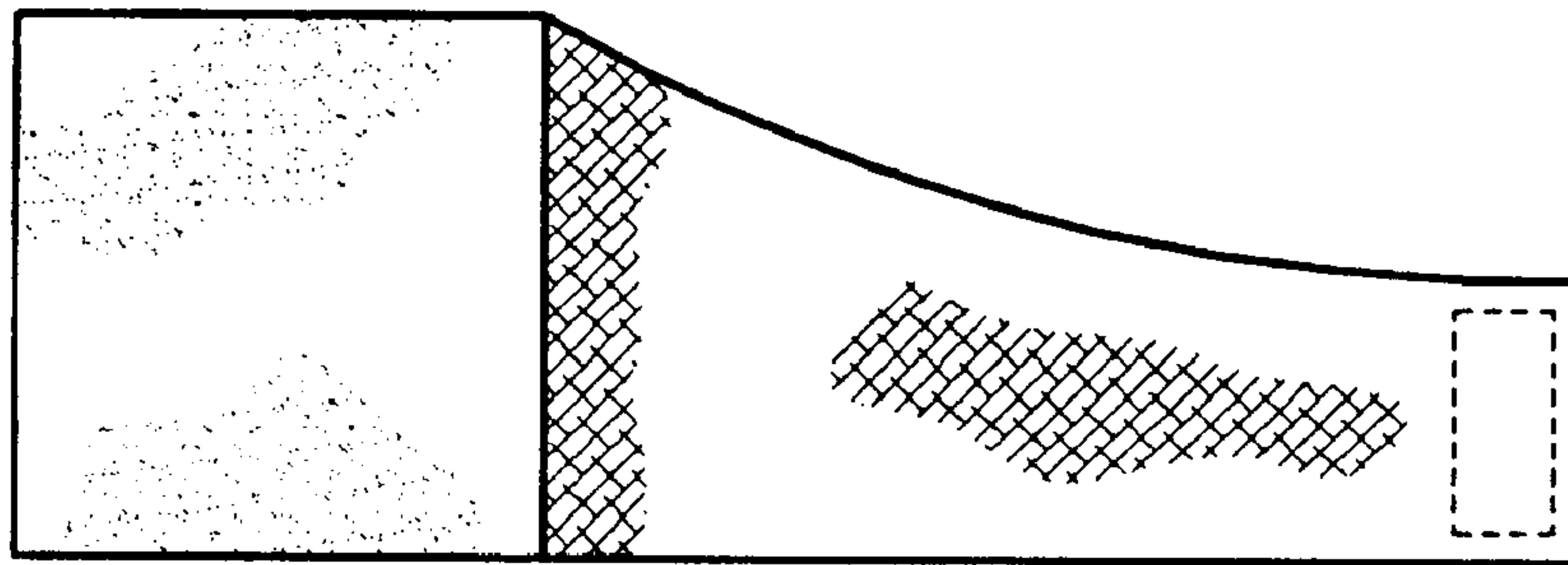

FIG.3

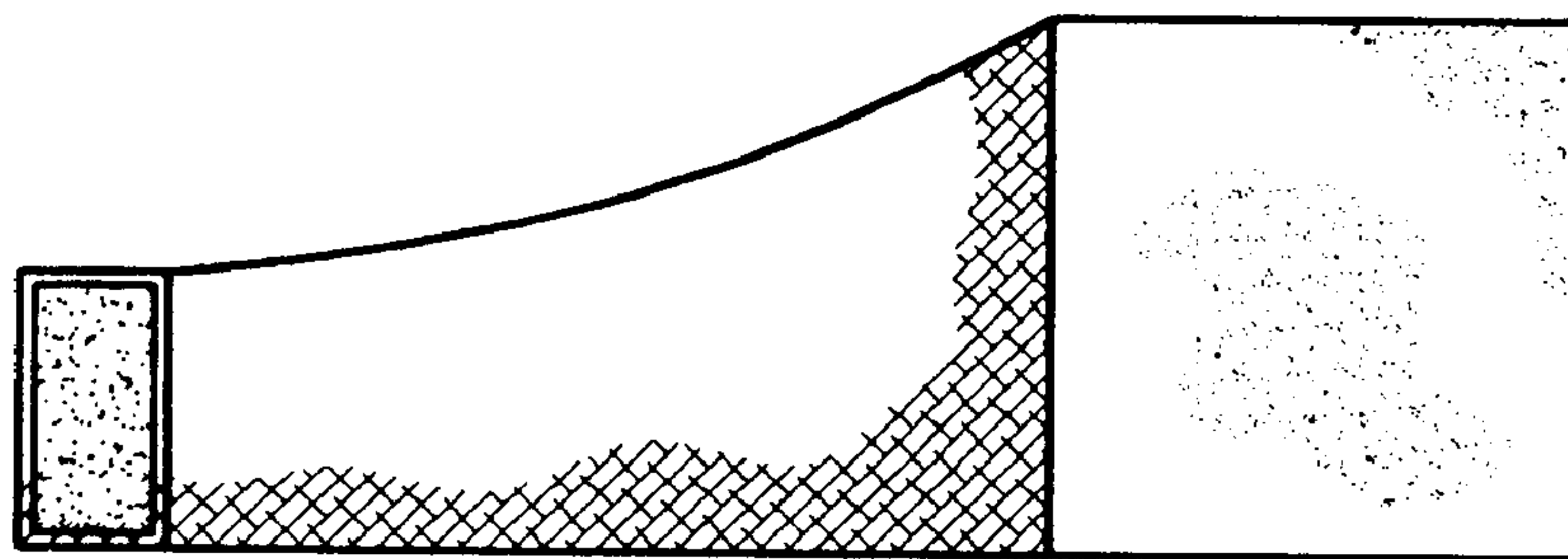

FIG.4

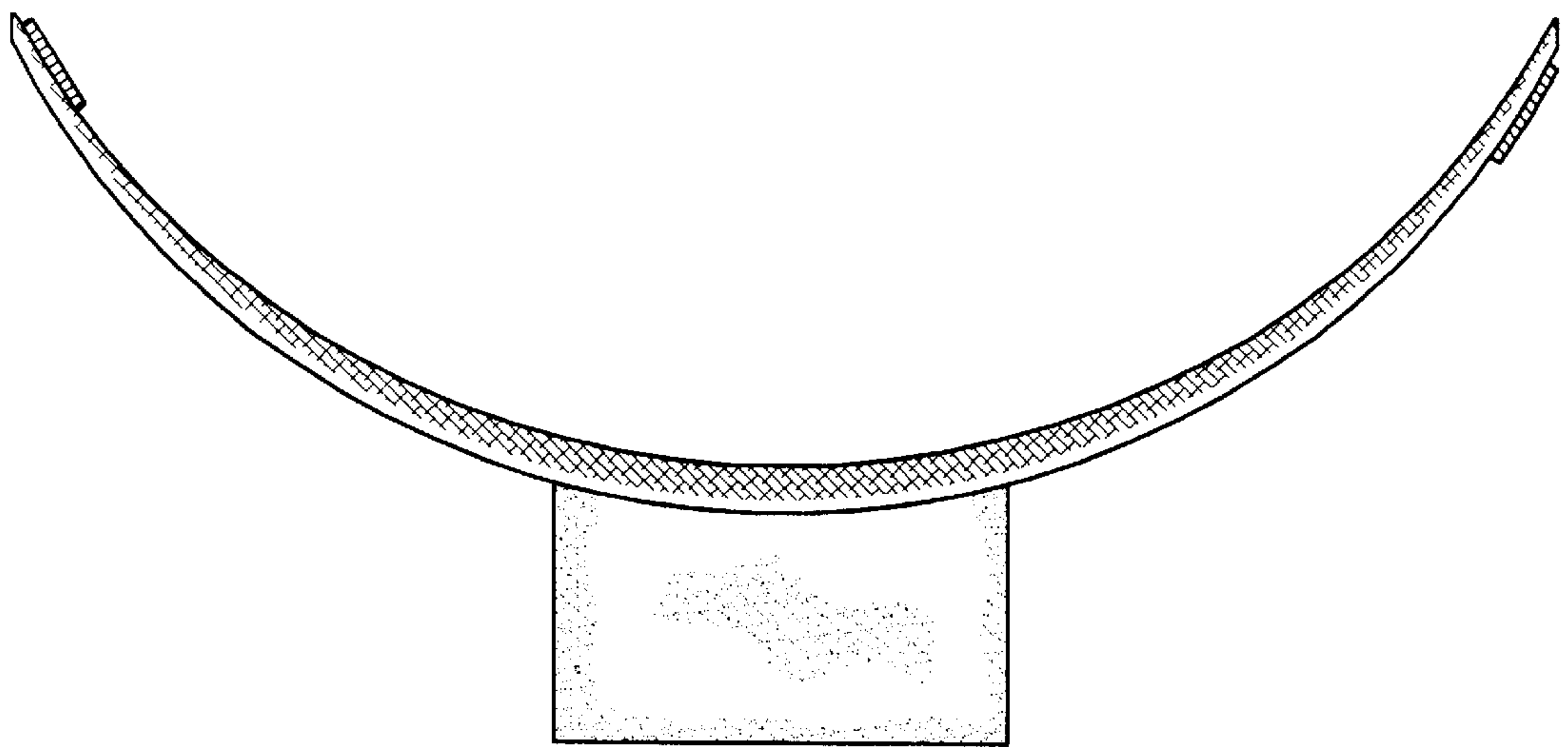
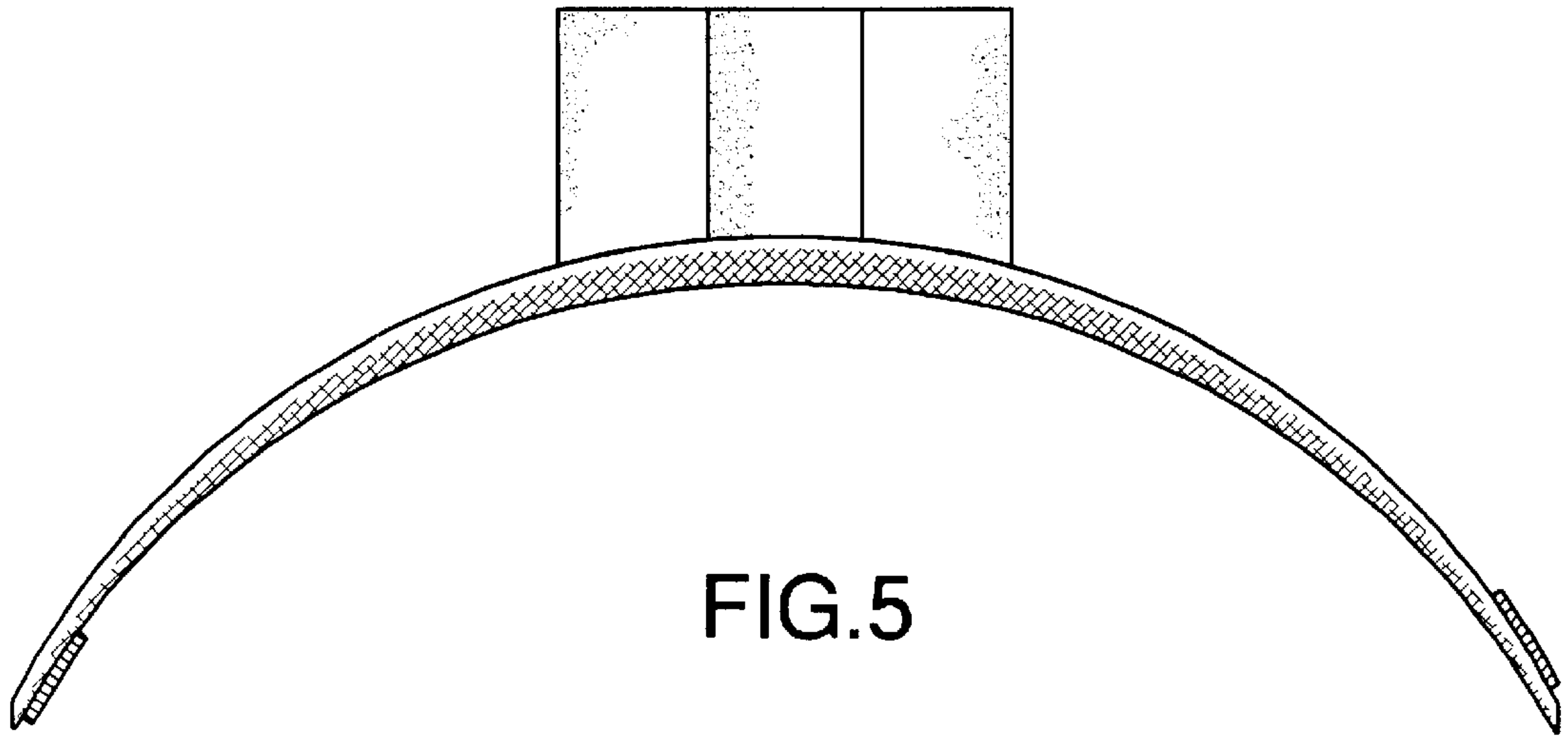

FIG. 6

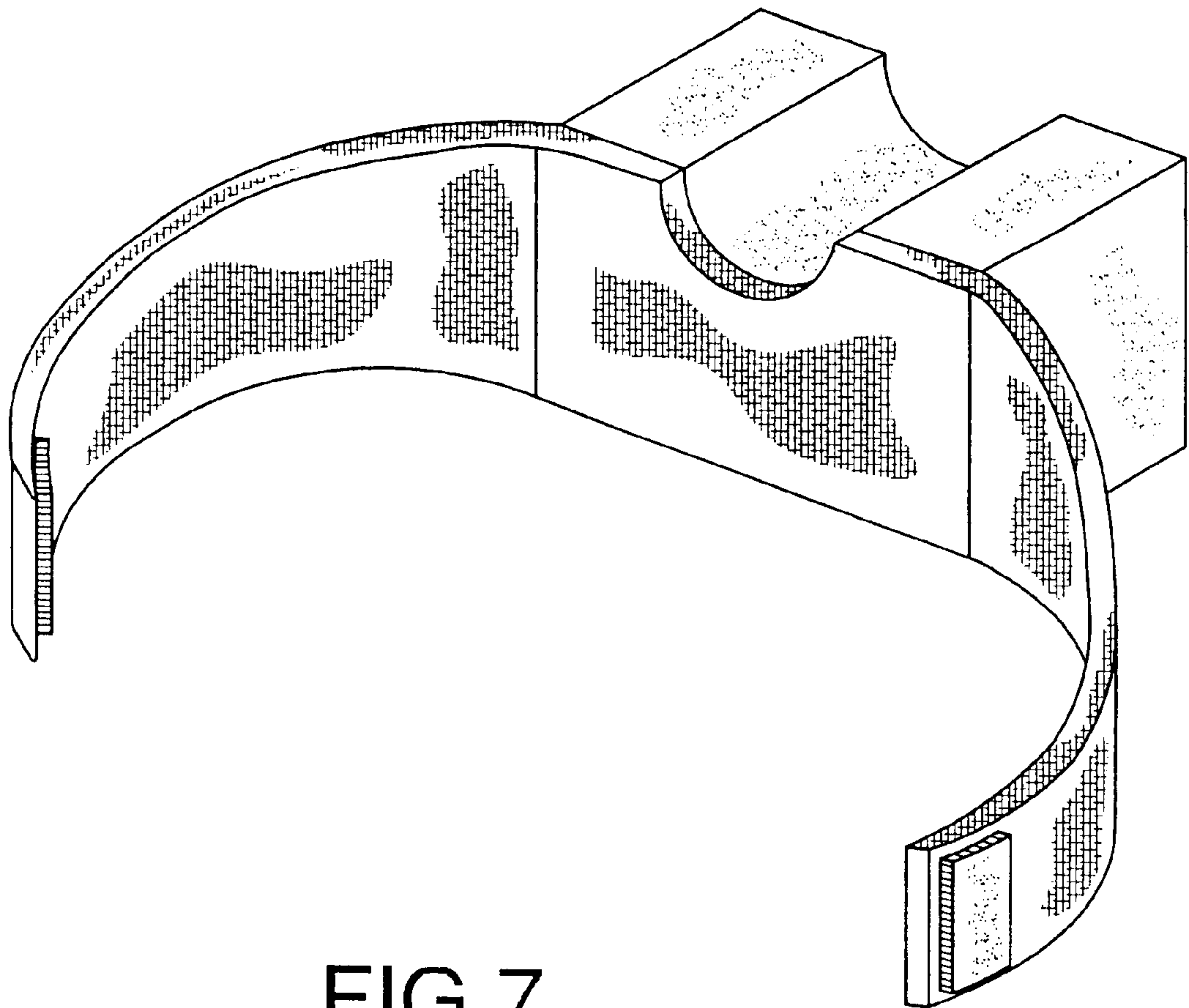

FIG.7