



US00D487017S

(12) **United States Design Patent**
Kurumada et al.

(10) **Patent No.:** **US D487,017 S**

(45) **Date of Patent:** **** Feb. 24, 2004**

(54) **CONTAINER**

(75) Inventors: **Toshiki Kurumada, Osaka (JP);**
Takayuki Kodama, Osaka (JP)

(73) Assignee: **Rohto Pharmaceutical Co., Ltd.,**
Osaka (JP)

(**) Term: **14 Years**

(21) Appl. No.: **29/158,363**

(22) Filed: **Apr. 2, 2002**

(30) **Foreign Application Priority Data**

Oct. 16, 2001 (JP) 2001-030379
Oct. 16, 2001 (JP) 2001-030380

(51) **LOC (7) Cl.** **09-01**

(52) **U.S. Cl.** **D9/503; D9/502**

(58) **Field of Search** D9/500, 502, 503,
D9/504, 515, 516, 549, 557, 558, 300,
446, 447, 449, 450, 454; 215/382-384,
396, 398, 400

(56) **References Cited**

U.S. PATENT DOCUMENTS

D177,761 S * 5/1956 Reinhardt D9/503
D193,955 S * 10/1962 Alexander D9/450 X
D221,275 S * 7/1971 Hebblethwaite D9/300

D224,508 S * 8/1972 Newby D9/300
D250,394 S * 11/1978 Menius D9/502
D279,354 S * 6/1985 Marcus D9/502
D288,130 S * 2/1987 Larkin et al. D24/224
D289,858 S * 5/1987 Duval et al. D9/529
D410,821 S * 6/1999 Huang D9/502 X
D456,256 S * 4/2002 Paczosa D9/435

* cited by examiner

Primary Examiner—Nanda Bondade

Assistant Examiner—Carol Rademaker

(74) *Attorney, Agent, or Firm*—Jordan and Hamburg LLP

(57) **CLAIM**

The ornamental design for a container, as shown and described.

DESCRIPTION

FIG. 1 is a perspective view of a container showing our new design;

FIG. 2 is a front view thereof;

FIG. 3 is a rear view thereof;

FIG. 4 is a left side view thereof;

FIG. 5 is a right side view thereof;

FIG. 6 is a top view thereof; and,

FIG. 7 is a bottom view thereof.

Portions shown in broken lines are shown for illustrative purposes only and form no part of the claimed design.

1 Claim, 3 Drawing Sheets

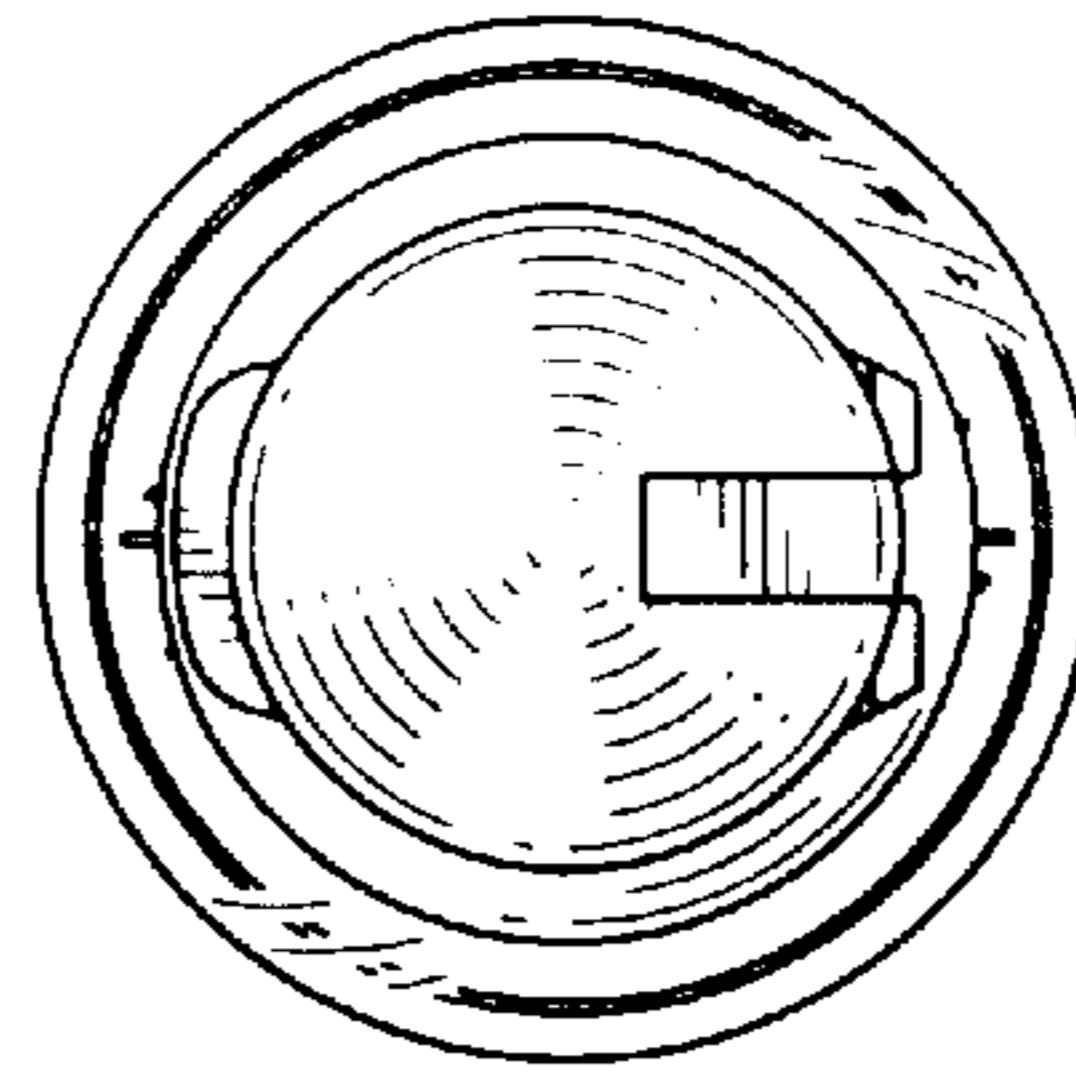
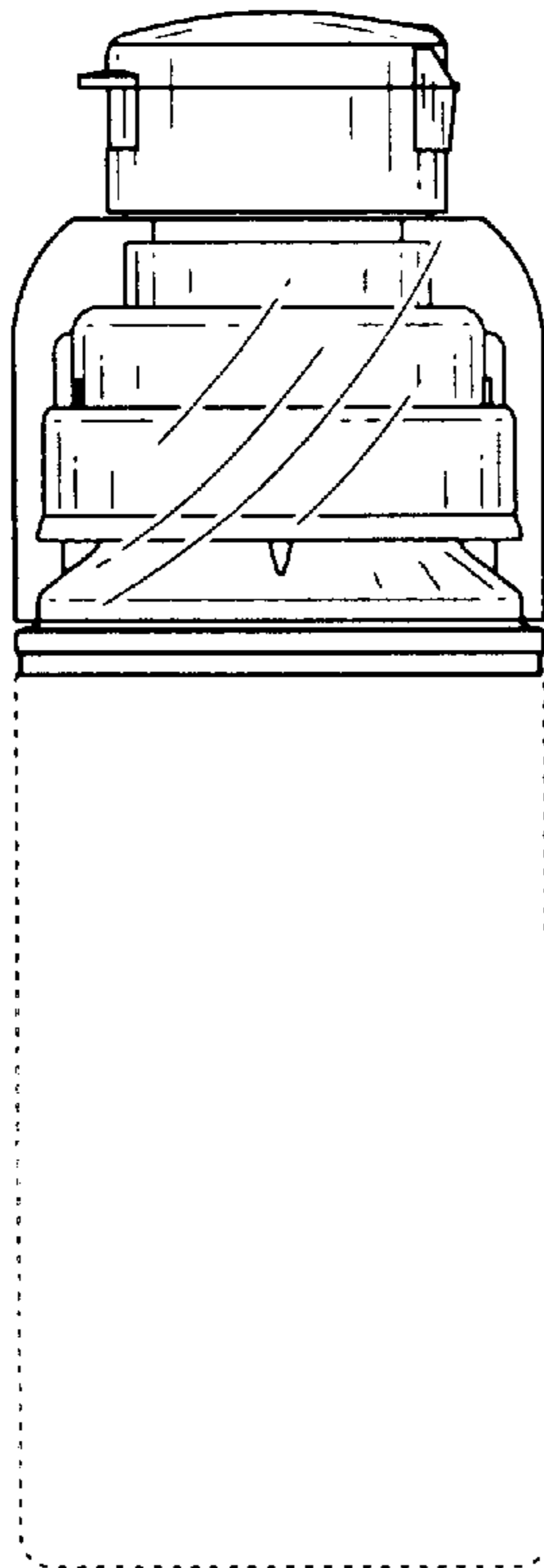

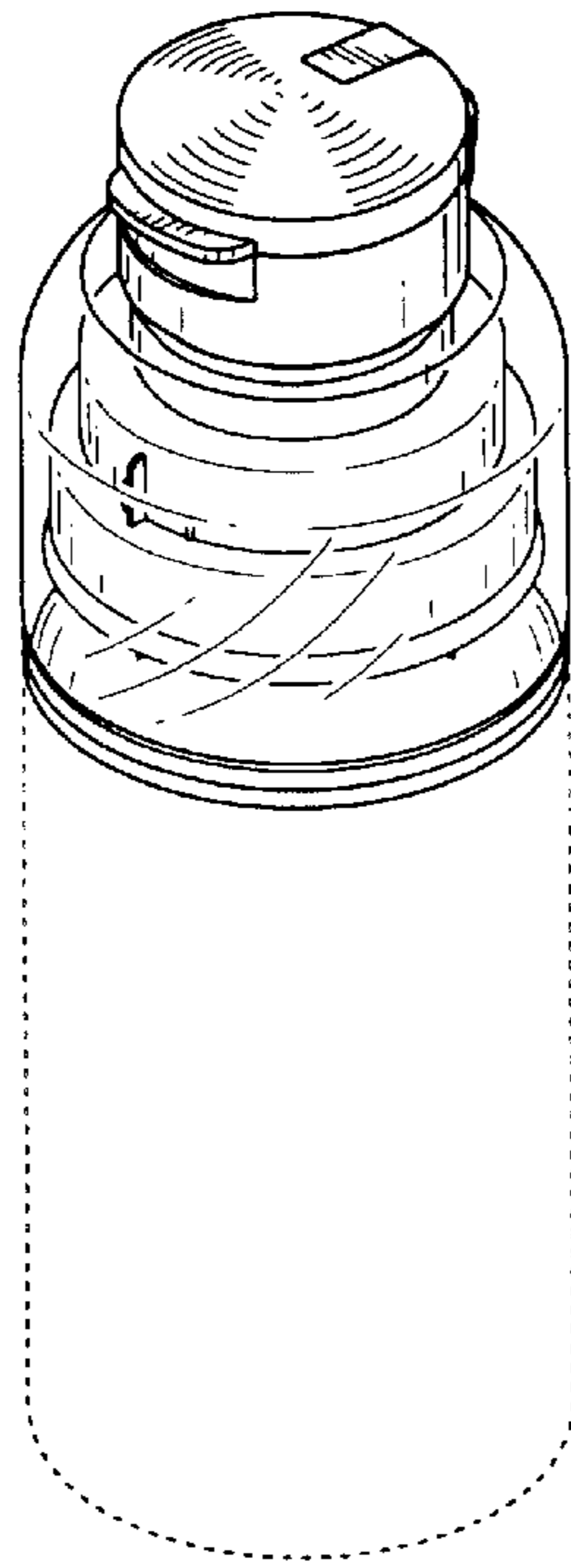

FIG. 1

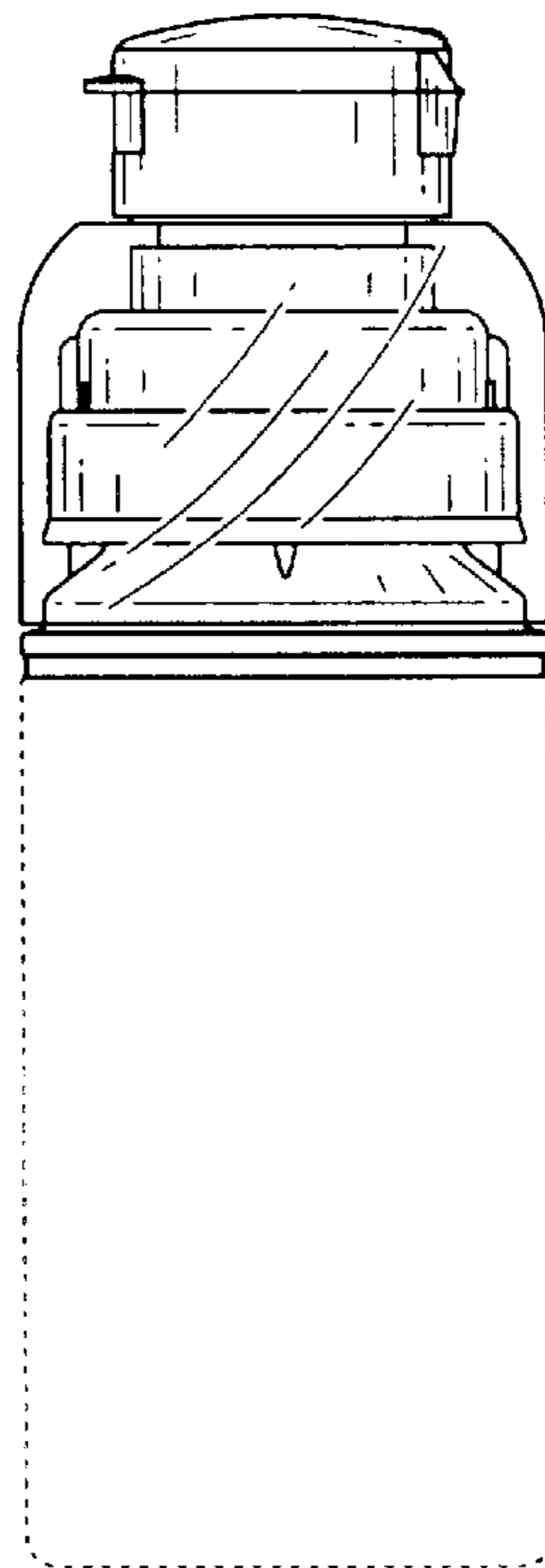

FIG. 2

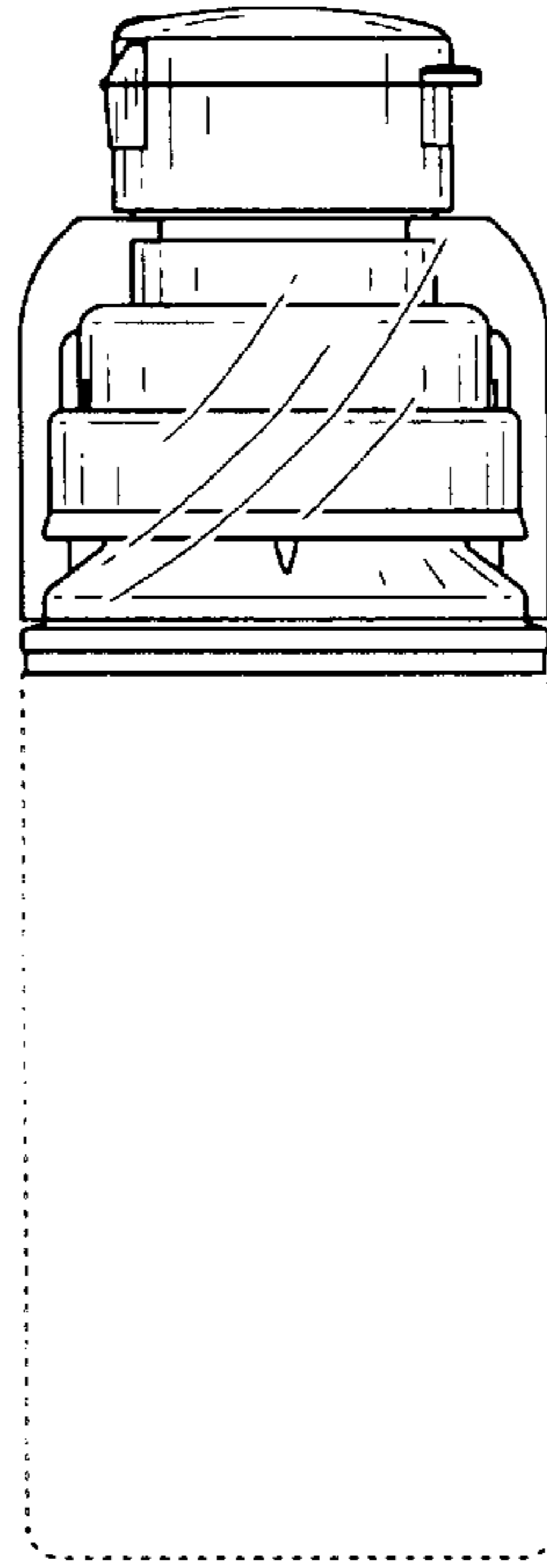

FIG. 3

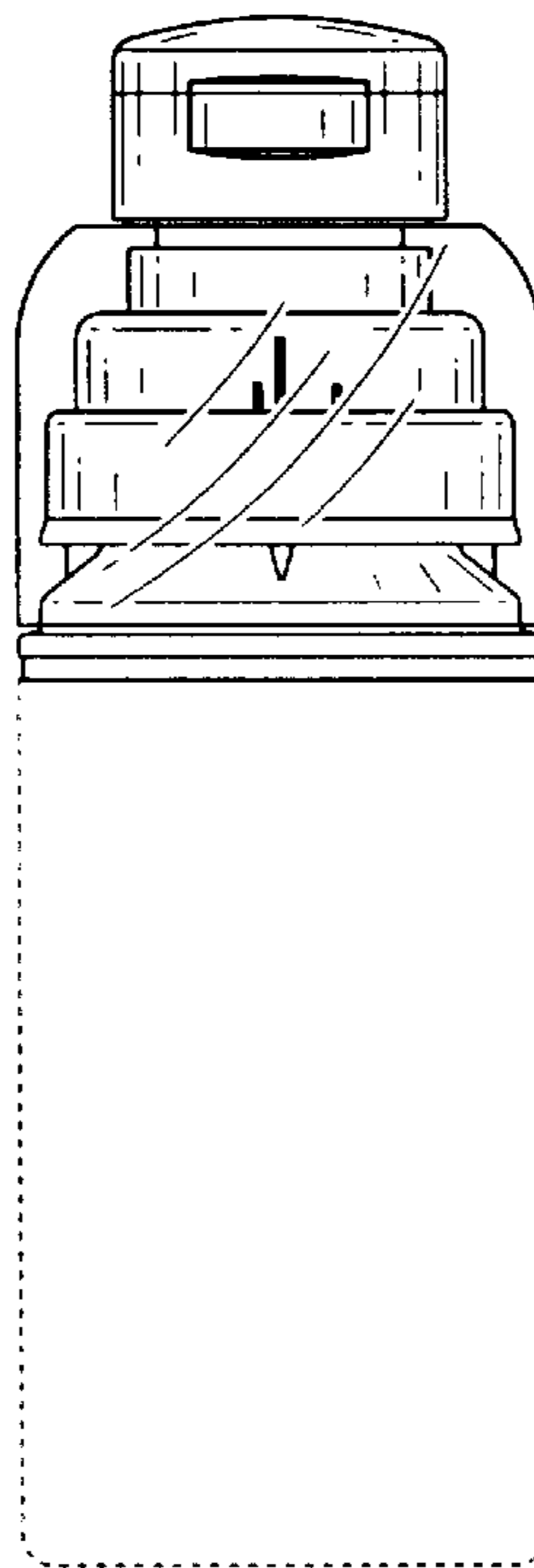

FIG. 4

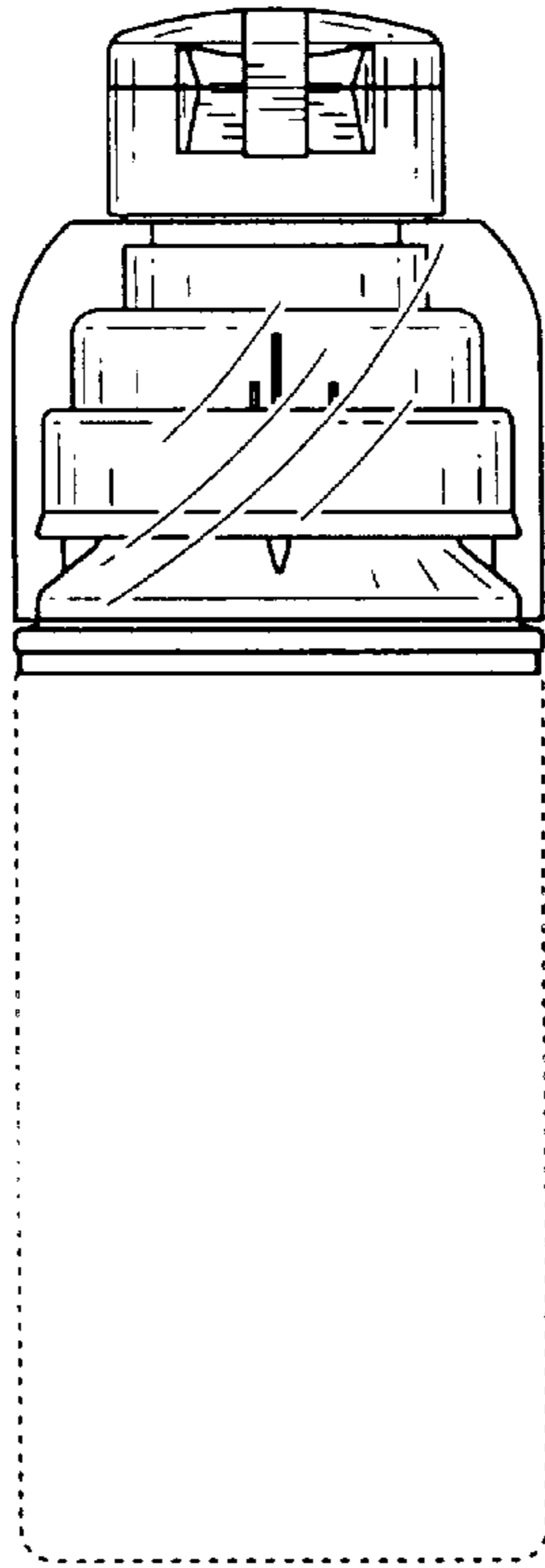

FIG. 5

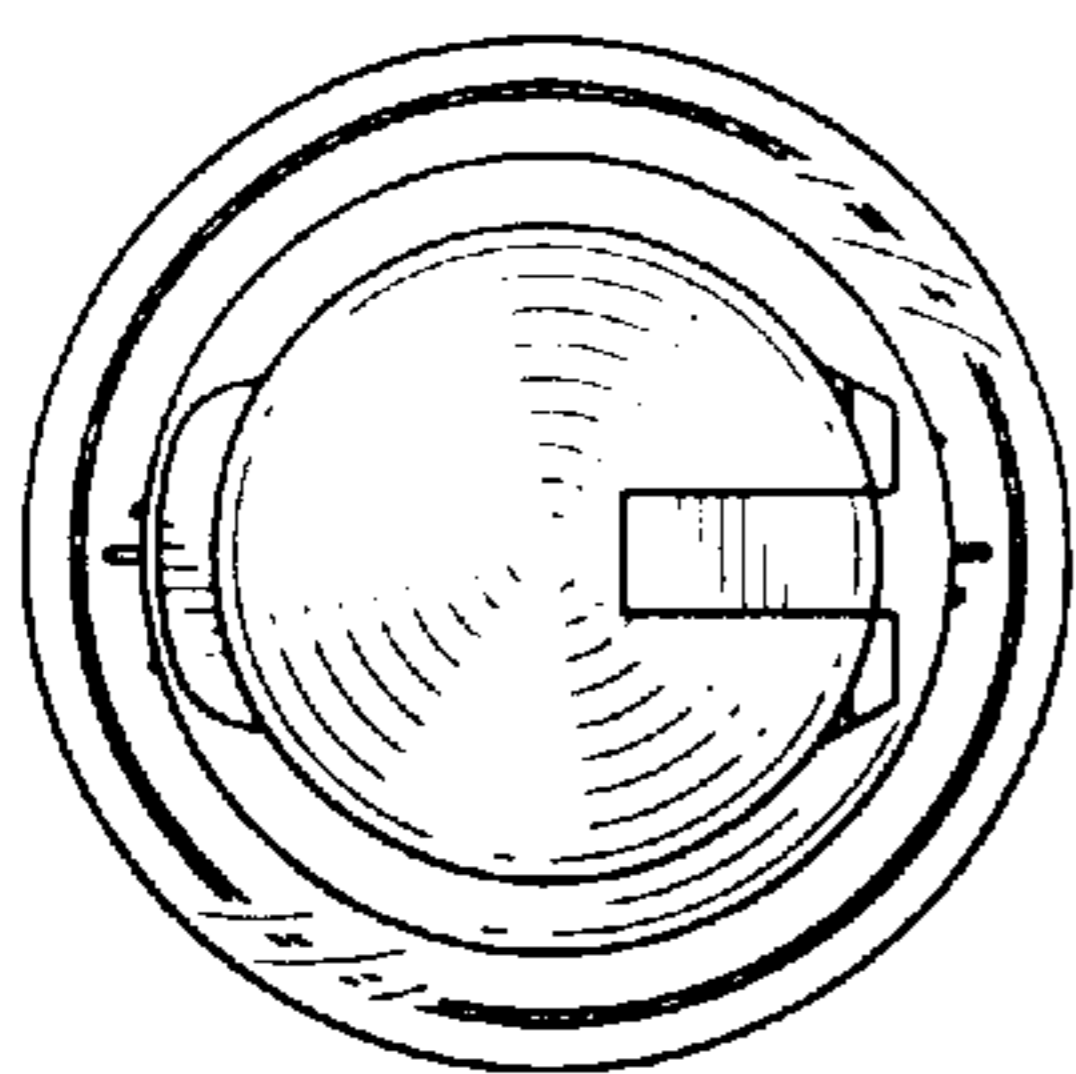

FIG. 6

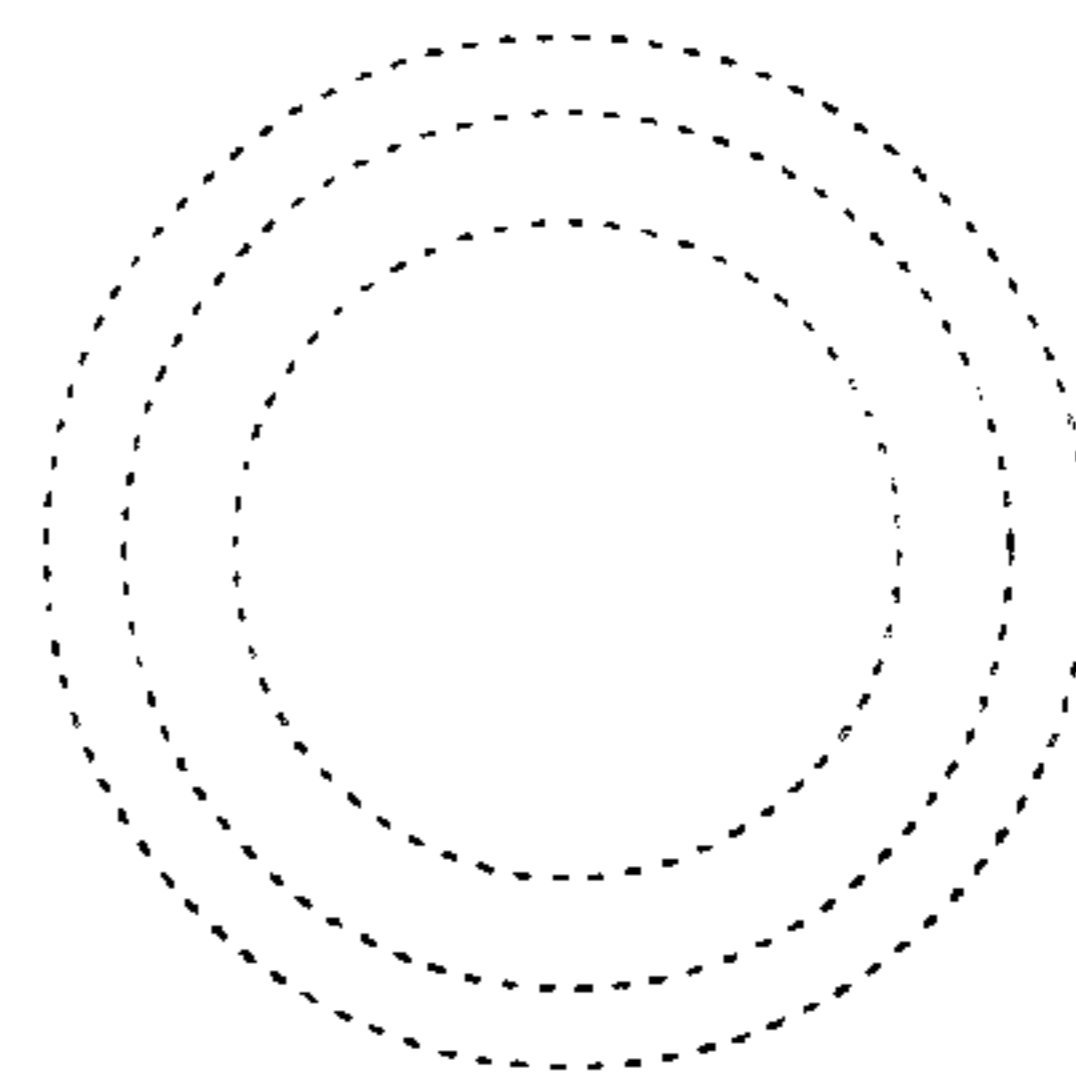

FIG. 7