



US00D486973S

(12) **United States Design Patent**
Tseng

(10) **Patent No.:** **US D486,973 S**

(45) **Date of Patent:** **** Feb. 24, 2004**

(54) **LAWN CHAIR**

(75) **Inventor:** **Chuen-Jong Tseng, Chiayi Hsien (TW)**

(73) **Assignee:** **Shin Yeh Enterprise Co., Ltd., Chiayi Hsien (TW)**

(**) **Term:** **14 Years**

(21) **Appl. No.:** **29/178,898**

(22) **Filed:** **Apr. 2, 2003**

(51) **LOC (7) Cl.** **06-01**

(52) **U.S. Cl.** **D6/376; D6/379**

(58) **Field of Search** **D6/334, 374, 375, D6/376, 379, 380, 500, 501, 502; 297/445.1, 446.1**

(56) **References Cited**

U.S. PATENT DOCUMENTS

D341,266 S	*	11/1993	Caldwell	D6/376
D373,031 S	*	8/1996	Martin	D6/376
D408,644 S	*	4/1999	Muller	D6/376
D426,975 S	*	6/2000	Gaylord et al.	D6/376

D434,241 S * 11/2000 Tseng D6/376

D440,065 S * 4/2001 Goodman D6/376

D450,197 S * 11/2001 Lin D6/376

D454,716 S * 3/2002 Tseng D6/379

D463,153 S * 9/2002 Liu D6/379

* cited by examiner

Primary Examiner—Gary D. Watson

(74) *Attorney, Agent, or Firm*—Ladas & Parry

(57) **CLAIM**

The ornamental design for lawn chair, as shown and described.

DESCRIPTION

FIG. 1 is a perspective view of lawn chair showing my new design;

FIG. 2 is a front elevational view thereof;

FIG. 3 is a rear elevational view thereof;

FIG. 4 is a left side elevational view thereof;

FIG. 5 is a right side elevational view thereof;

FIG. 6 is a top plan view thereof; and,

FIG. 7 is a bottom plan view thereof.

1 Claim, 4 Drawing Sheets

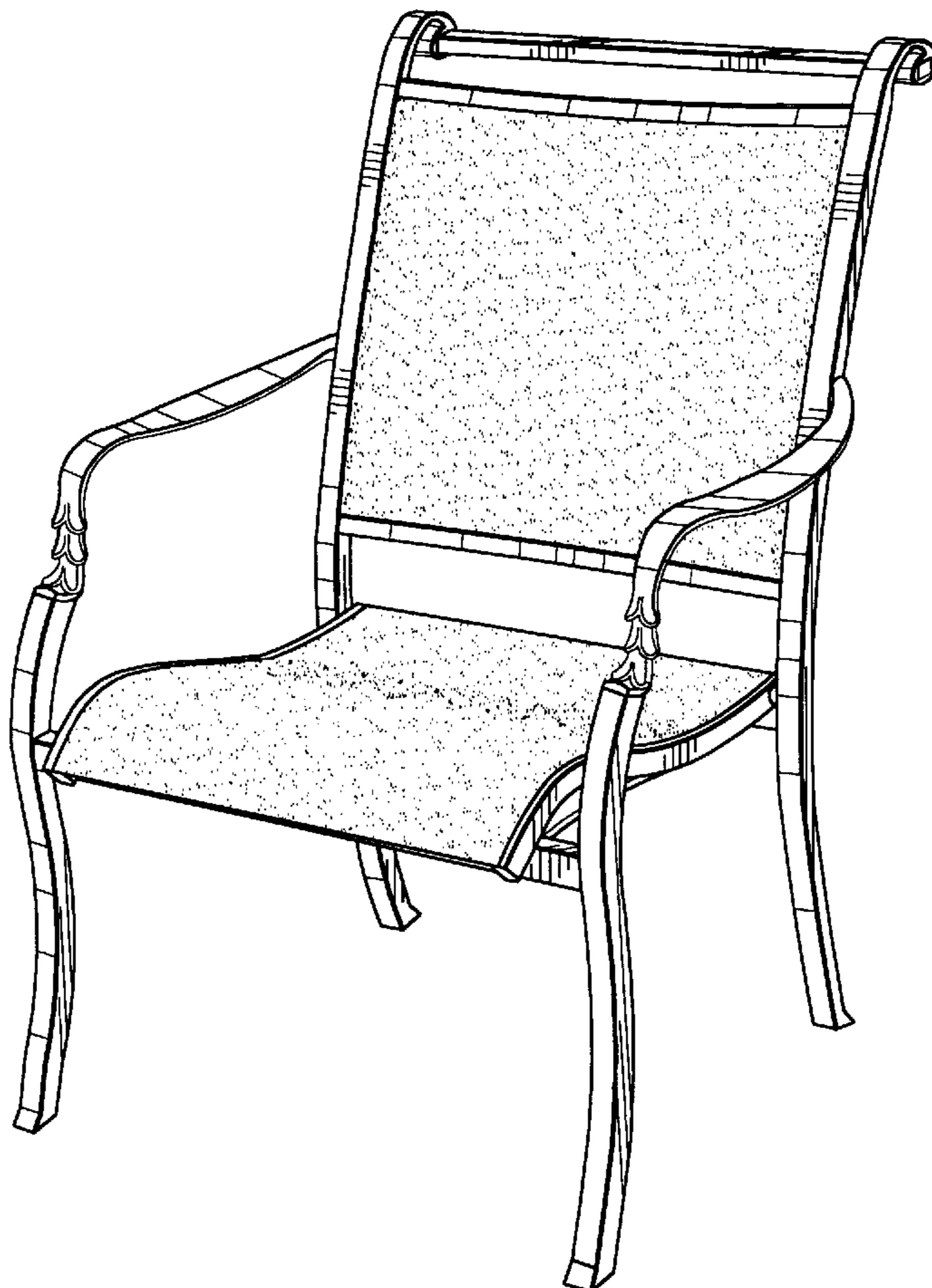

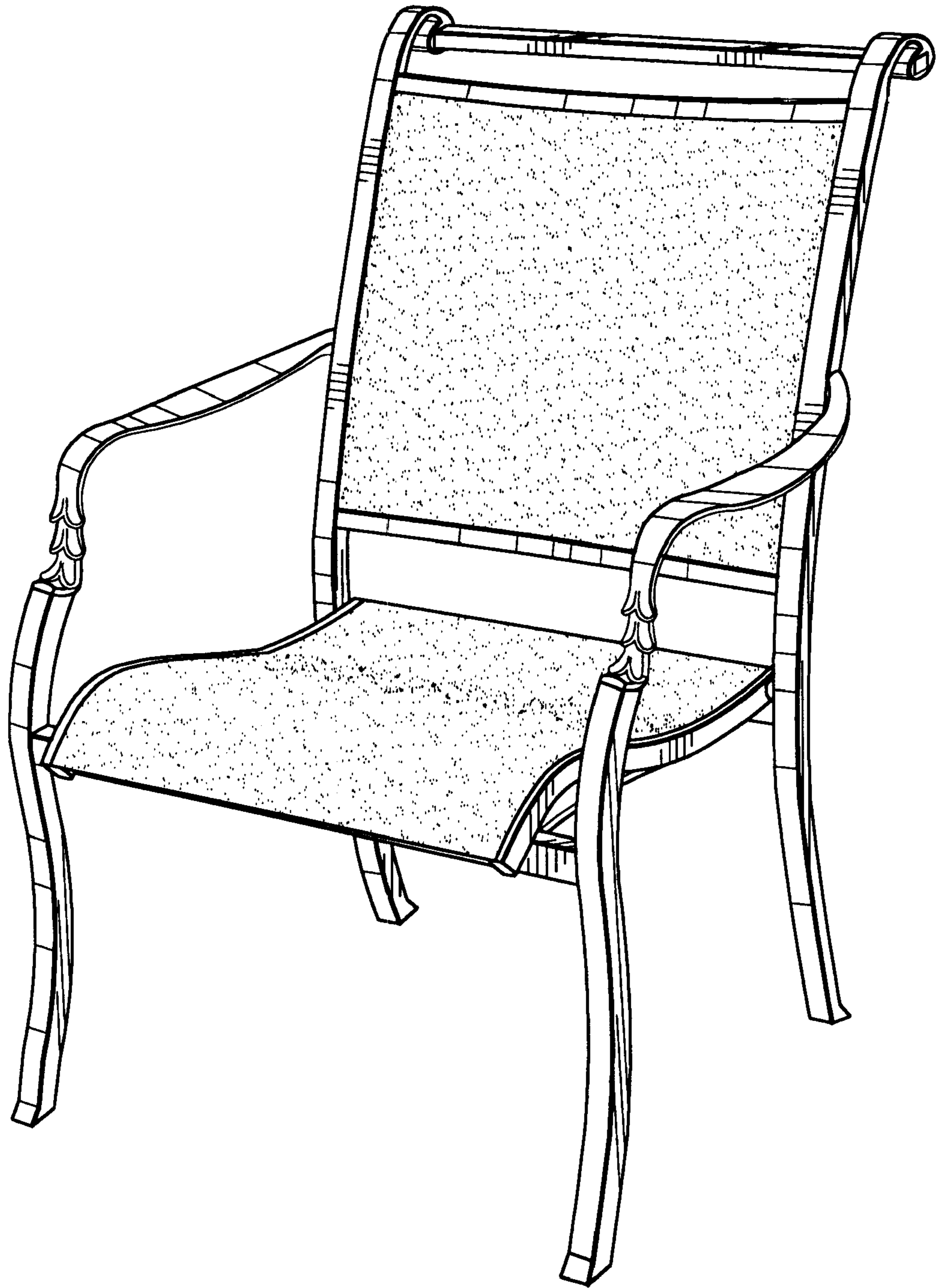

FIG. 1

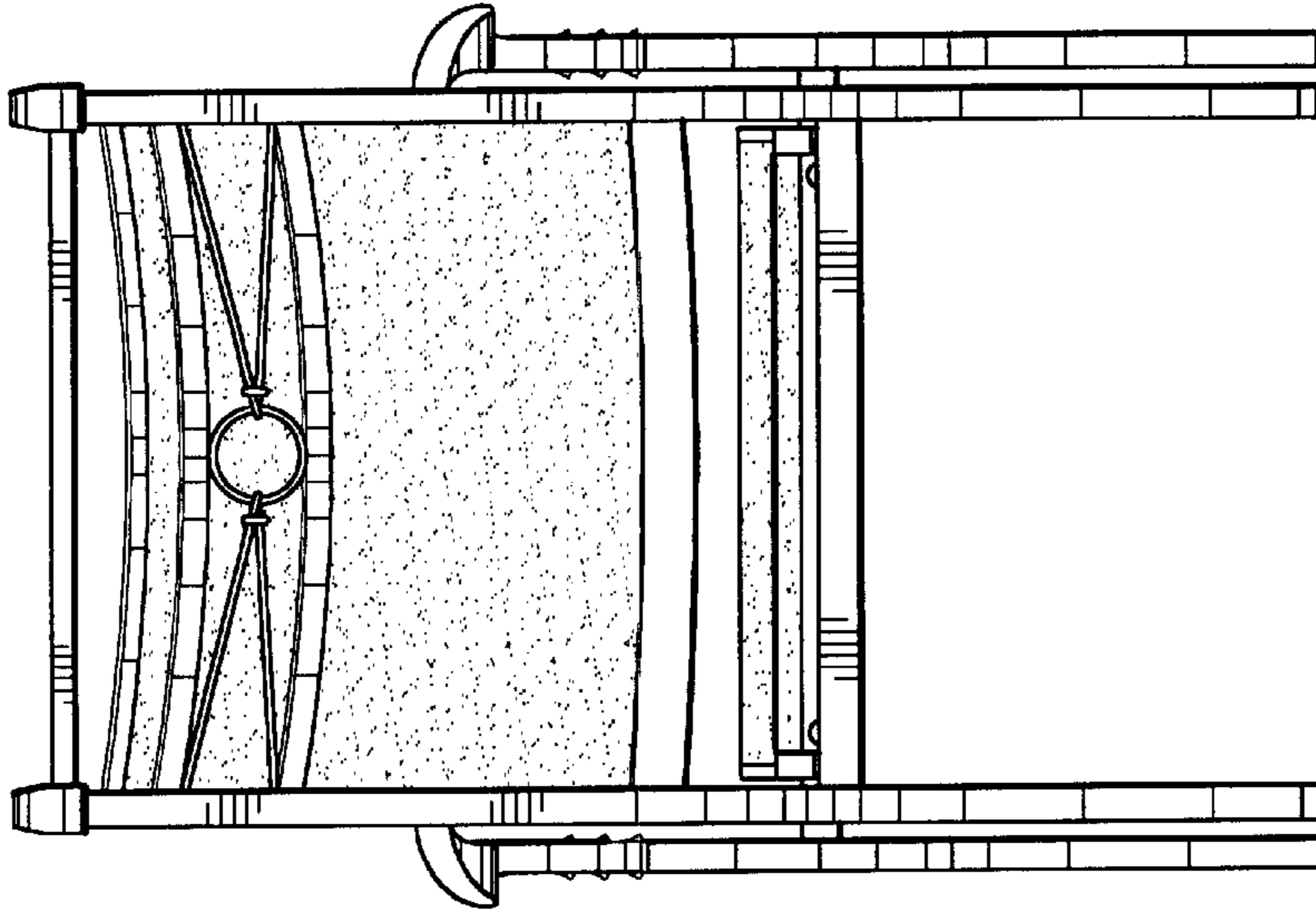

FIG. 2

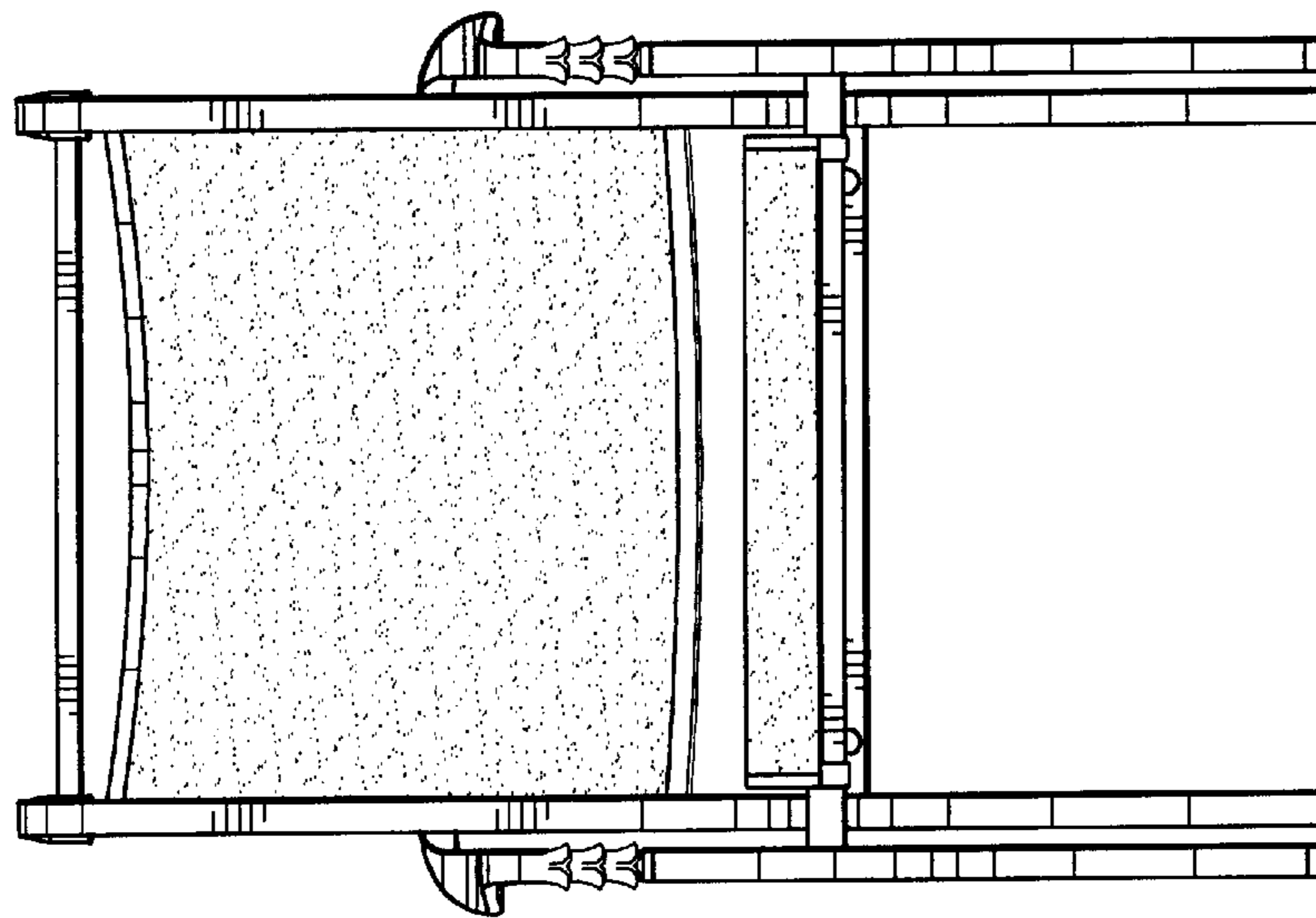

FIG. 3

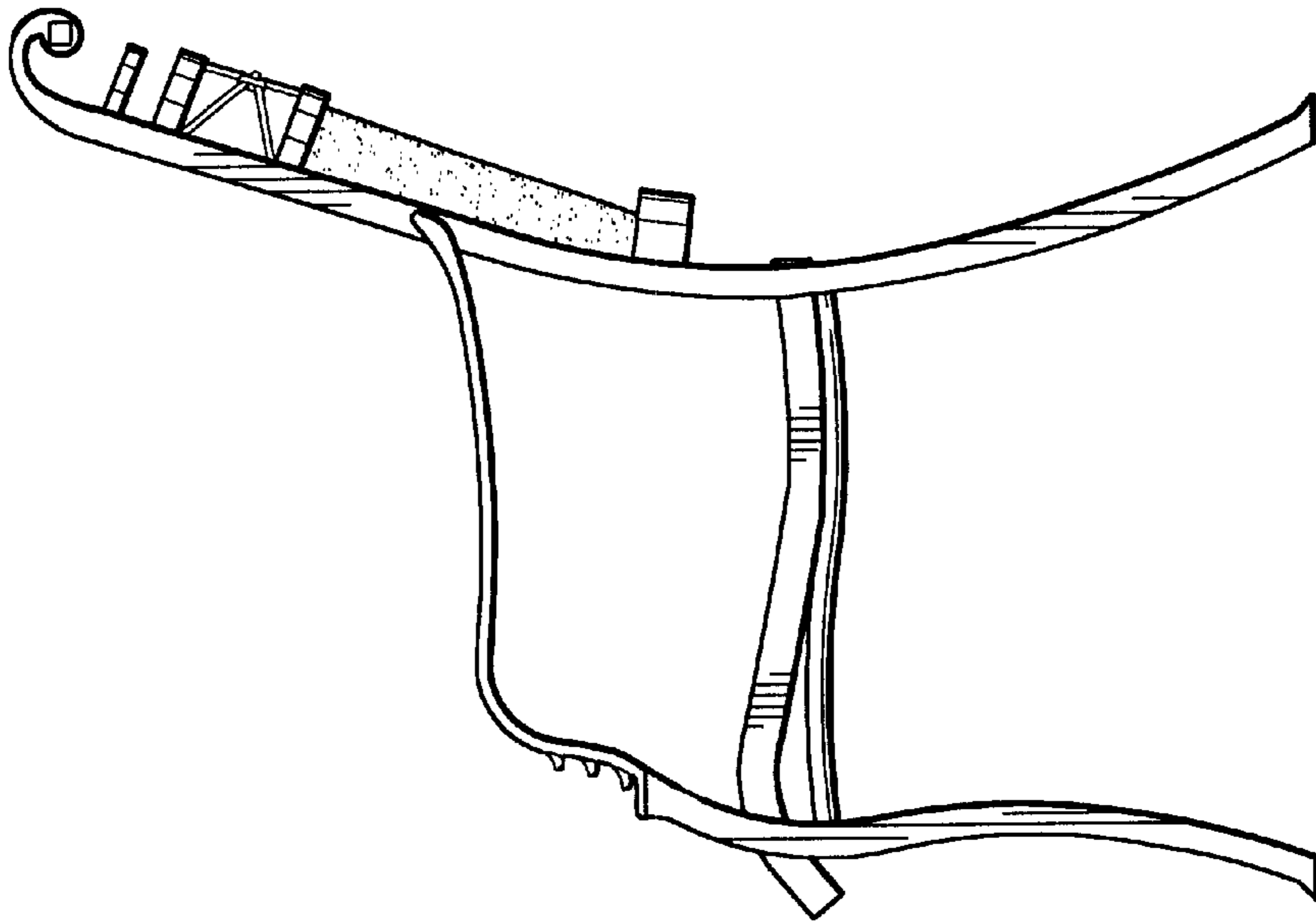

FIG. 5

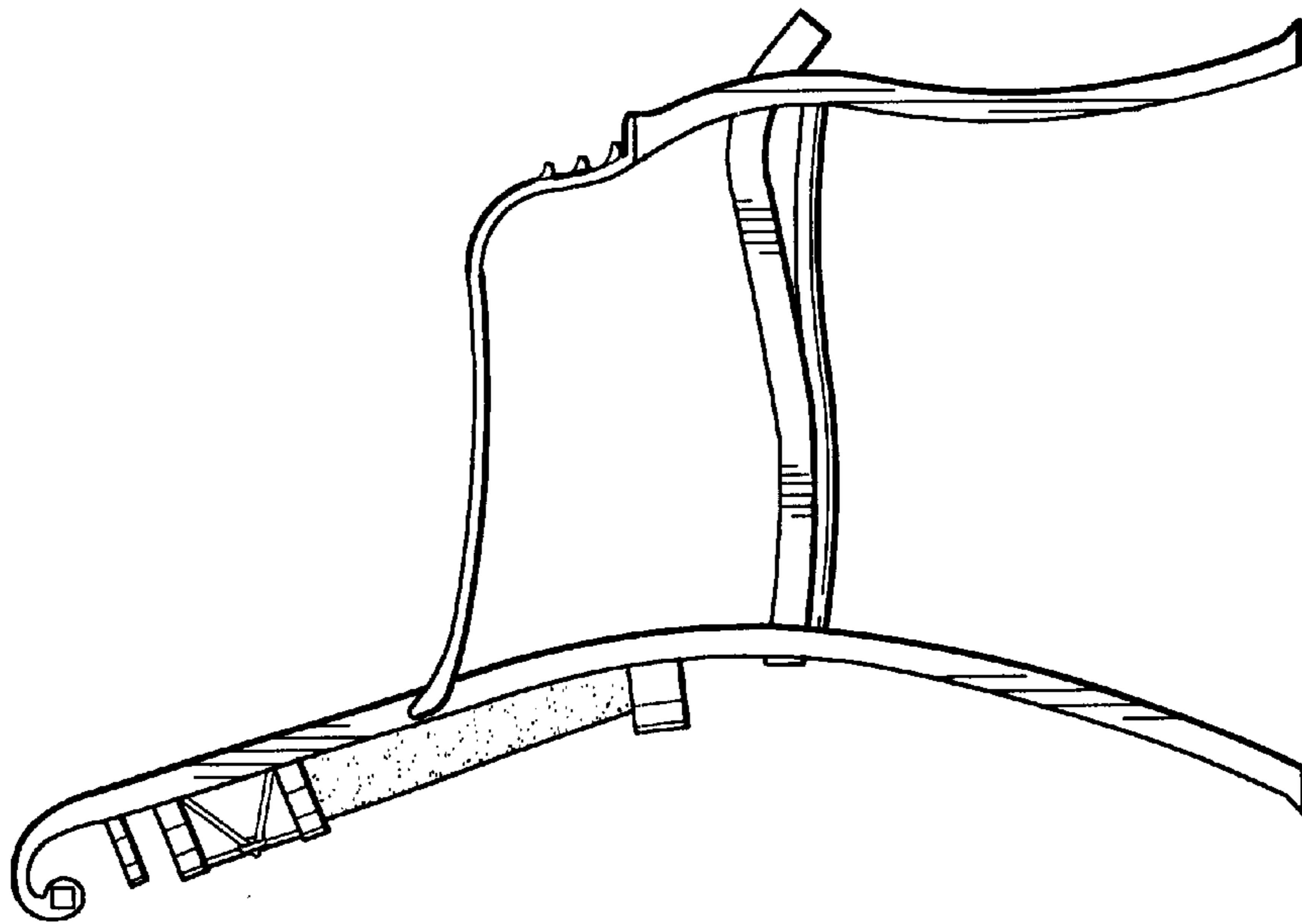

FIG. 4

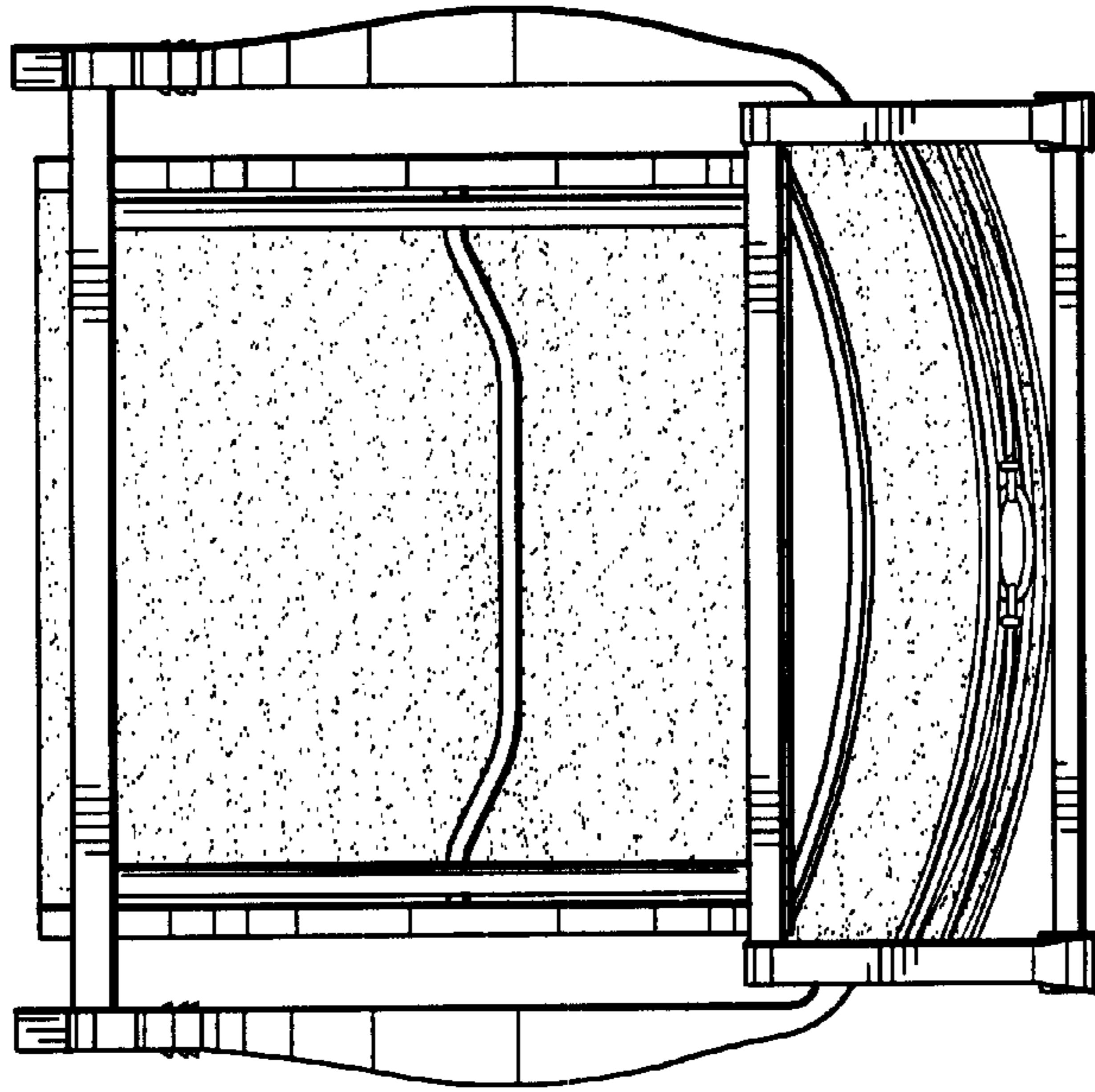

FIG. 7

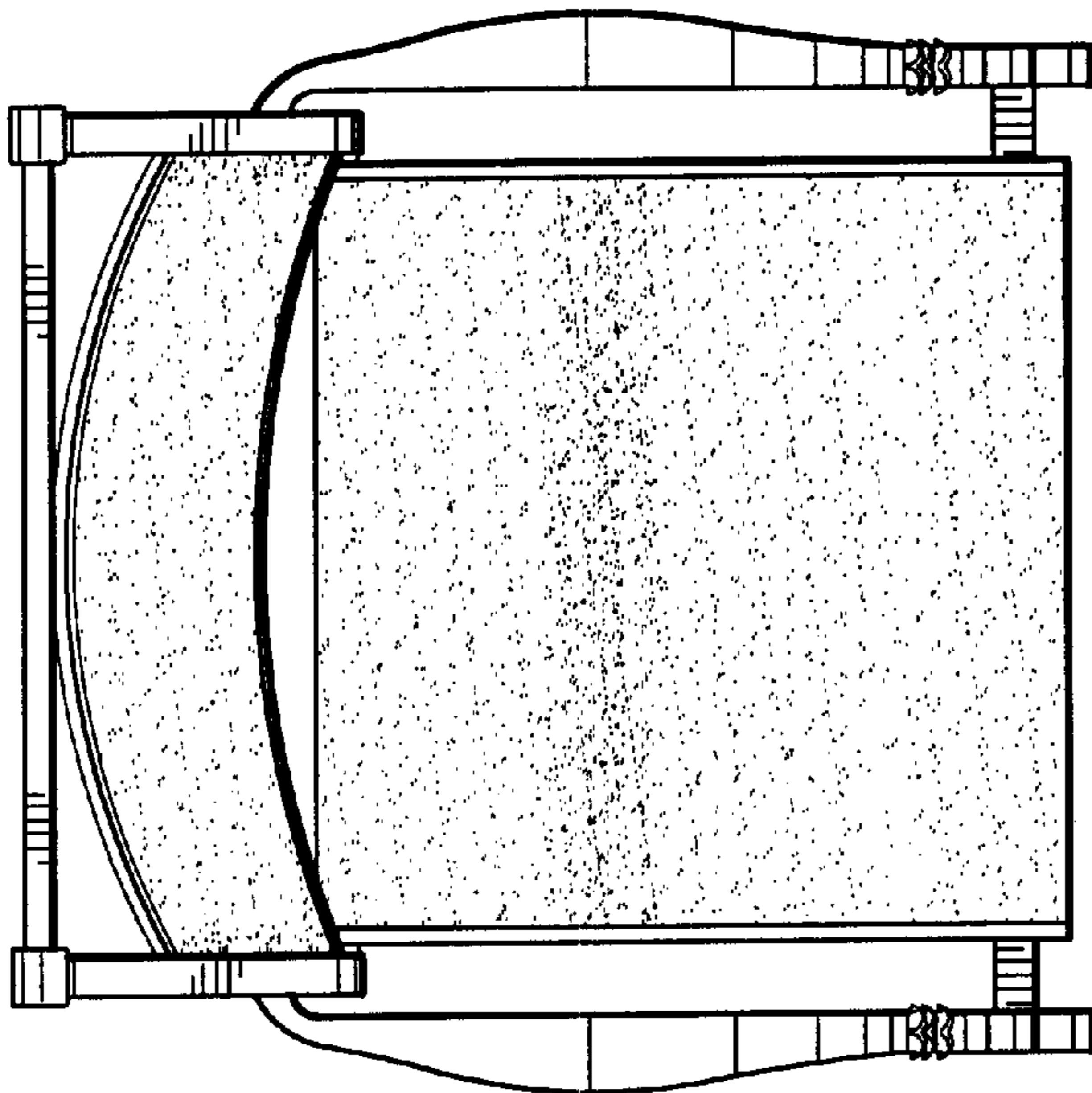

FIG. 6