



US00D486944S

(12) **United States Design Patent**  
**Bernard**

(10) **Patent No.:** **US D486,944 S**

(45) **Date of Patent:** **\*\* Feb. 17, 2004**

(54) **CONTAINER**

(75) Inventor: **Valérie Bernard**, Paris (FR)

(73) Assignee: **Techpack International** (FR)

(\*\*) Term: **14 Years**

(21) Appl. No.: **29/173,878**

(22) Filed: **Jan. 8, 2003**

(51) **LOC (7) Cl.** ..... **28-03**

(52) **U.S. Cl.** ..... **D28/78**

(58) **Field of Search** ..... D28/76-79, 81-83;  
132/293-307, 314-316; 206/581, 823

(56) **References Cited**

**U.S. PATENT DOCUMENTS**

D401,017 S	*	11/1998	Thorpe	.....	D28/78
D457,986 S	*	5/2002	Rodriguez et al.	.....	D28/78
D462,809 S	*	9/2002	LaSpina et al.	.....	D28/78

\* cited by examiner

*Primary Examiner*—Jennifer Rivard

(74) *Attorney, Agent, or Firm*—Cantor Colburn LLP

(57) **CLAIM**

The ornamental design for a container, as shown and described.

**DESCRIPTION**

FIG. 1 is a top and front perspective view of a container, showing my new design;

FIG. 2 is a front elevational view thereof;

FIG. 3 is a side elevational view thereof;

FIG. 4 is a side elevational view thereof;

FIG. 5 is a rear elevational view thereof;

FIG. 6 is a bottom plan view thereof; and,

FIG. 7 is a top plan view thereof.

**1 Claim, 3 Drawing Sheets**

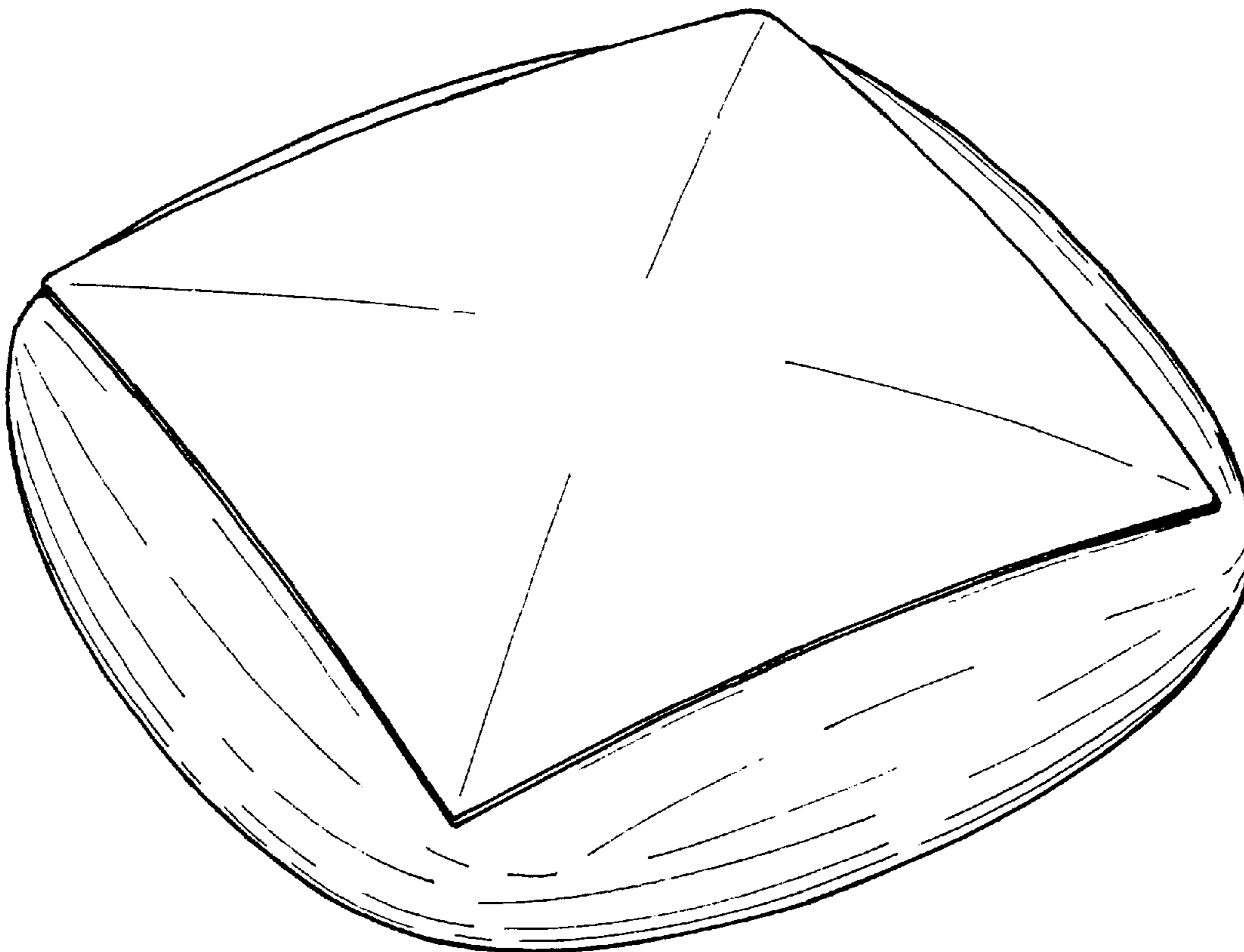

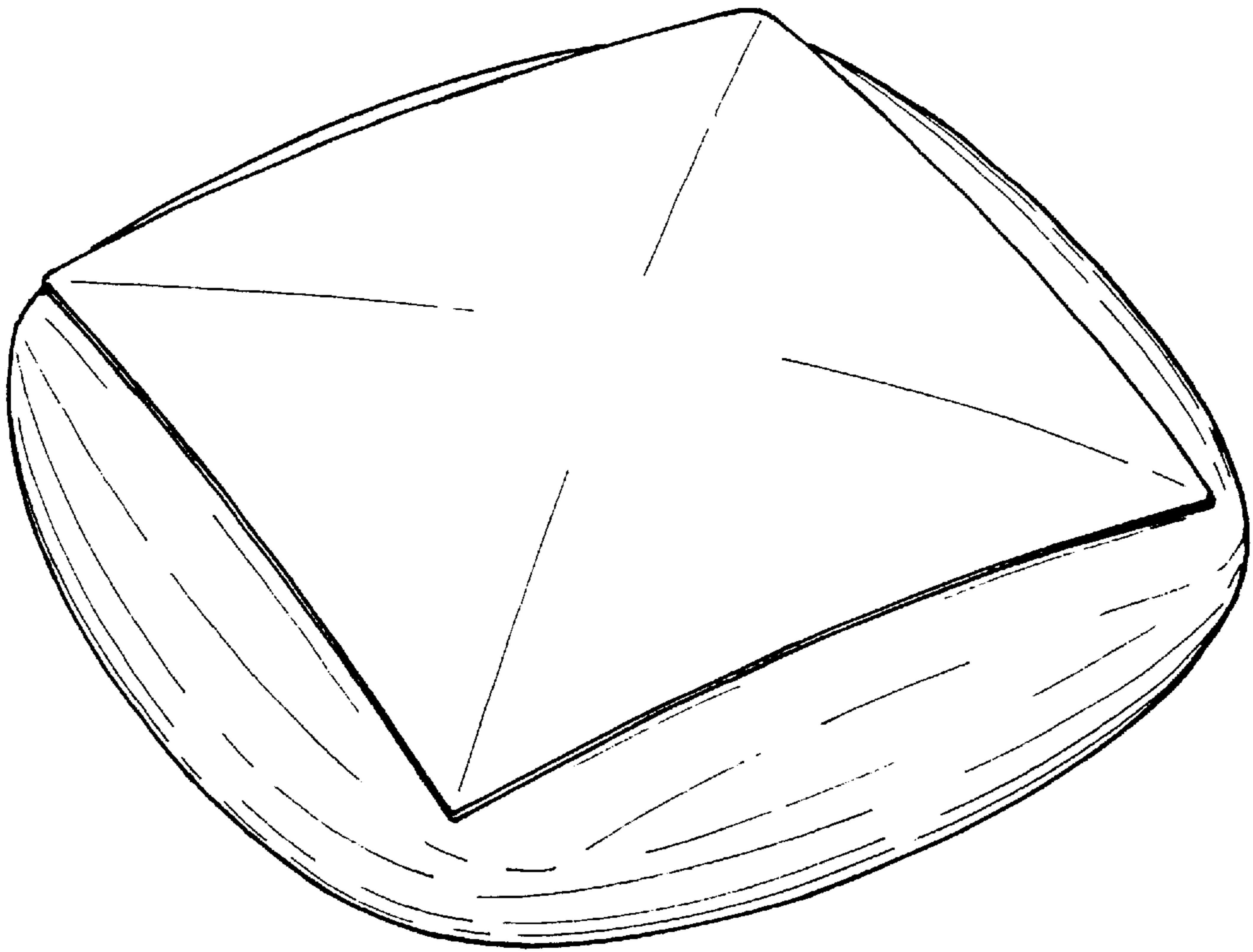

FIGURE 1

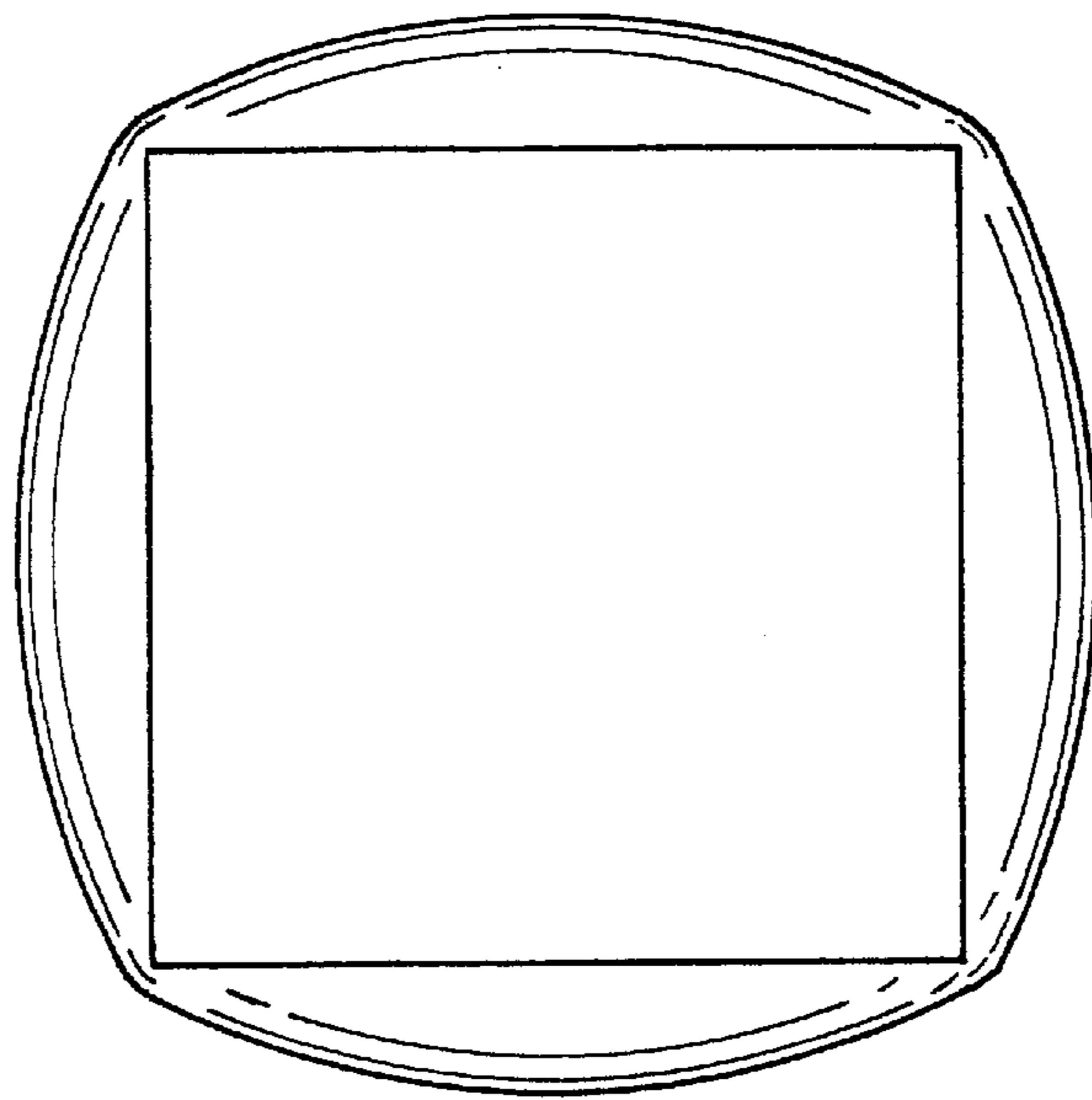

FIGURE 7

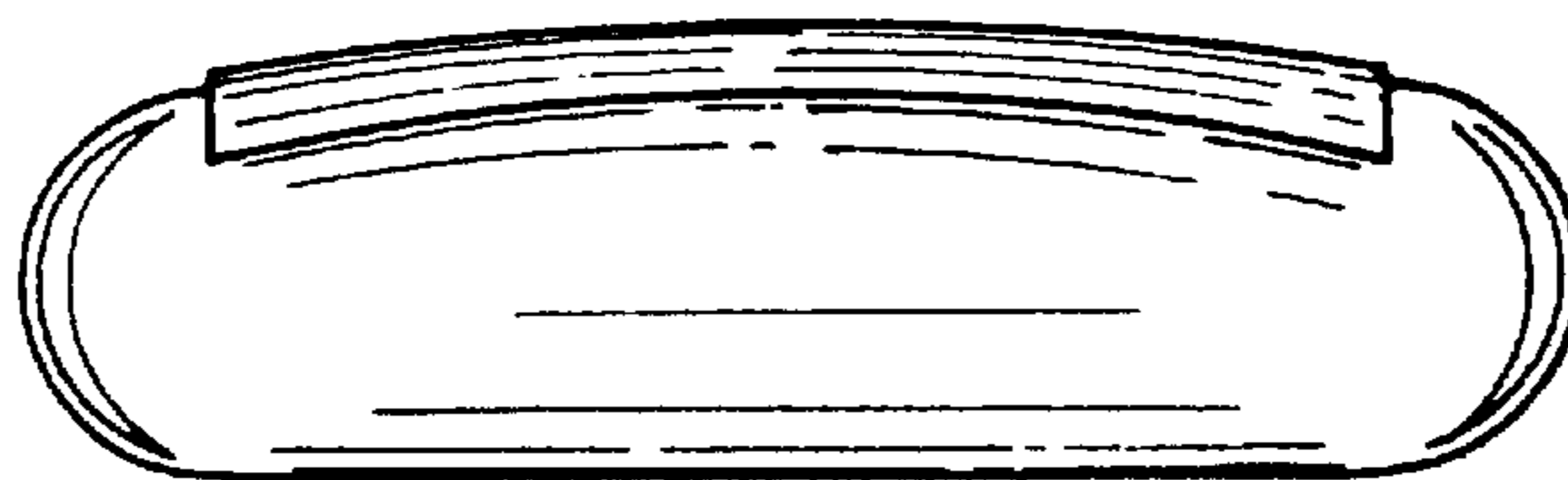

FIGURE 2

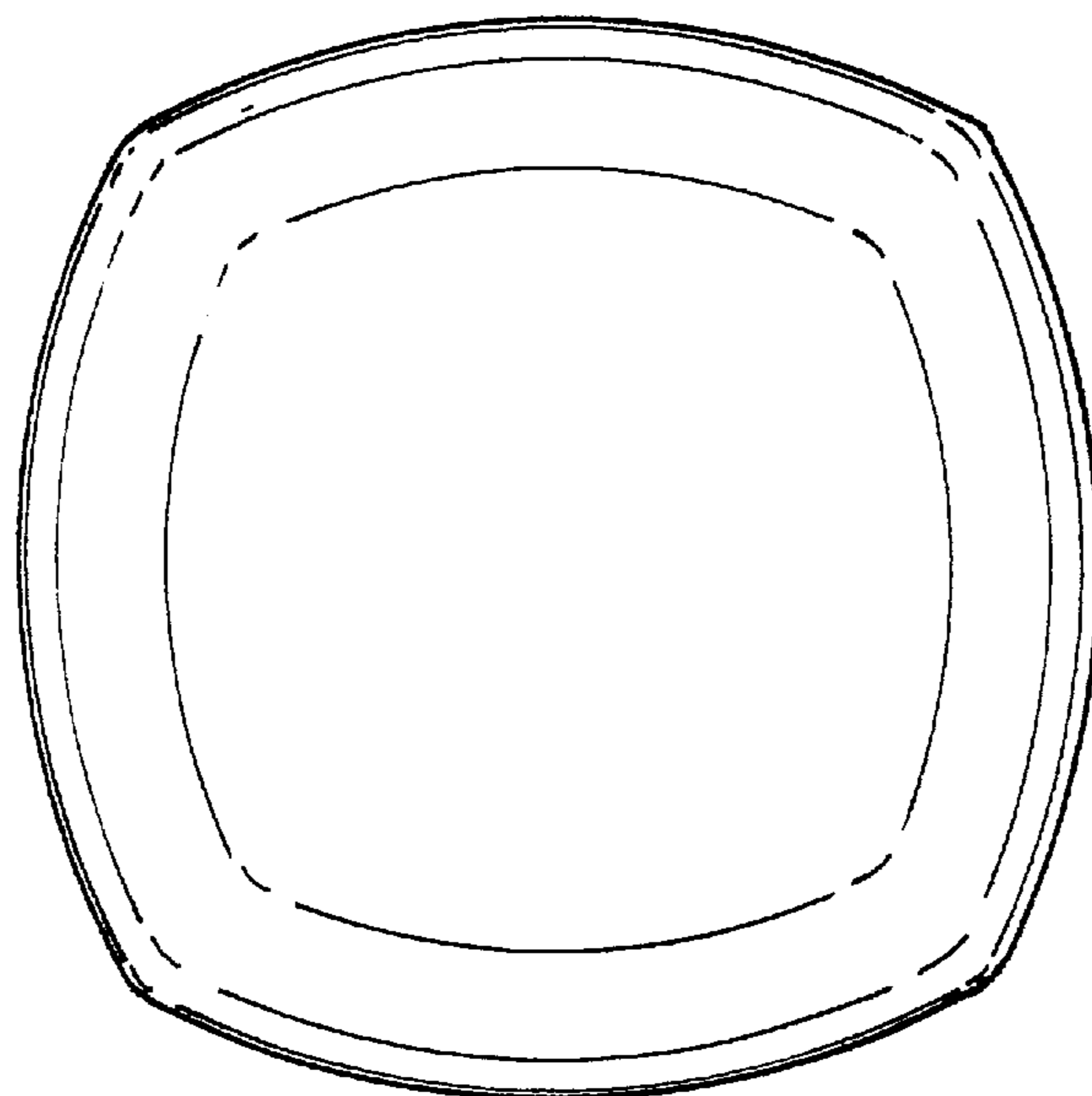

FIGURE 6

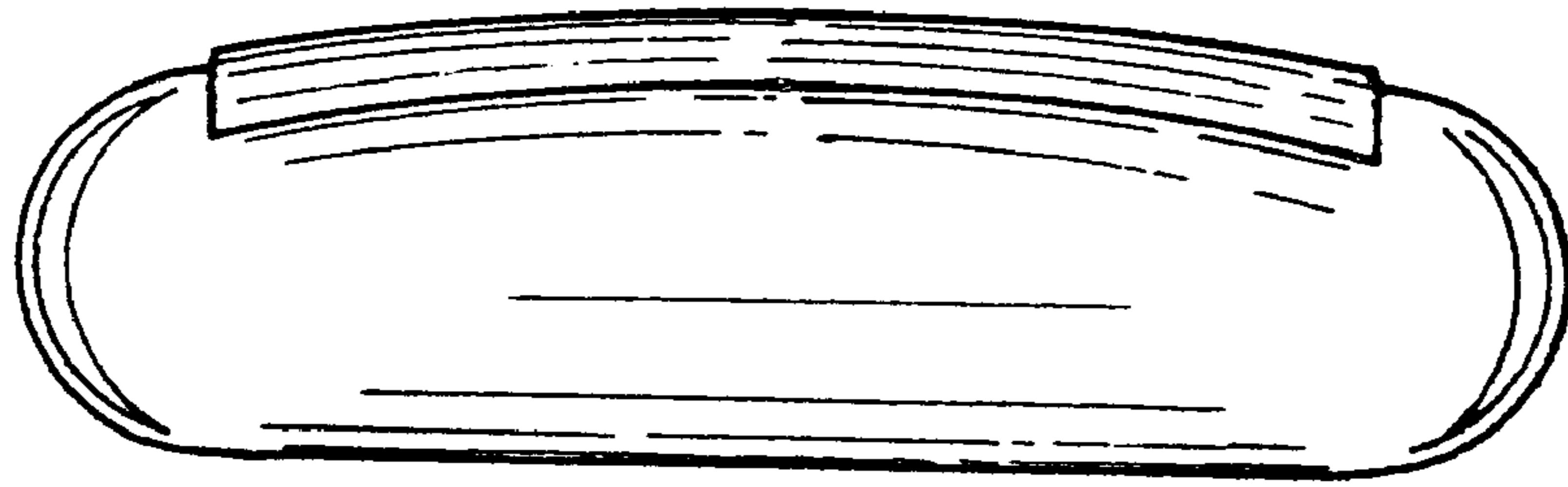

FIGURE 3

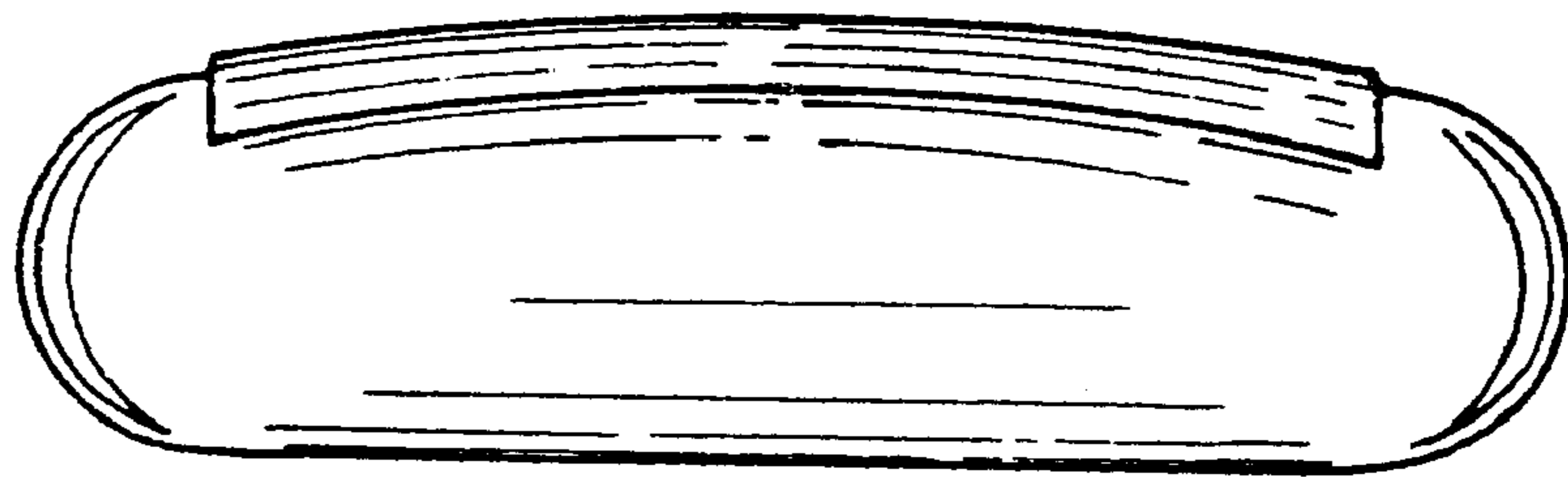

FIGURE 4

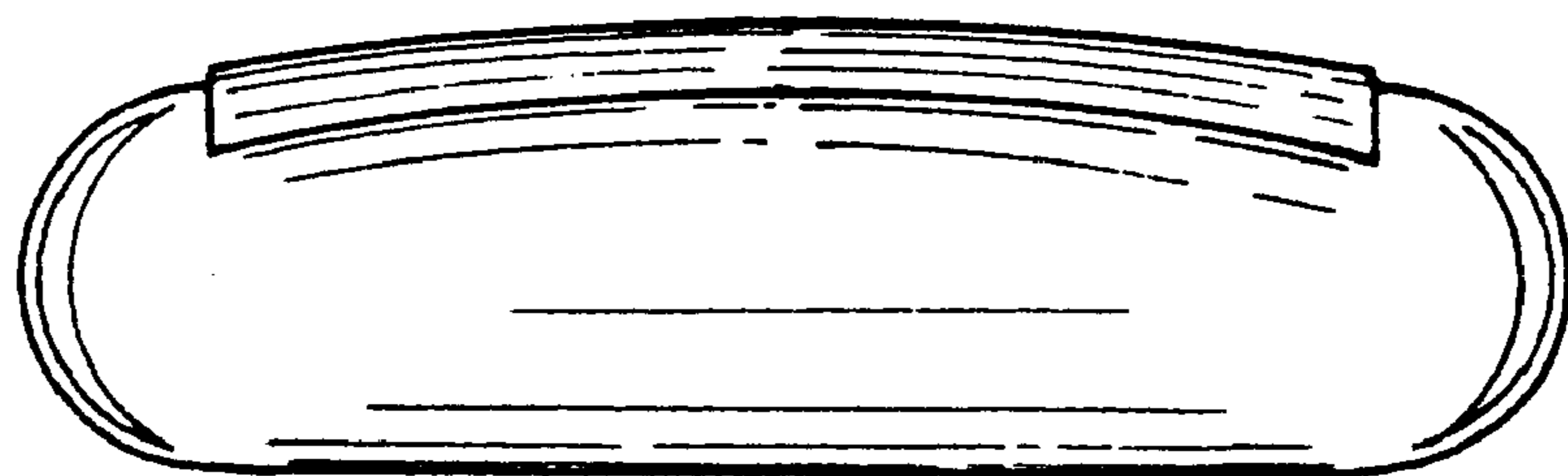

FIGURE 5

UNITED STATES PATENT AND TRADEMARK OFFICE  
**CERTIFICATE OF CORRECTION**

PATENT NO. : D486,944S  
DATED : February 17, 2004  
INVENTOR(S) : Valerie Bernard

Page 1 of 1

It is certified that error appears in the above-identified patent and that said Letters Patent is hereby corrected as shown below:

Title Page,

Item [30], **Foreign Application Priority Data**, insert:

-- [30] **Foreign Application Priority Data** July 10, 2002 (FR) ..... 02 4213 --

Signed and Sealed this

Eighth Day of June, 2004

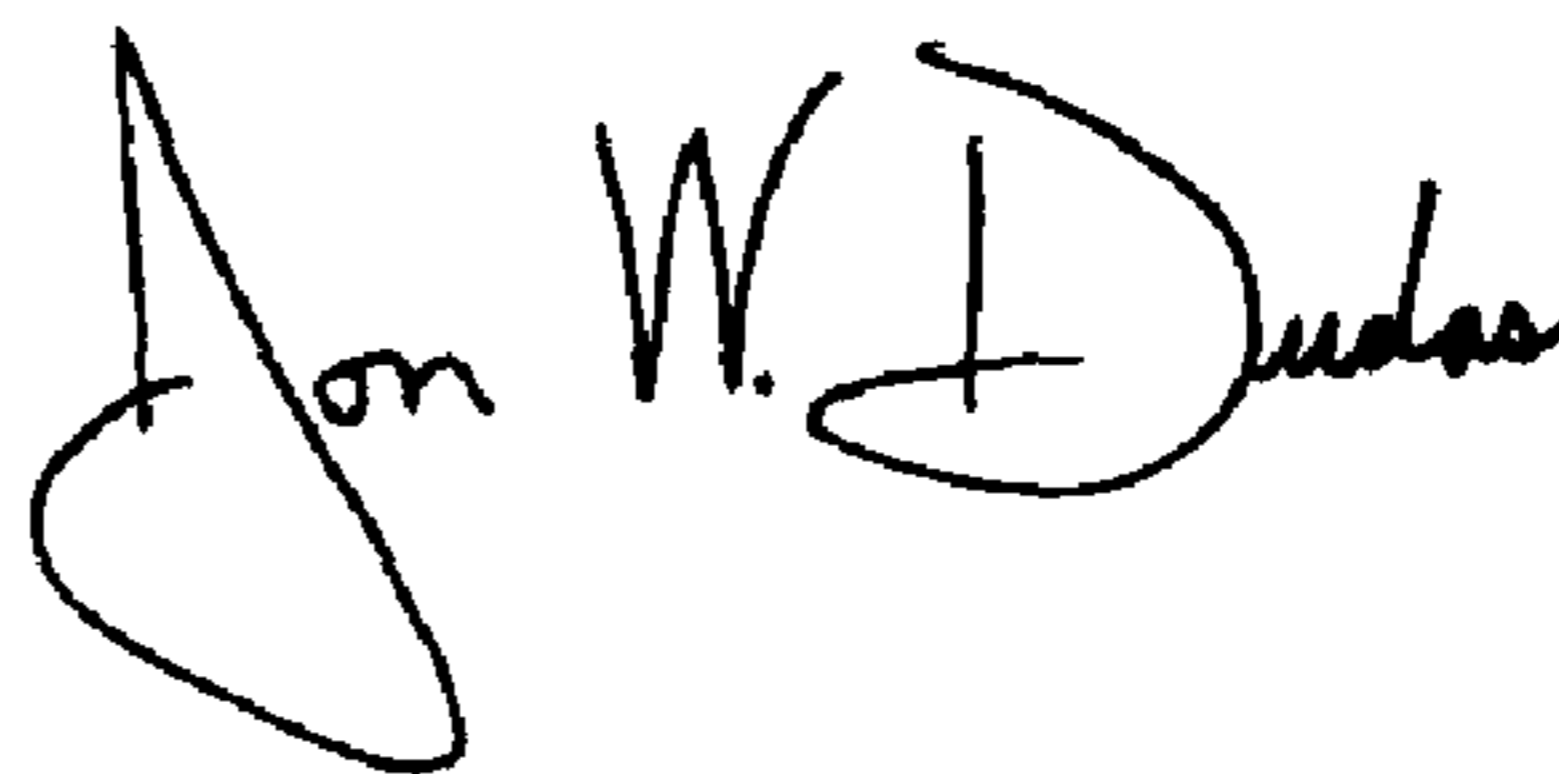
A handwritten signature in black ink that reads "Jon W. Dudas". The signature is written in a cursive style with a large, looped initial "J".

---

JON W. DUDAS  
*Acting Director of the United States Patent and Trademark Office*