



US00D486937S

(12) **United States Design Patent**
Shiu

(10) **Patent No.:** **US D486,937 S**

(45) **Date of Patent:** **** Feb. 17, 2004**

(54) **FLASHLIGHT**

(75) **Inventor:** **Stephanie Wai Man Shiu, Kowloon (HK)**

(73) **Assignee:** **Gold Coral International Limited, Kowloon (HK)**

(**) **Term:** **14 Years**

(21) **Appl. No.:** **29/181,340**

(22) **Filed:** **May 8, 2003**

(30) **Foreign Application Priority Data**

Nov. 8, 2002 (HK) 0211834

(51) **LOC (7) Cl.** **26-02**

(52) **U.S. Cl.** **D26/49**

(58) **Field of Search** D26/37-50; 362/157, 362/158, 171, 172, 173, 183-208

(56) **References Cited**

U.S. PATENT DOCUMENTS

D457,976 S * 5/2002 Kung D26/49

D467,022 S * 12/2002 Fritz D26/49

D479,014 S * 8/2003 Yamamoto et al. D26/49

* cited by examiner

Primary Examiner—Marcus A. Jackson

(74) *Attorney, Agent, or Firm*—Mitchell Silberberg & Knupp LLP

(57) **CLAIM**

The ornamental design for a flashlight, as shown and described.

DESCRIPTION

FIG. 1 is a top plan view of a flashlight according to a first embodiment of the invention, the bottom plan view being essentially identical.

FIG. 2 is a front elevational view of a flashlight according to all three illustrated embodiments of the invention.

FIG. 3 is a rear elevational view of a flashlight according to all three illustrated embodiments of the invention.

FIG. 4 is a right side elevational view of a flashlight according to the first embodiment of the invention, the left side elevational view being essentially identical.

FIG. 5 is a top plan view of a flashlight according to a second embodiment of the invention, the bottom plan view being essentially identical.

FIG. 6 is a right side elevational view of the flashlight according to the second embodiment of the invention, the left side elevational view being essentially identical.

FIG. 7 is a top plan view of a flashlight according to a third embodiment of the invention, the bottom plan view being essentially identical; and,

FIG. 8 is a right side elevational view of the flashlight according to the third embodiment of the invention, the left side elevational view being essentially identical.

1 Claim, 3 Drawing Sheets

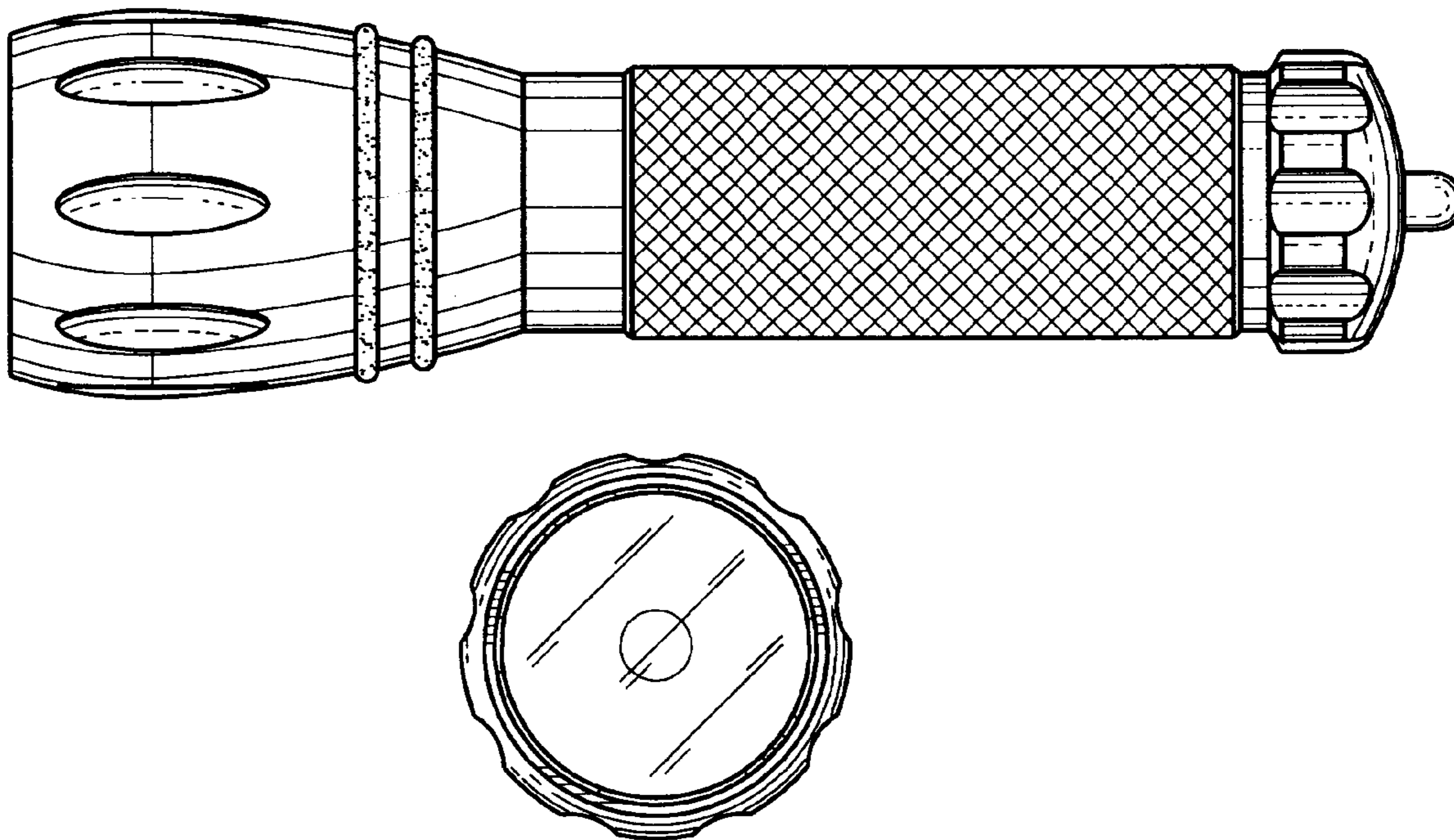

FIG. 1

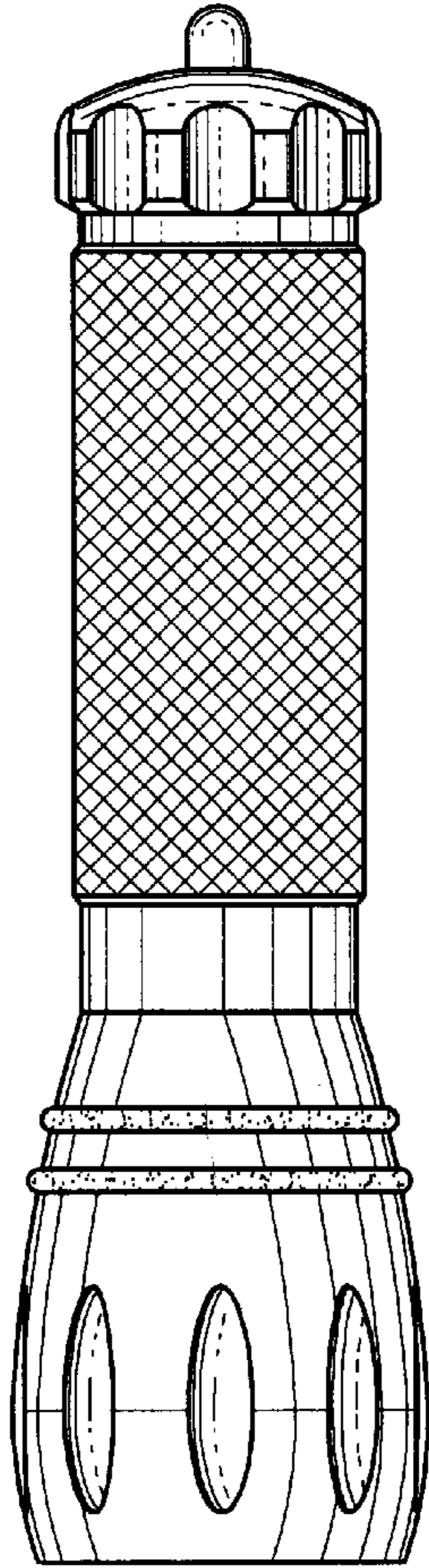

FIG. 4

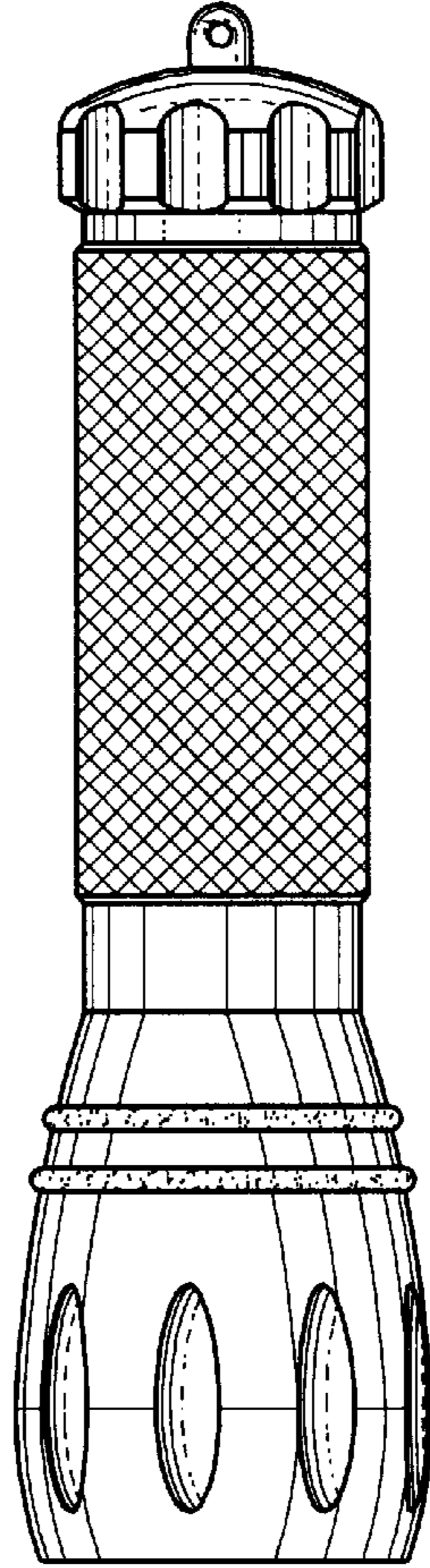

FIG. 3

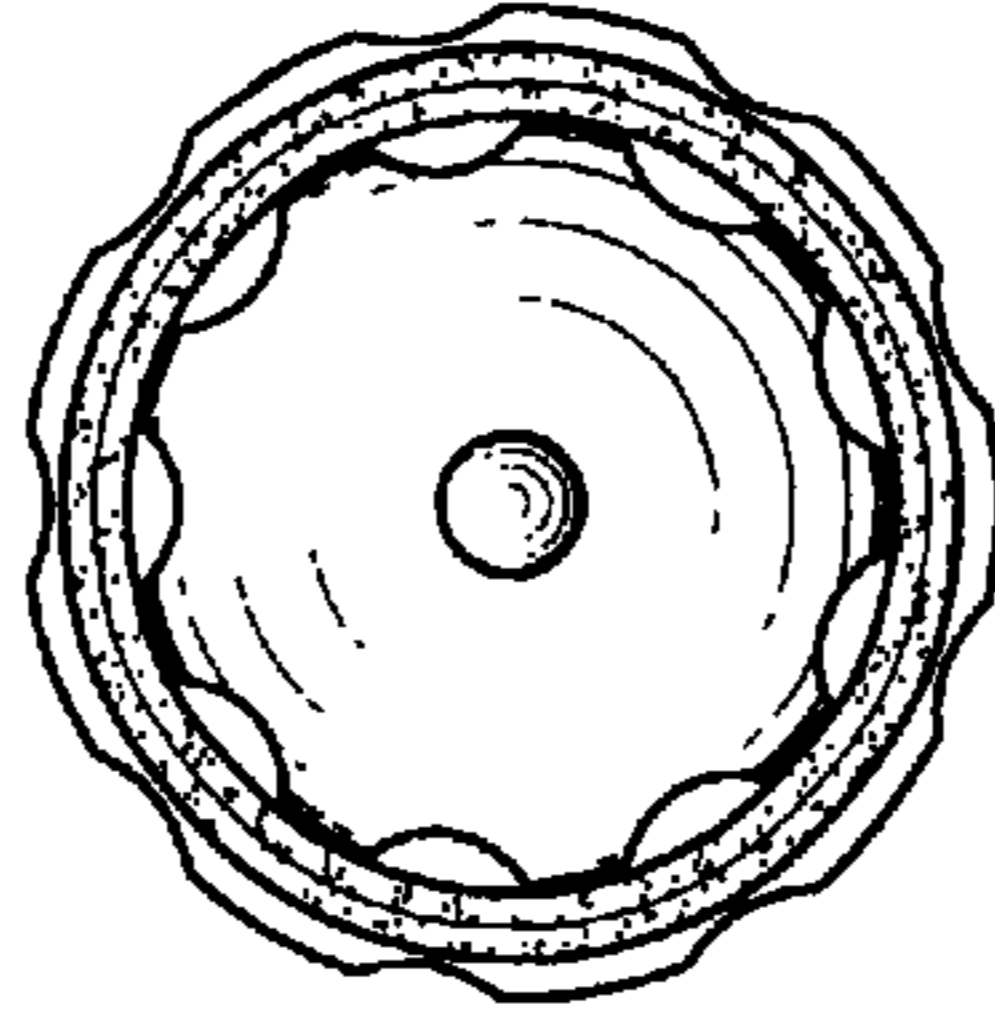

FIG. 2

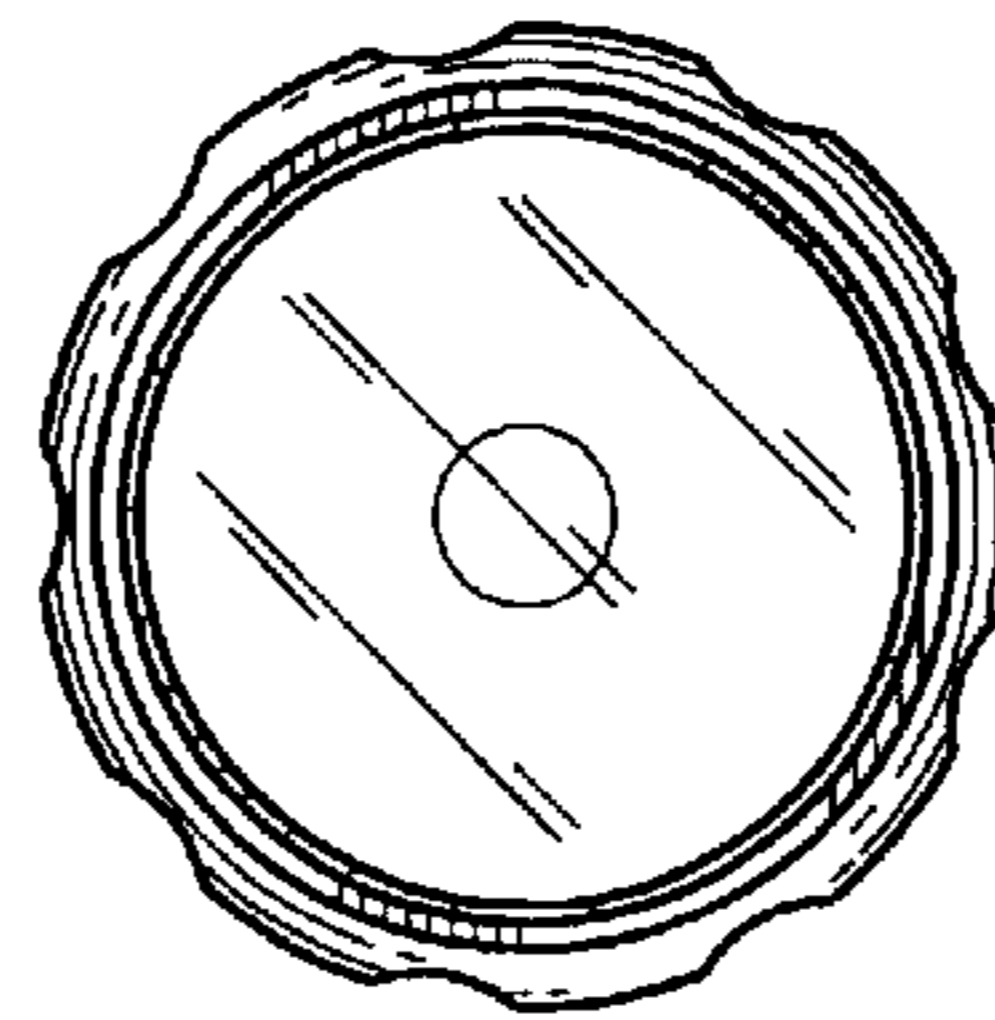

FIG. 5

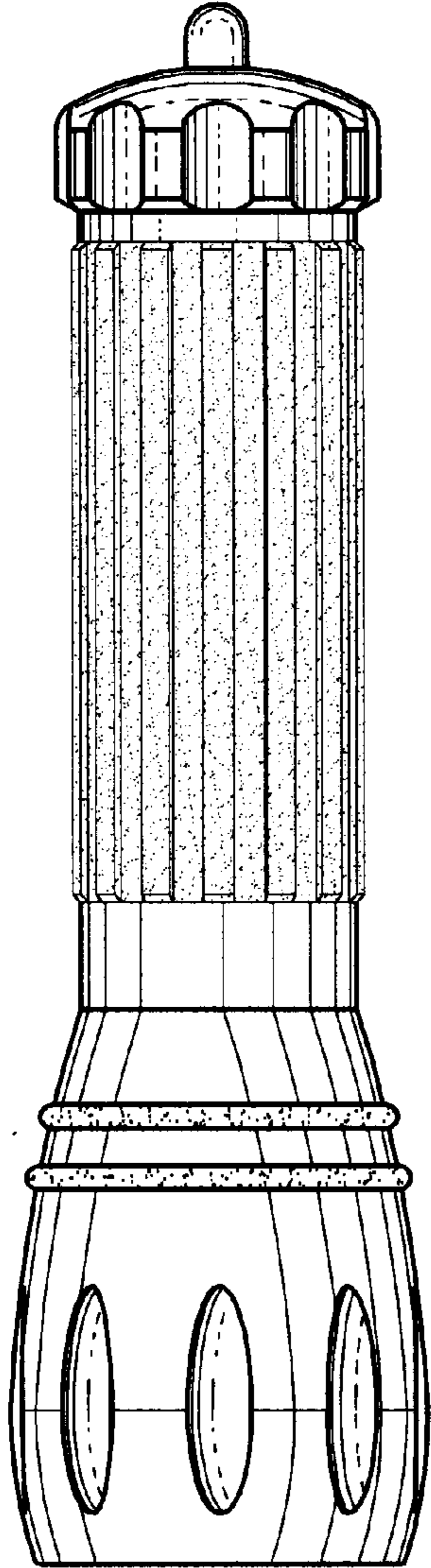
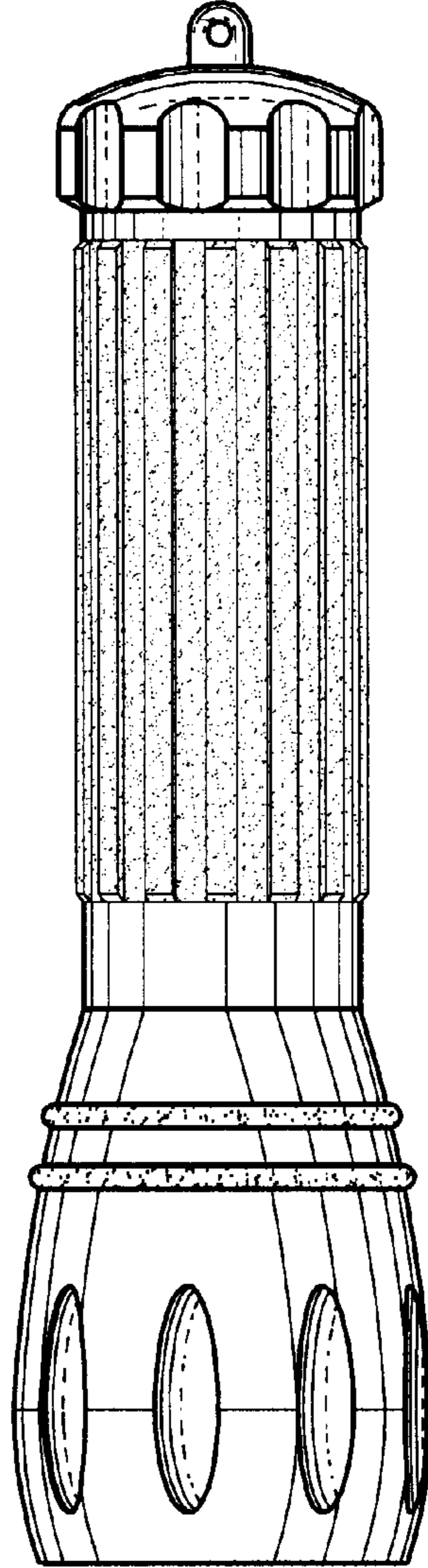

FIG. 6



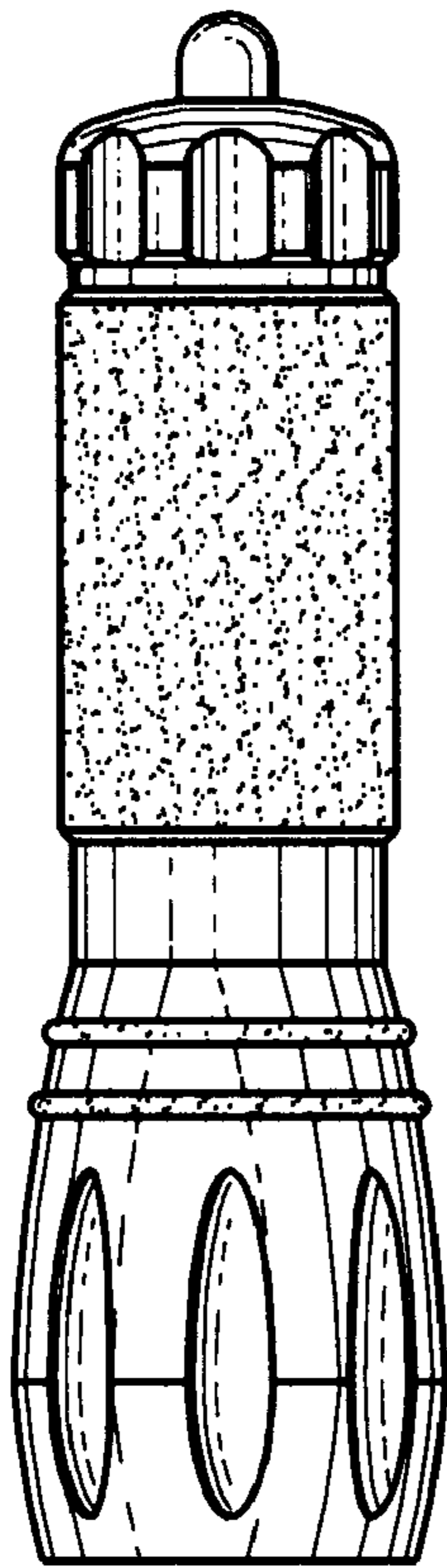

FIG. 7

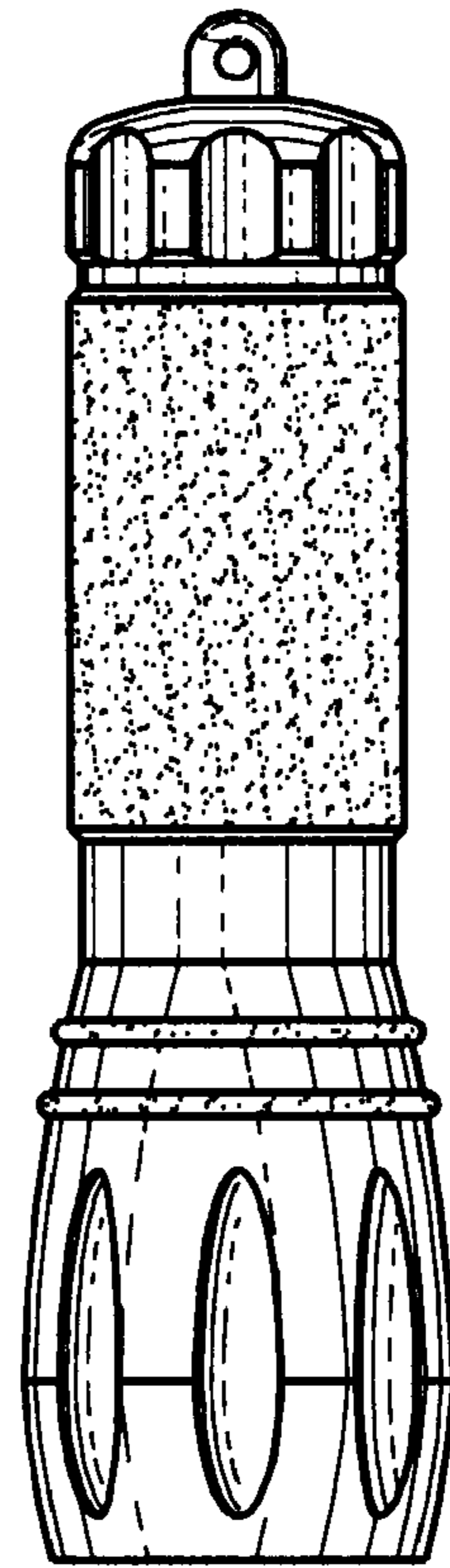

FIG. 8