



US00D486902S

(12) **United States Design Patent**
Melwani

(10) **Patent No.:** **US D486,902 S**

(45) **Date of Patent:** **** Feb. 17, 2004**

(54) **ELECTRIC FAN**

D461,552 S * 8/2002 Wright D23/379

(75) Inventor: **Ravin G. Melwani**, HK SAR (CN)

* cited by examiner

(73) Assignee: **B.K. Rekhatex Ltd.**, Kowloon (HK)

Primary Examiner—Lisa Lichtenstein

(**) Term: **14 Years**

(74) *Attorney, Agent, or Firm*—Alix, Yale & Ristas, LLP

(21) Appl. No.: **29/183,529**

(57) **CLAIM**

The ornamental design for an electric fan, as shown and described.

(22) Filed: **Jun. 11, 2003**

DESCRIPTION

(51) **LOC (7) Cl.** **23-04**

(52) **U.S. Cl.** **D23/370**

(58) **Field of Search** D23/370, 379,
D23/411, 413; 416/244 R, 247 R, 246 R,
63

FIG. 1 is a front, right side and top perspective view of an electric fan showing my new design (with its upper body tilted slightly upwardly in this figure only); FIG. 2 is a front elevational view thereof; FIG. 3 is a top plan view thereof; FIG. 4 is a right side elevational view thereof; FIG. 5 is a left side elevational view thereof; FIG. 6 is a rear elevational view thereof; and, FIG. 7 is a bottom plan view thereof.

(56) **References Cited**

U.S. PATENT DOCUMENTS

D438,301 S * 2/2001 Hsu D23/411
6,409,475 B1 * 6/2002 Ho 416/63

1 Claim, 5 Drawing Sheets

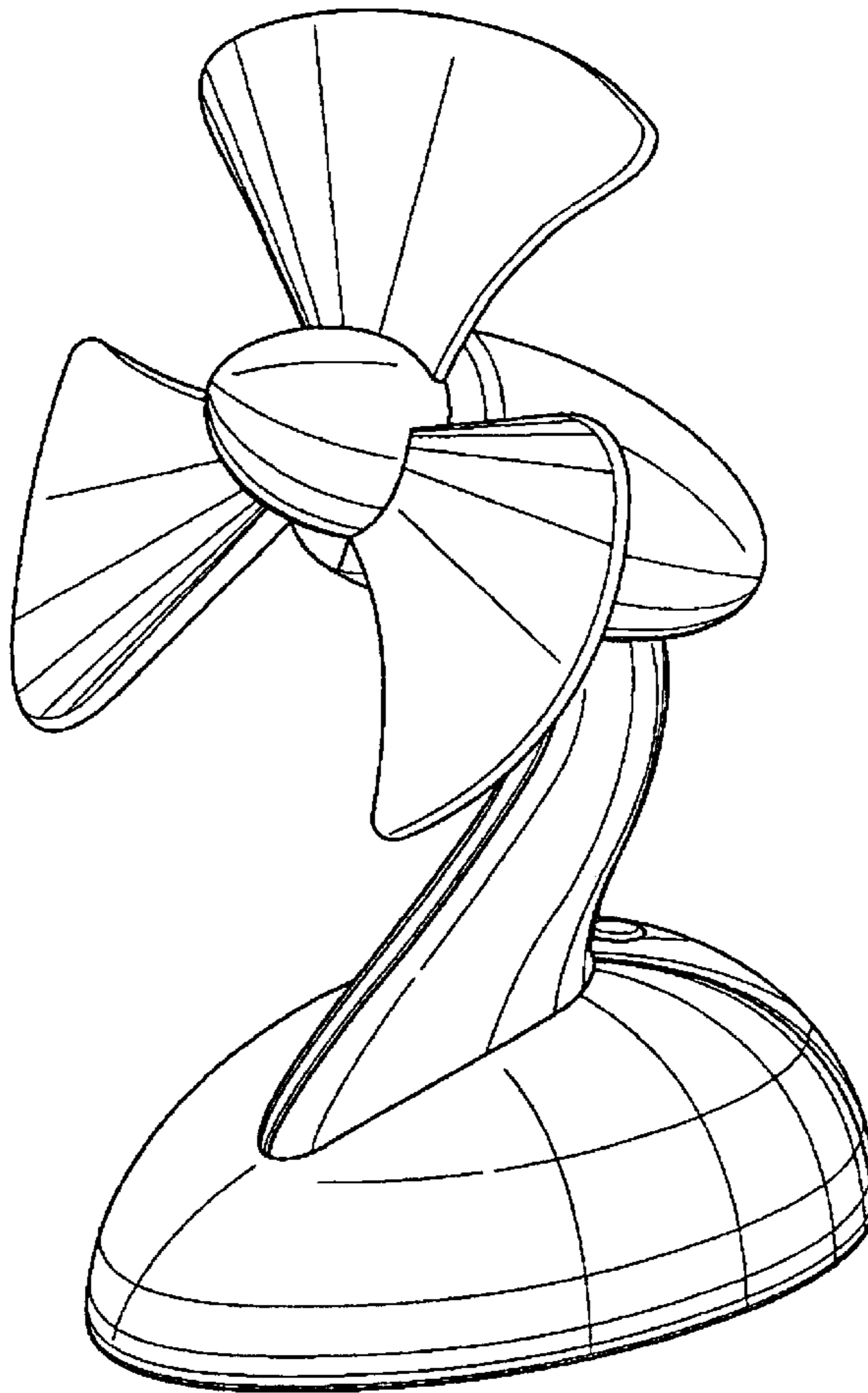

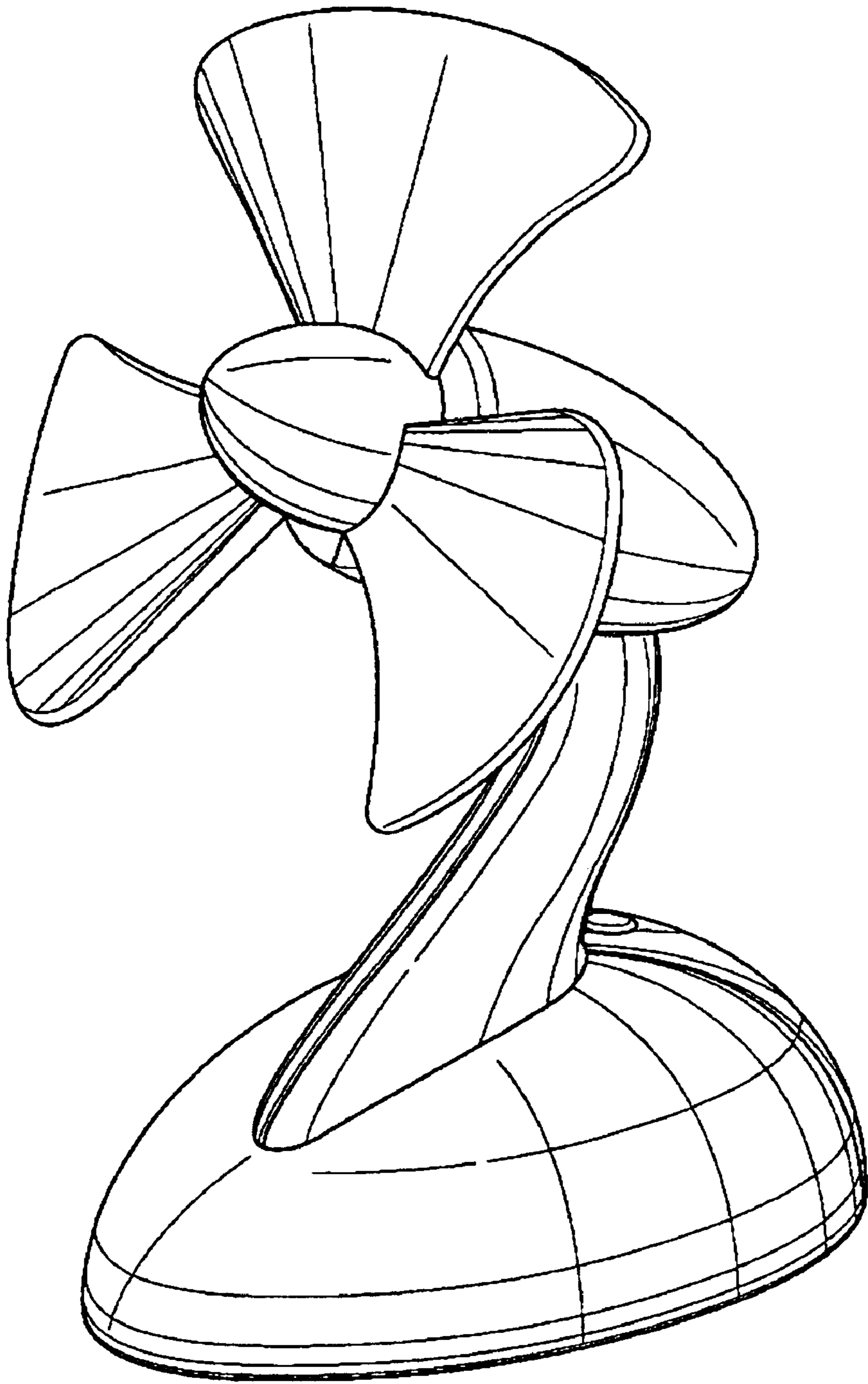

FIG. 1

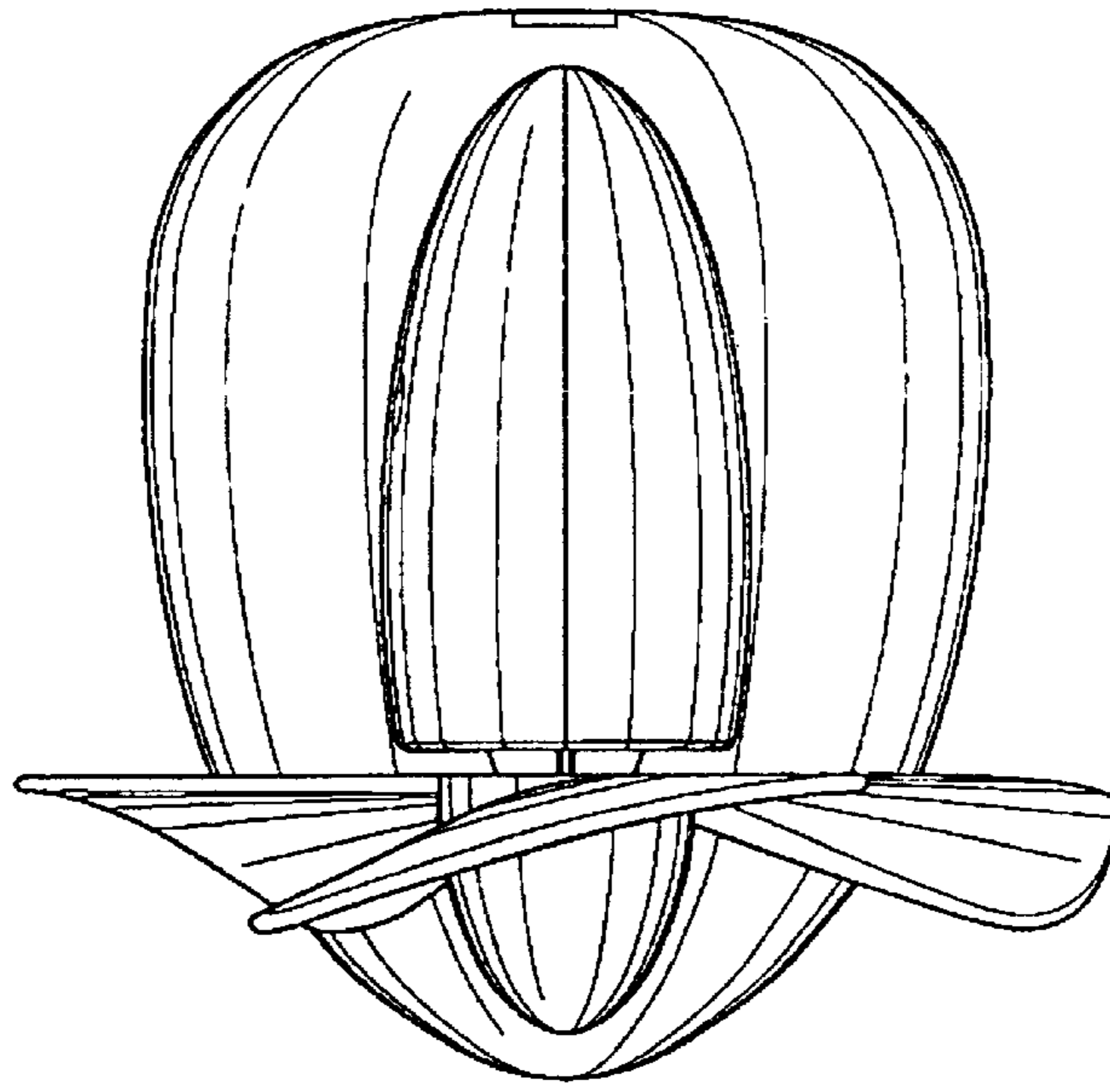

FIG. 3

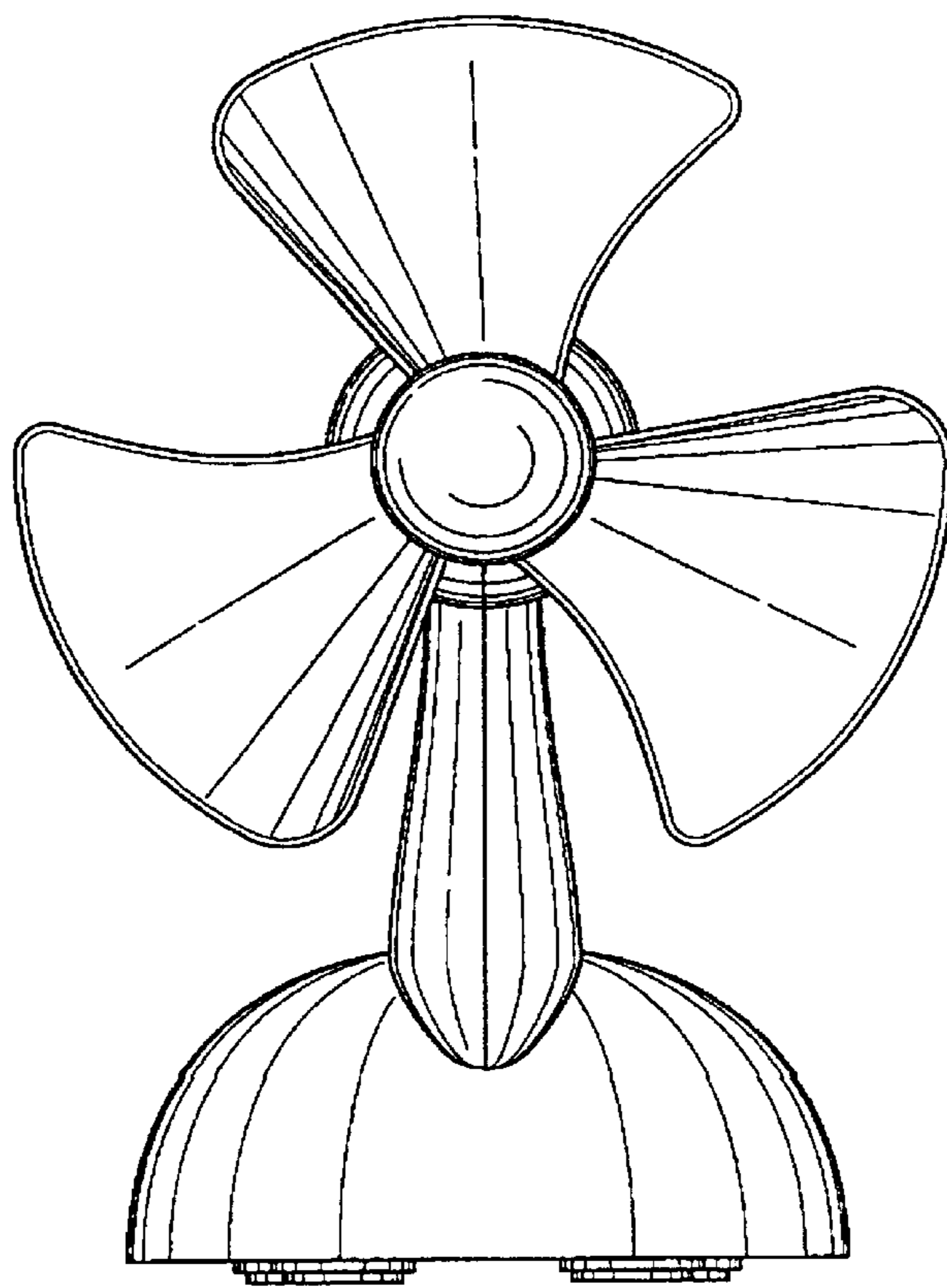

FIG. 2

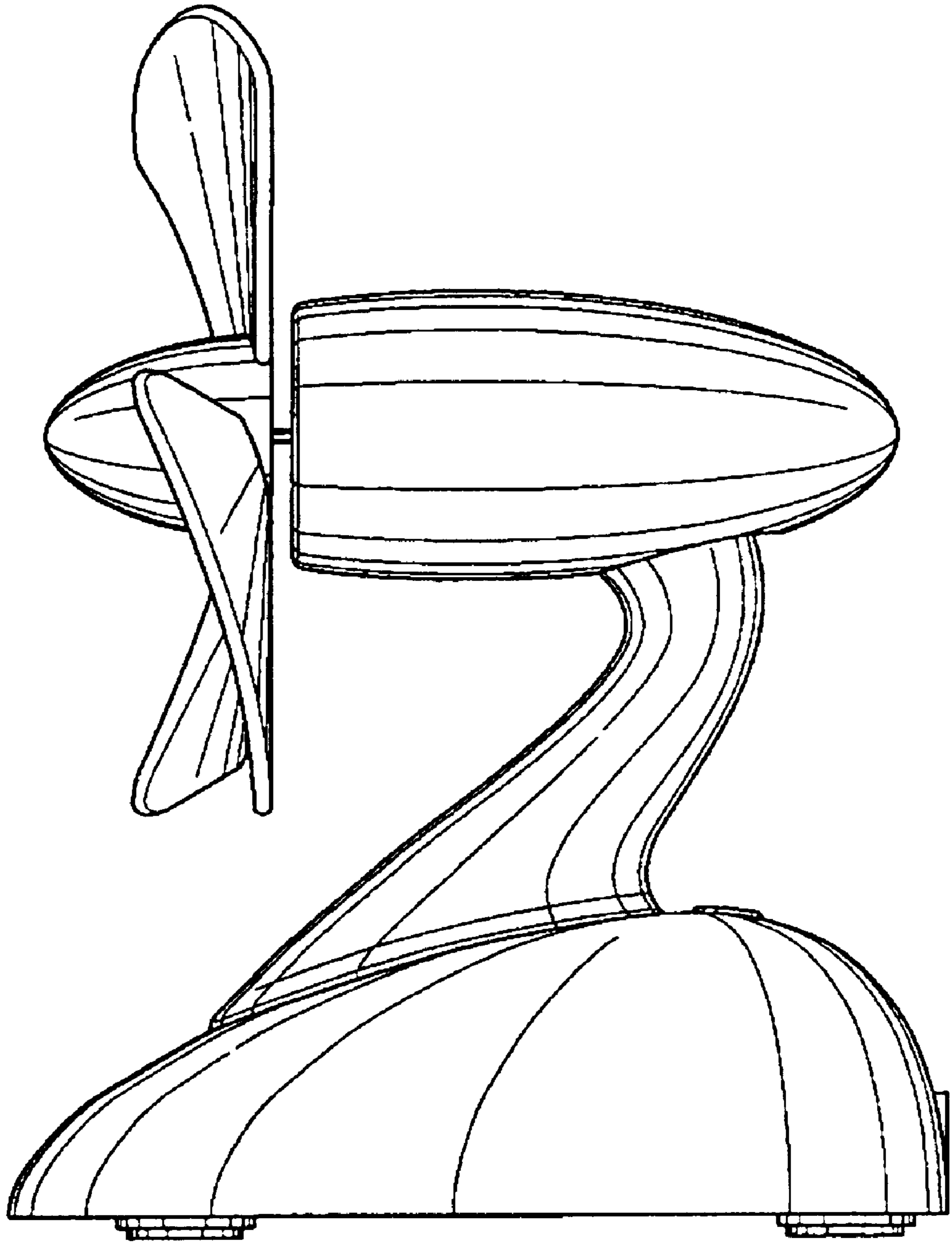

FIG. 4

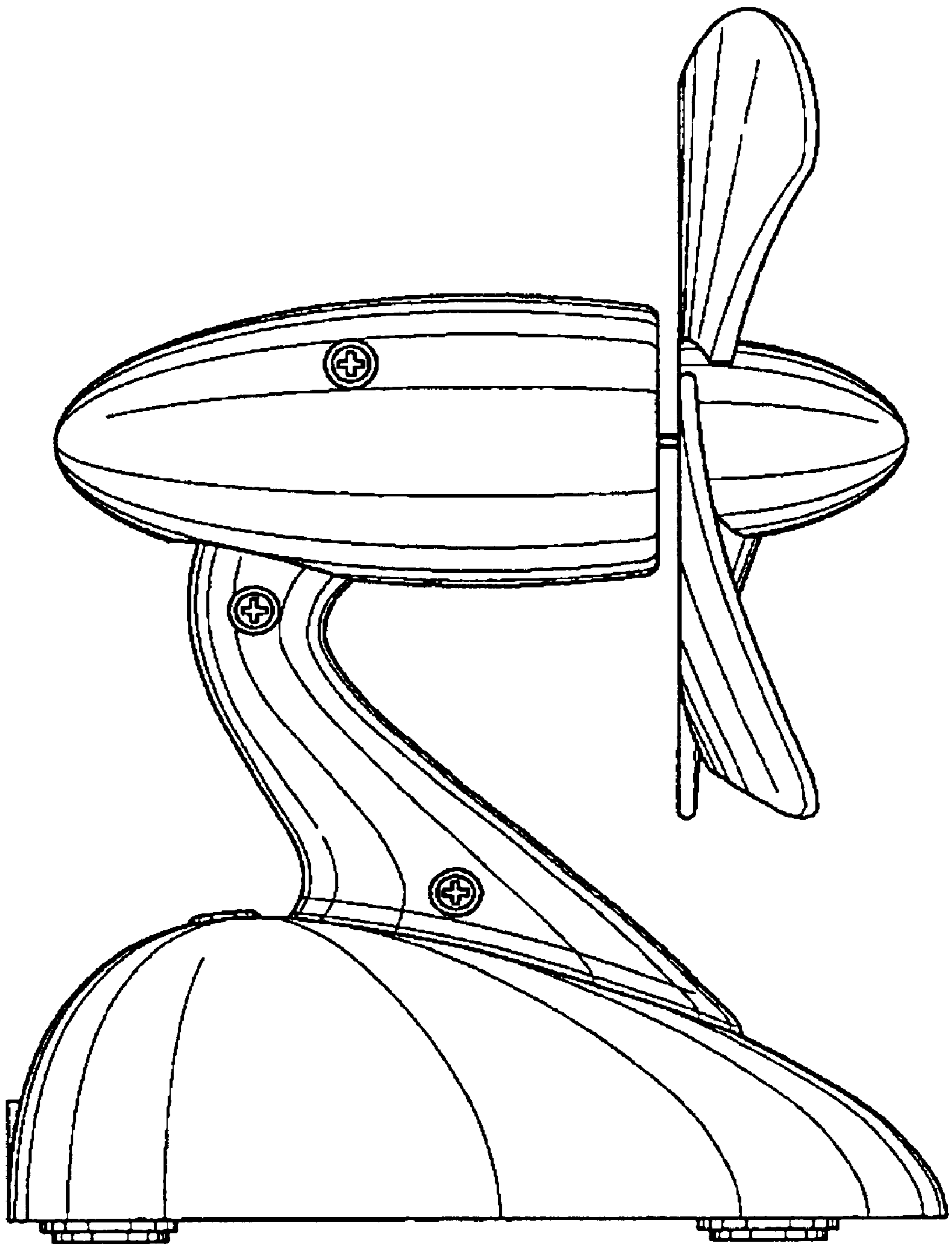

FIG. 5

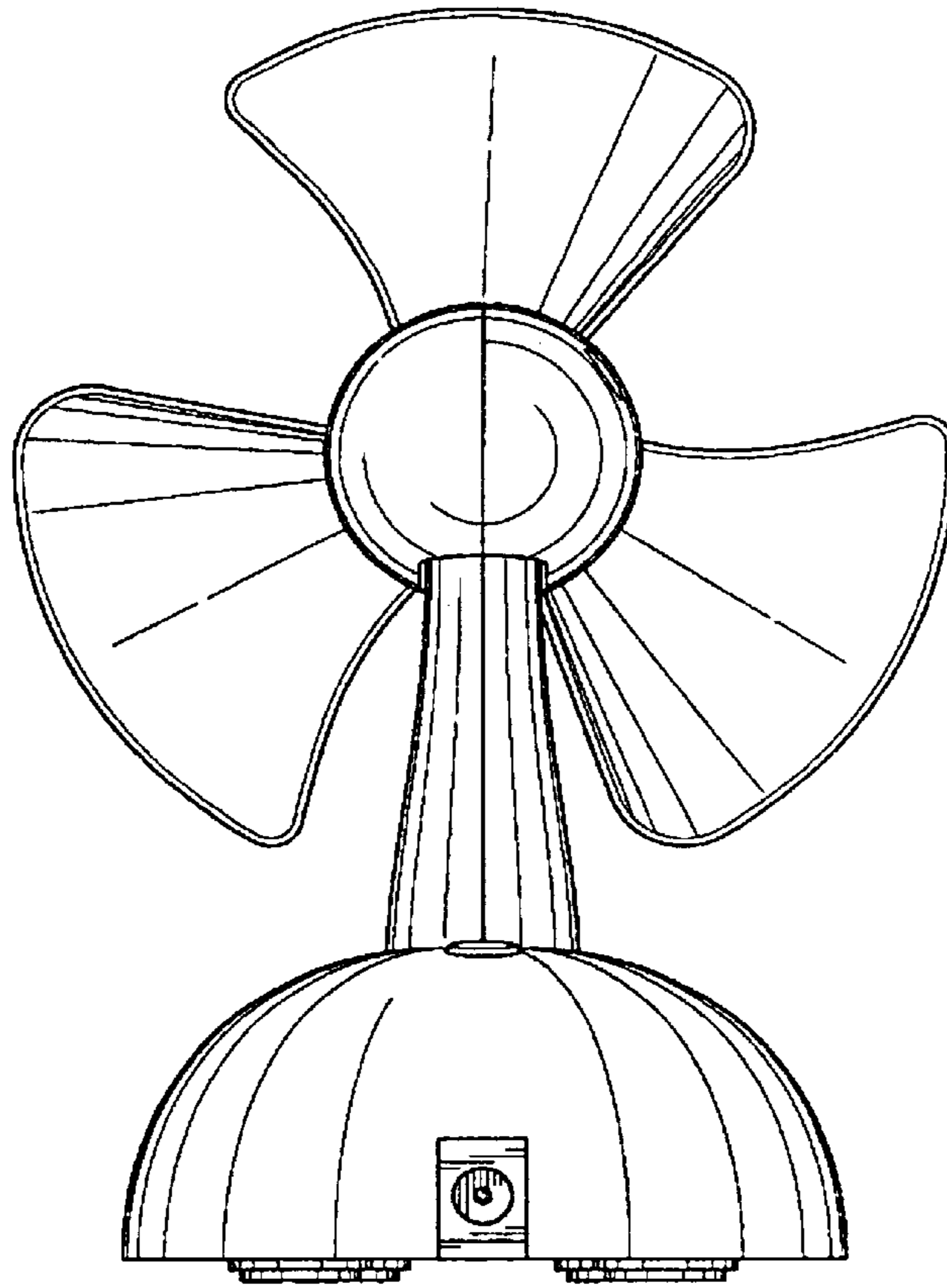

FIG. 6

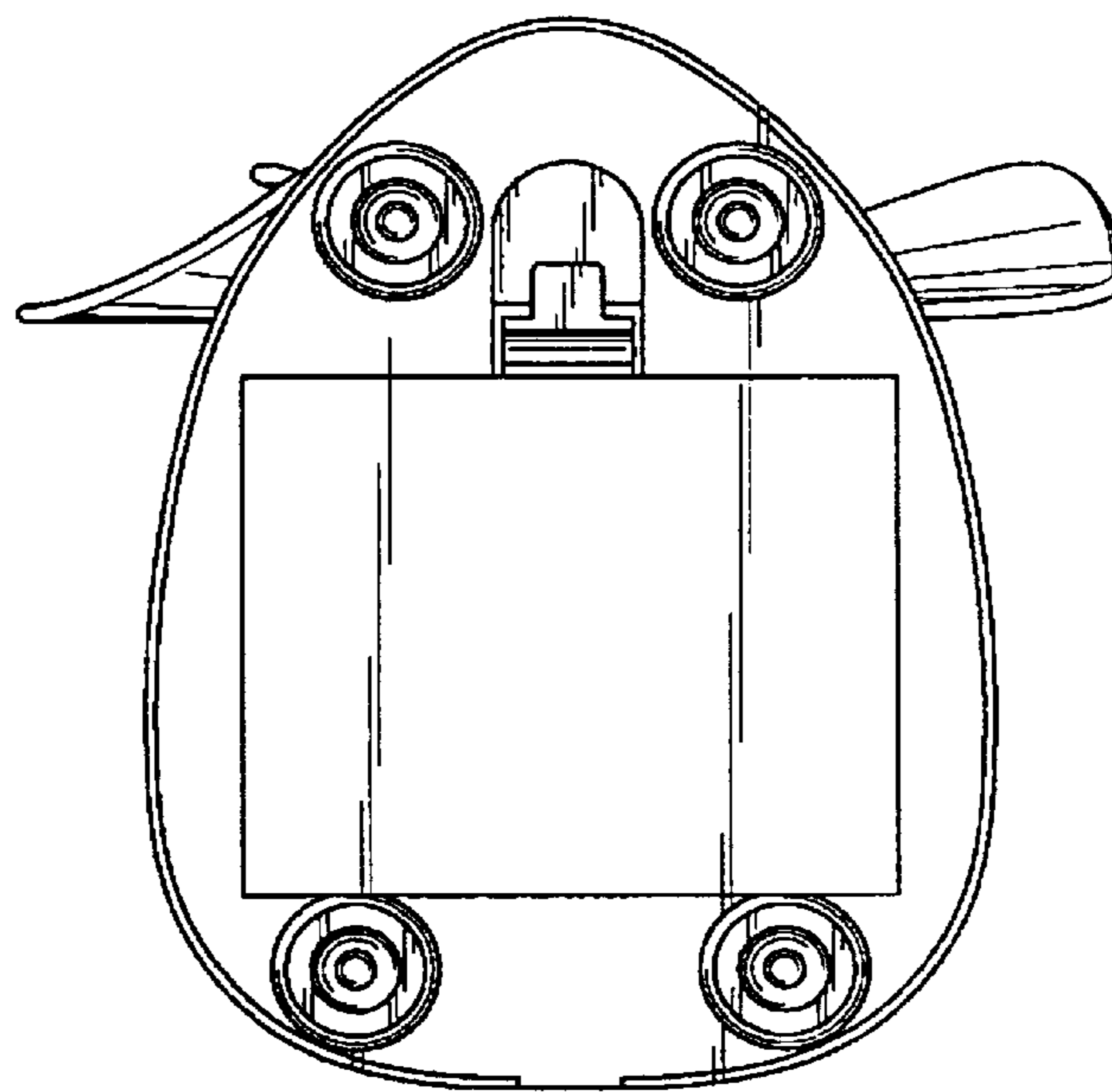

FIG. 7