



US00D486897S

(12) **United States Design Patent**
Rolph et al.

(10) **Patent No.:** **US D486,897 S**

(45) **Date of Patent:** **** Feb. 17, 2004**

(54) **BOILER**

(75) Inventors: **Neil W. Rolph**, LaPorte, IN (US);
Shuqing Cui, Valparaiso, IN (US);
Edward W. Johann, Michigan City, IN (US);
Scott Ryan, Skaneateles, NY (US)

(73) Assignee: **United Dominion Industries, Inc.**,
Charlotte, NC (US)

(**) Term: **14 Years**

(21) Appl. No.: **29/171,644**

(22) Filed: **Nov. 27, 2002**

(51) **LOC (7) Cl.** **23-04**

(52) **U.S. Cl.** **D23/319**

(58) **Field of Search** D23/318, 319,
D23/320, 321, 322; 237/8 R, 8 B, 9 R,
16, 56, 61, 62, 67

(56) **References Cited**

U.S. PATENT DOCUMENTS

D117,291 S	*	10/1939	Sandlas, Jr.	D23/319
D177,049 S	*	3/1956	Janis	D23/319
D311,950 S	*	11/1990	Excell	D23/319

* cited by examiner

Primary Examiner—Brian N. Vinson
(74) *Attorney, Agent, or Firm*—Baker & Hostetler, LLP

(57) **CLAIM**

The ornamental design for a boiler, as shown and described.

DESCRIPTION

FIG. 1 is a perspective view of a first embodiment of the boiler, particularly showing the inventive design thereof; FIG. 2 is a front view thereof; FIG. 3 is a rear view thereof; FIG. 4 is a left side view thereof; FIG. 5 is a right side view thereof; FIG. 6 is a top view thereof; FIG. 7 is a bottom view thereof; FIG. 8 is a perspective view of a second embodiment of the boiler, particularly showing the inventive design thereof; FIG. 9 is a front view thereof; FIG. 10 is a rear view thereof; FIG. 11 is a left side view thereof; FIG. 12 is a right side view thereof; FIG. 13 is a top view thereof; and, FIG. 14 is a bottom view thereof.

1 Claim, 14 Drawing Sheets

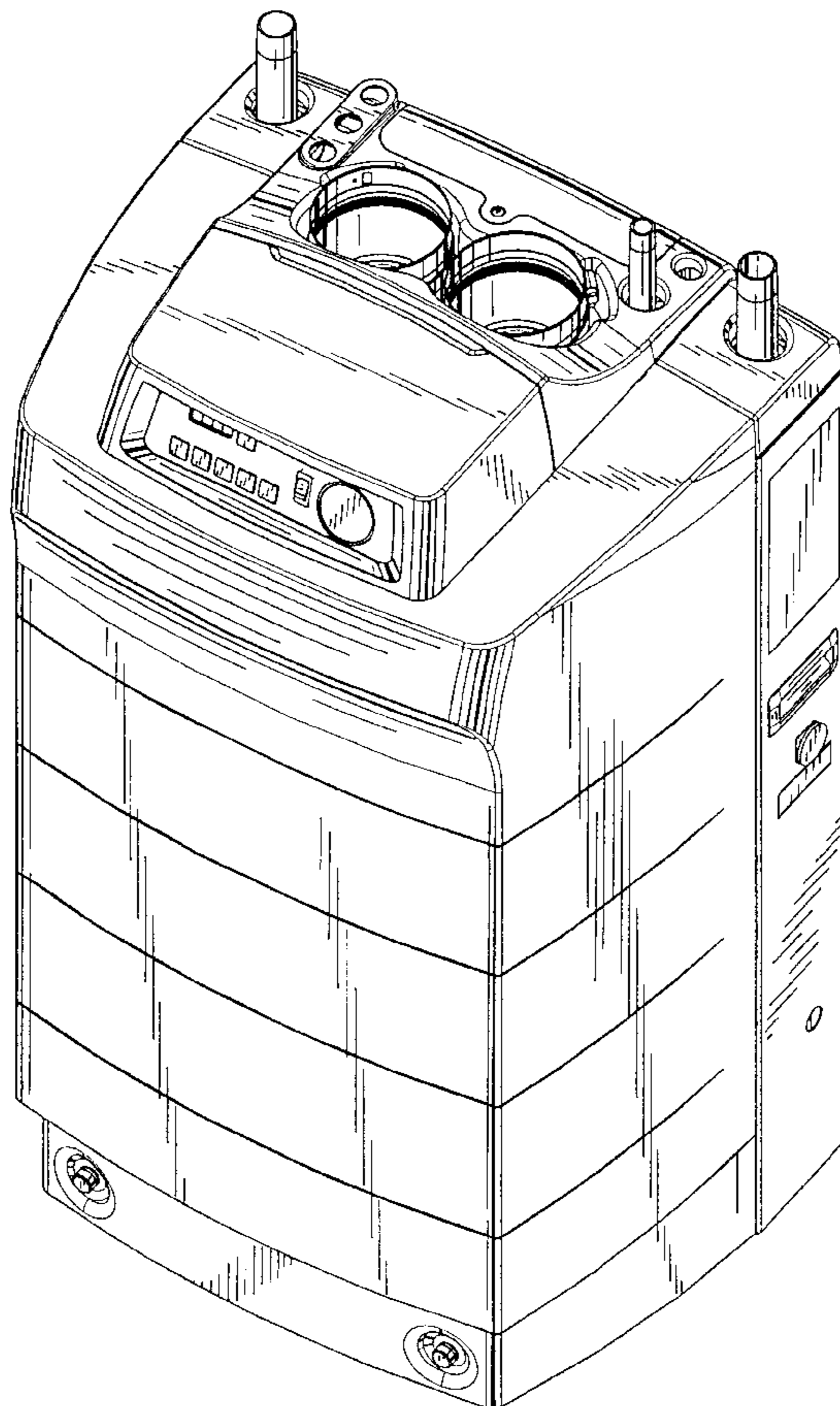

FIG. 1

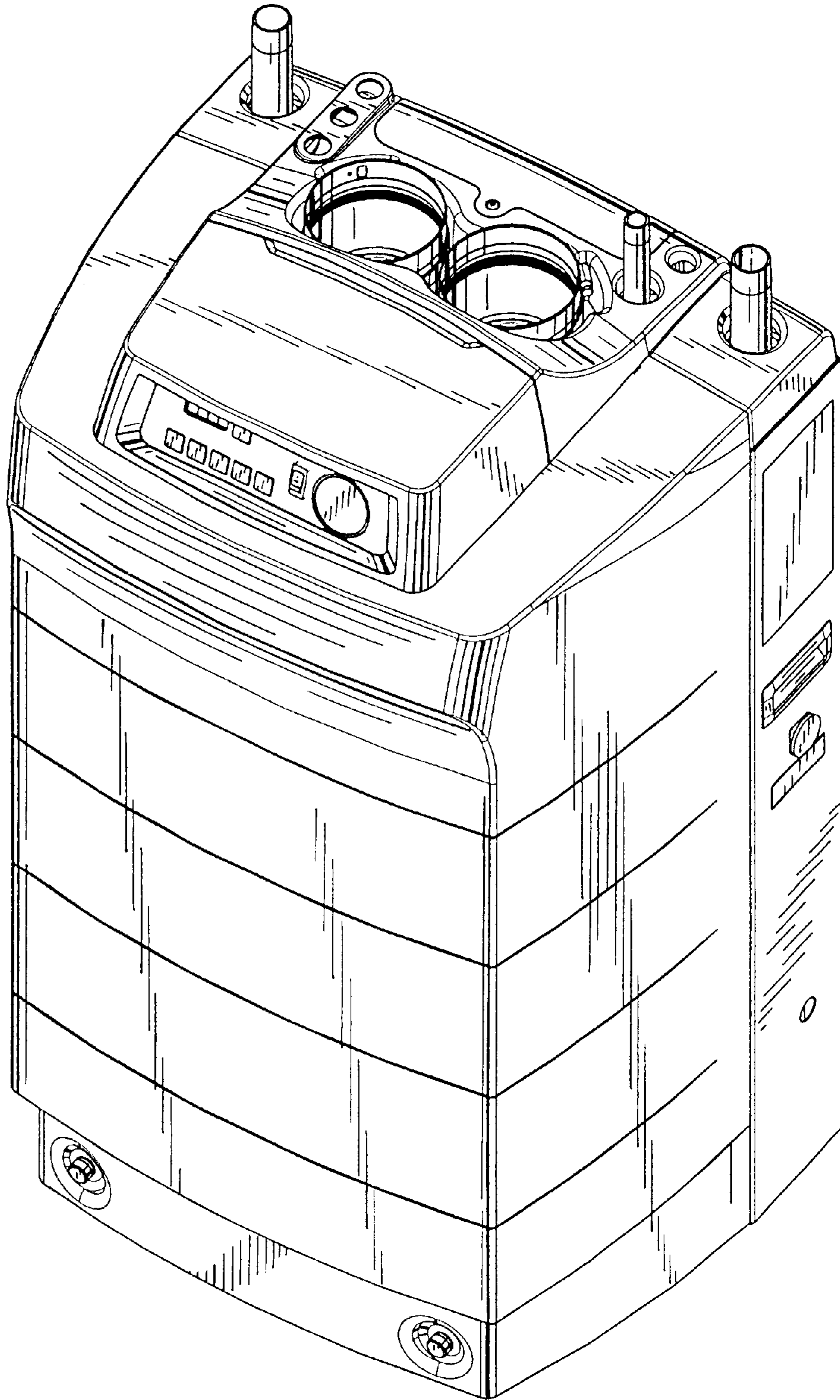

FIG. 2

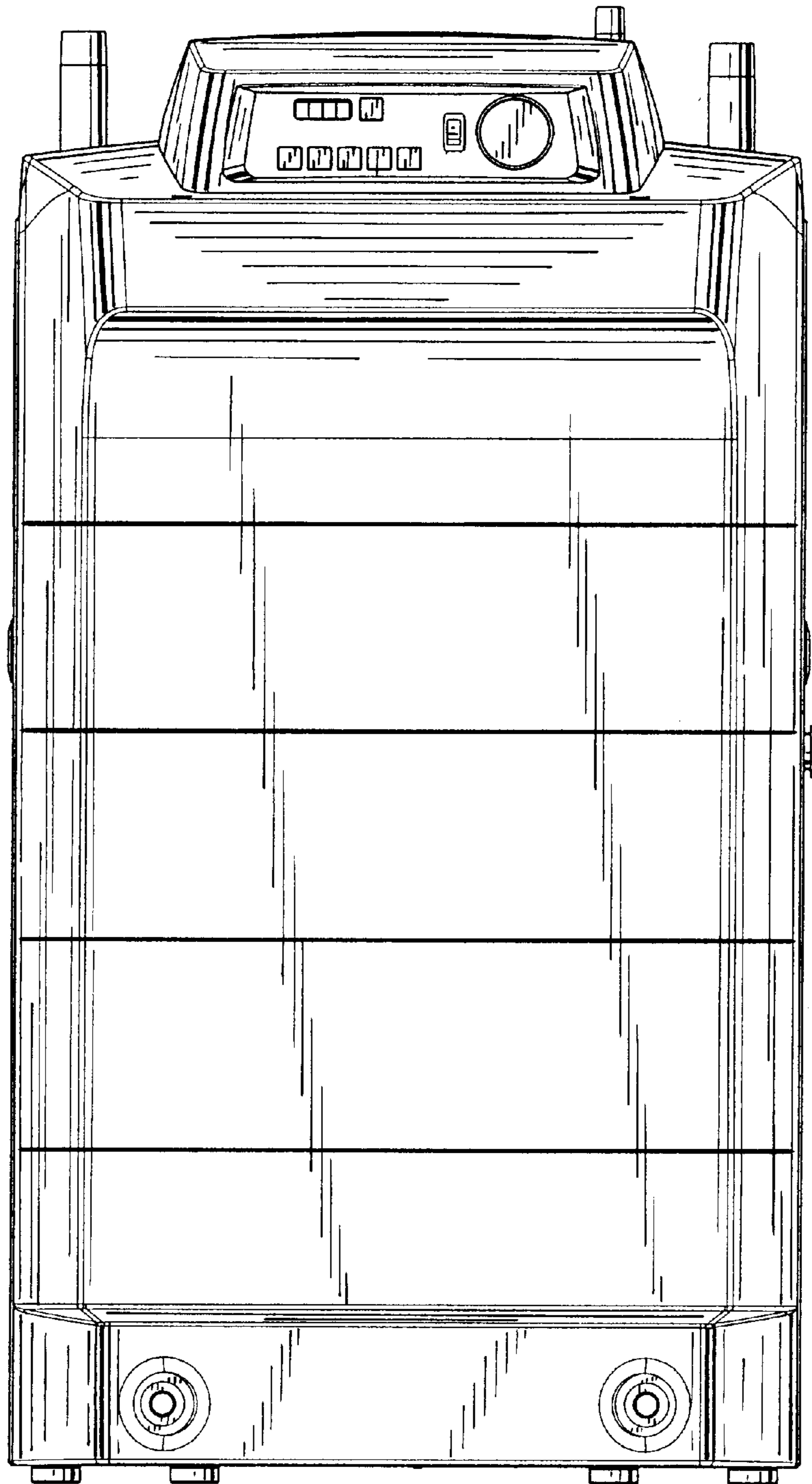

FIG. 3

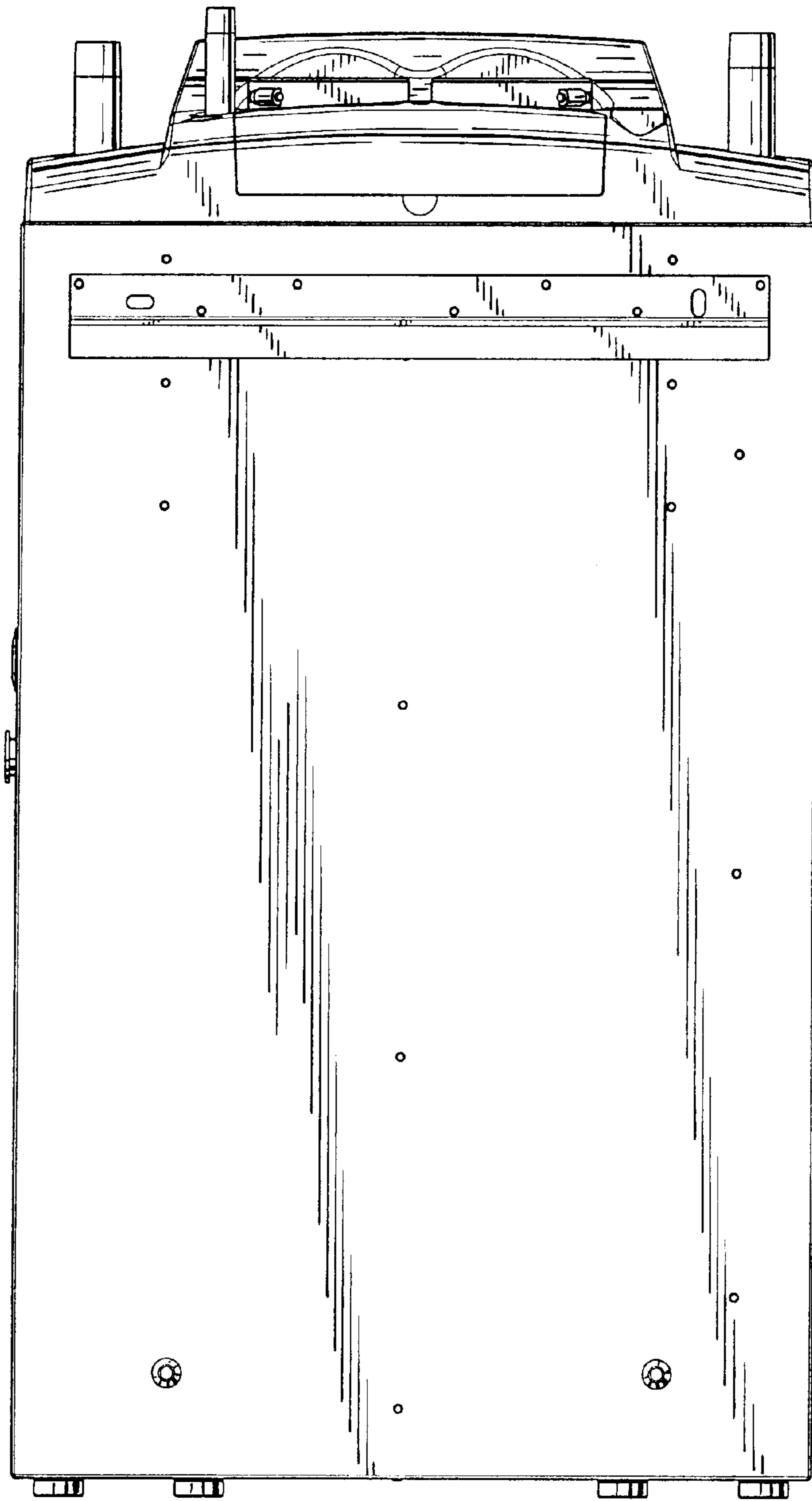

FIG. 4

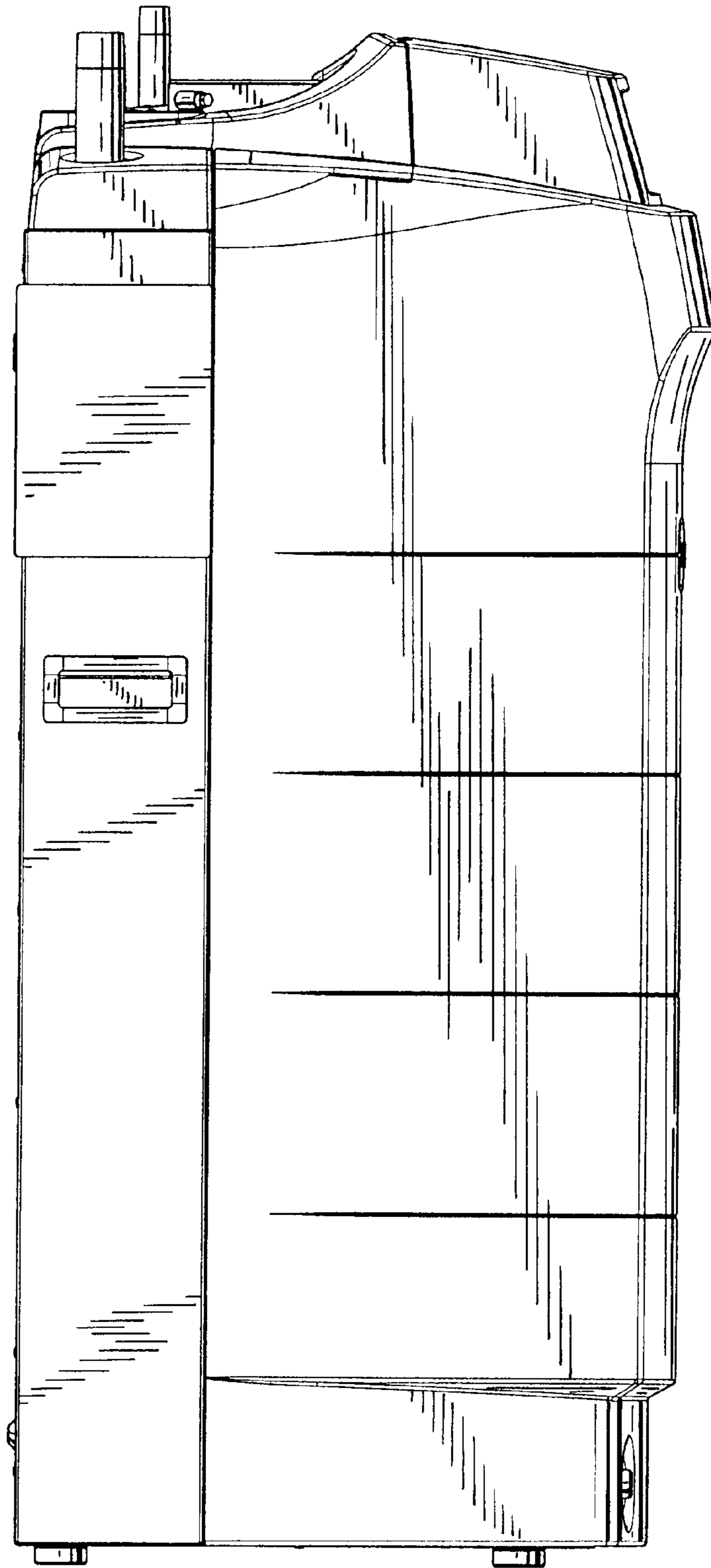

FIG. 5

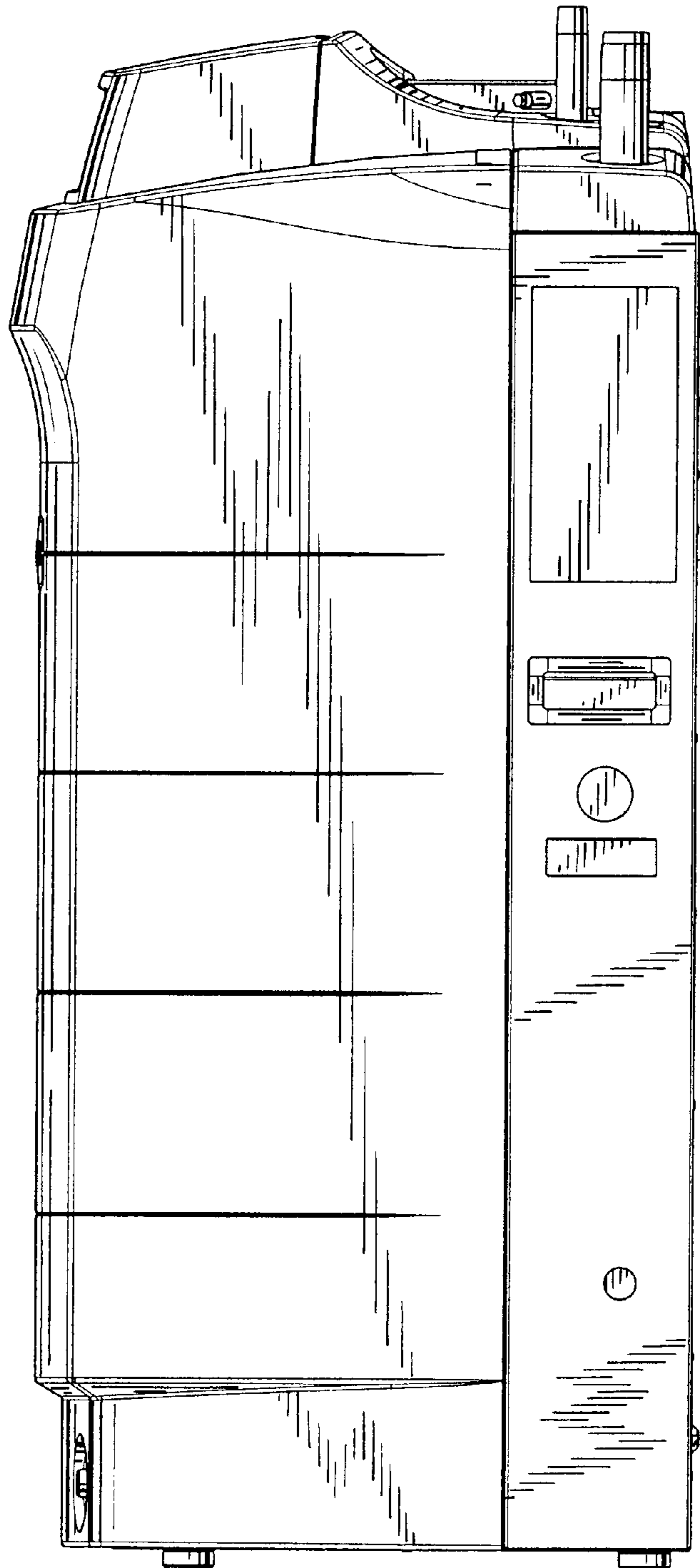

FIG. 6

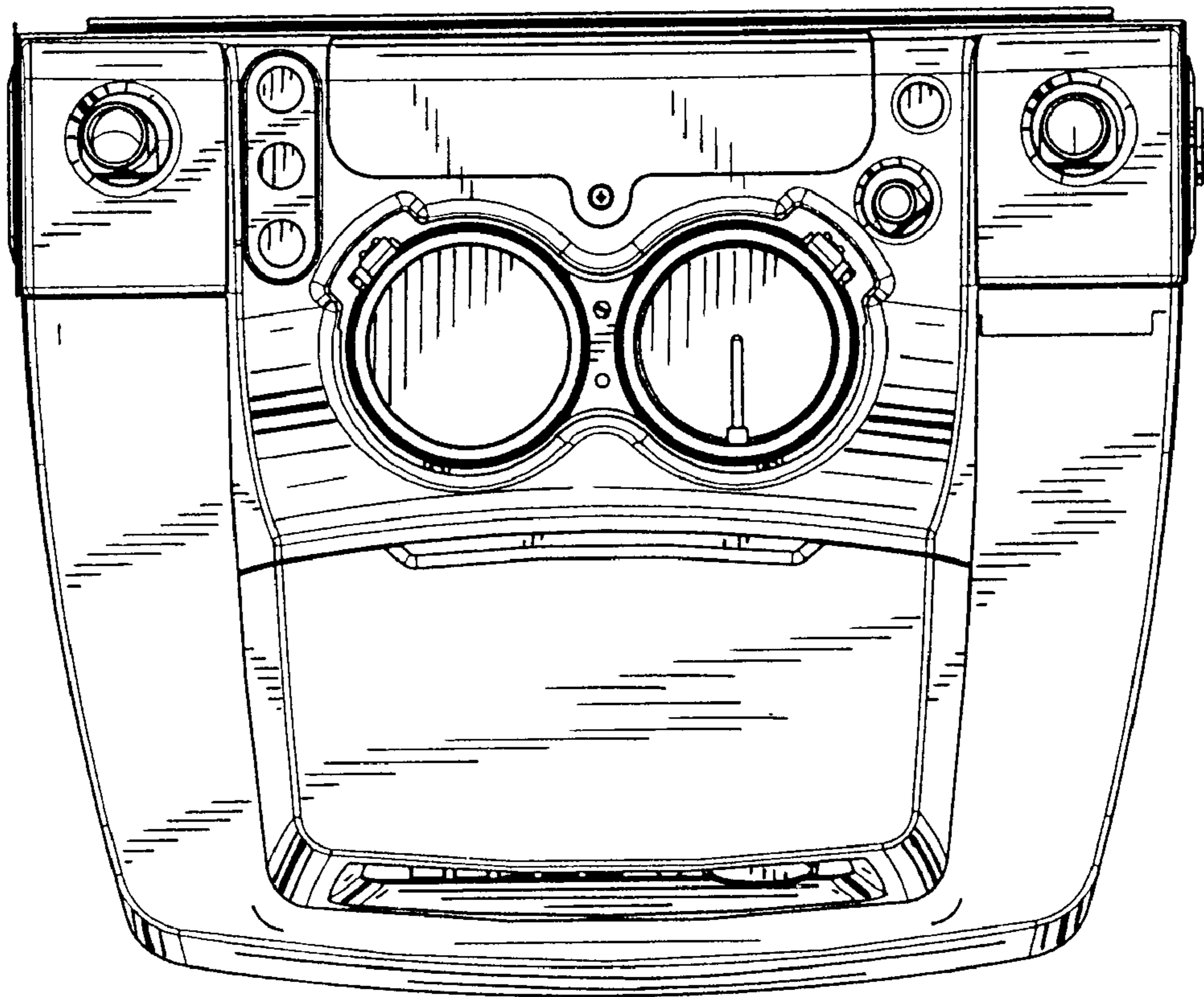

FIG. 7

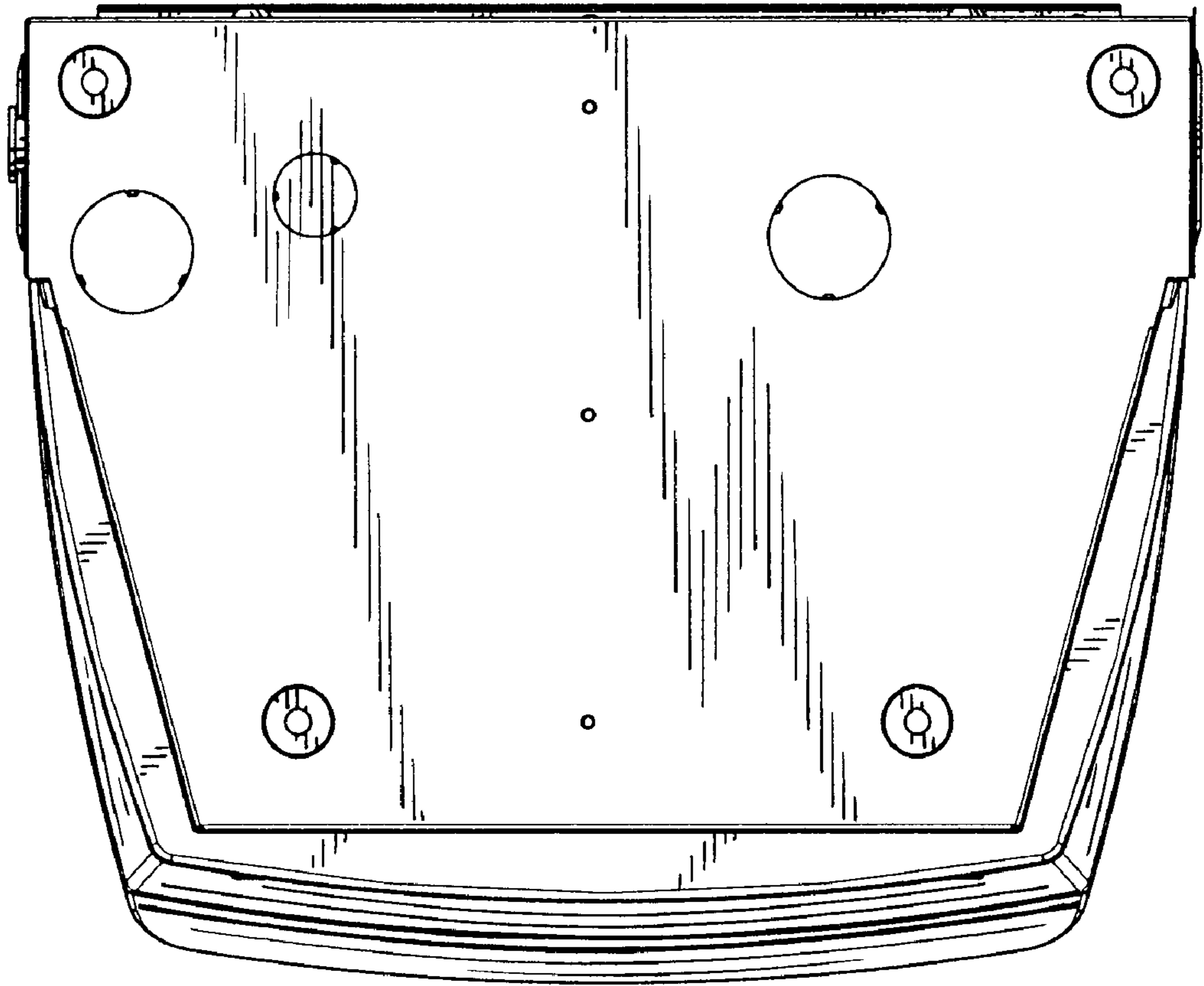

FIG. 8

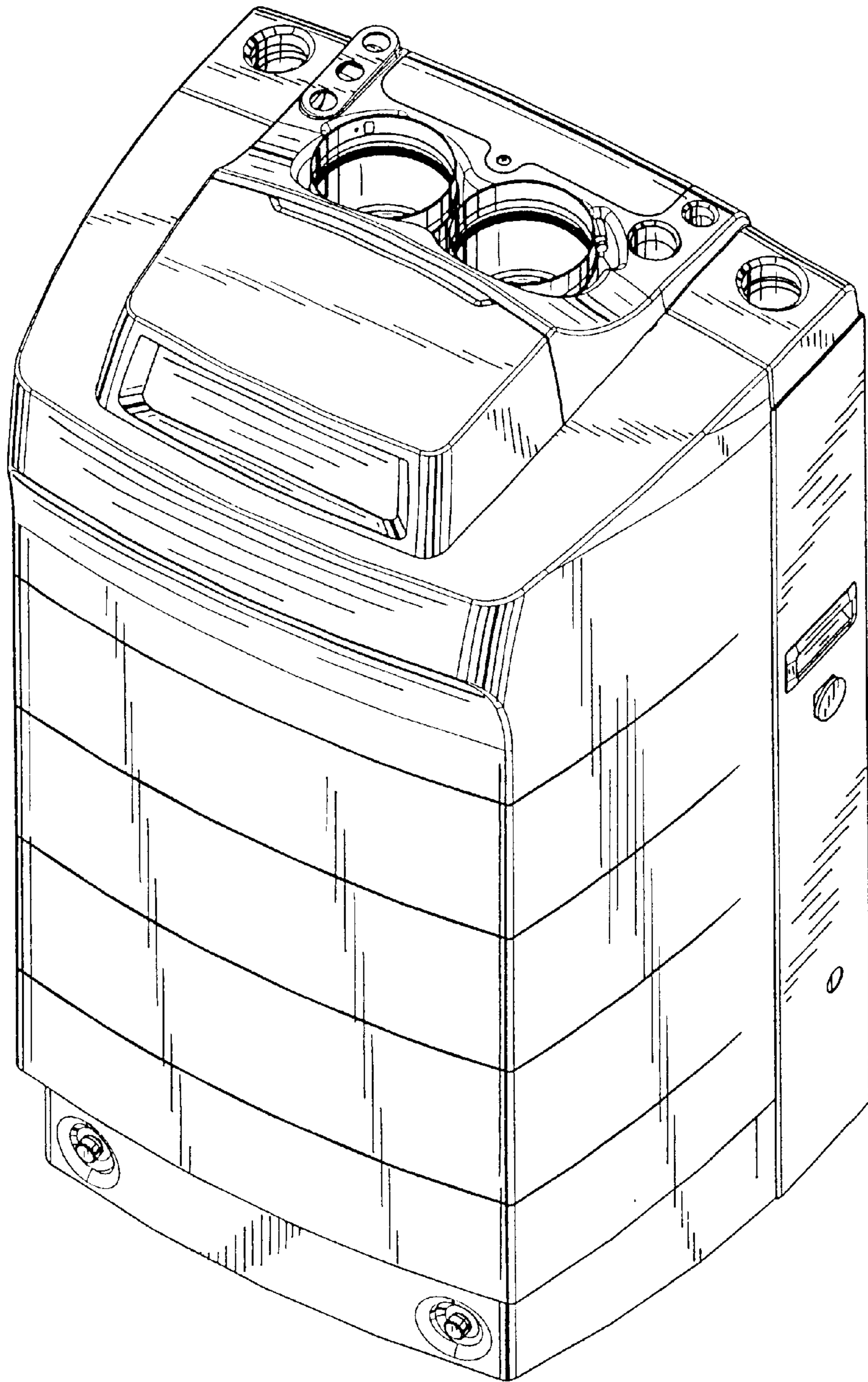

FIG. 9

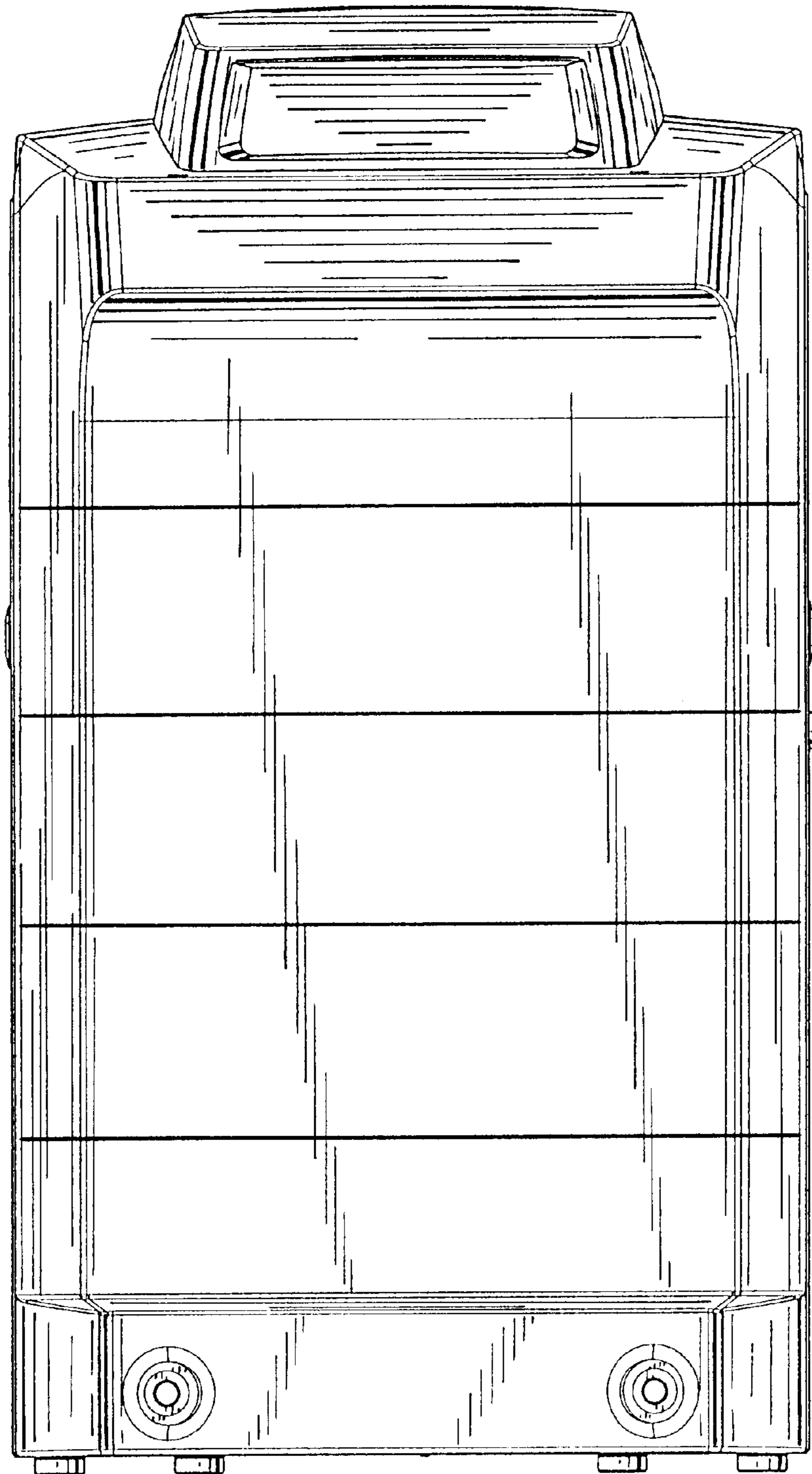

FIG. 10

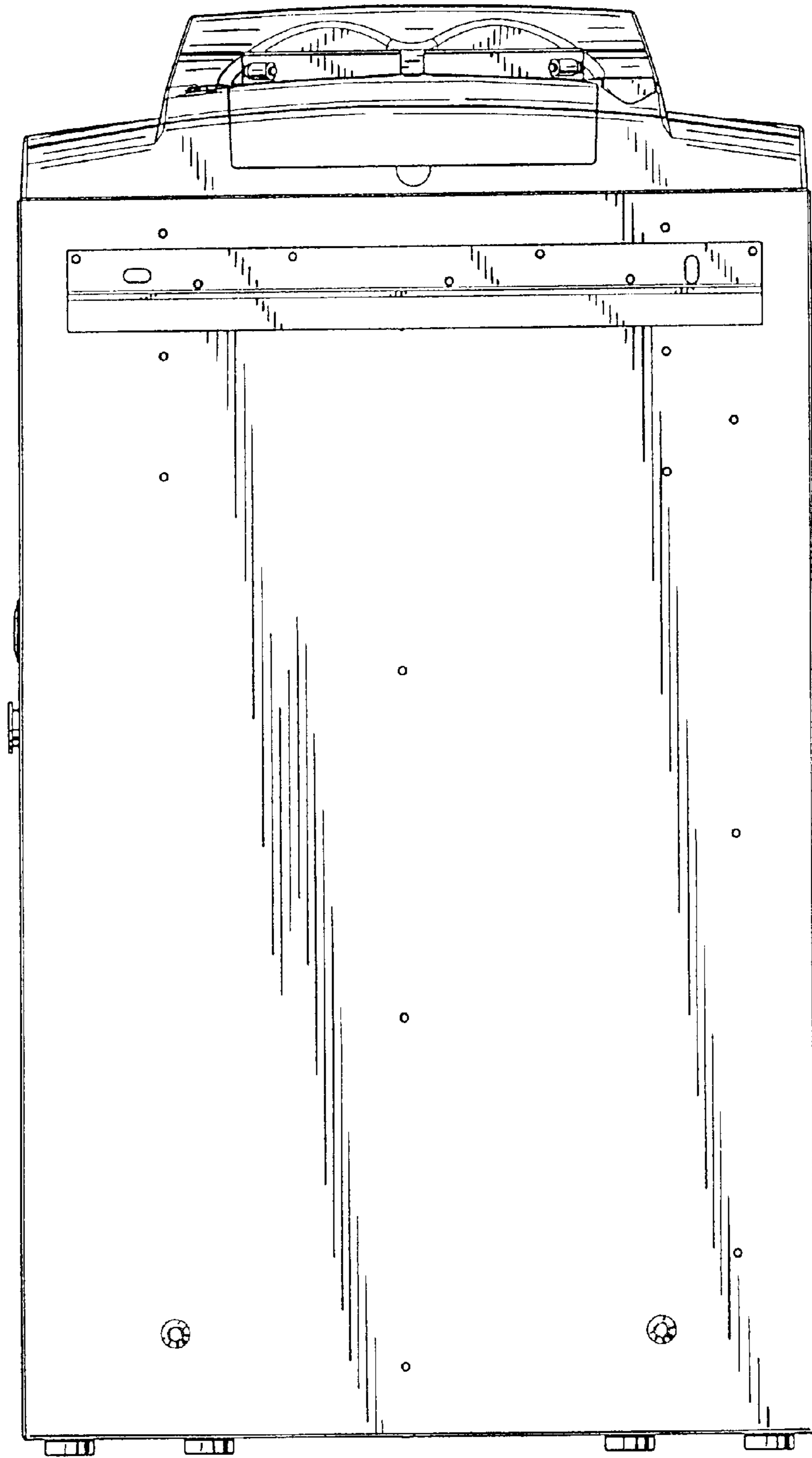

FIG. 11

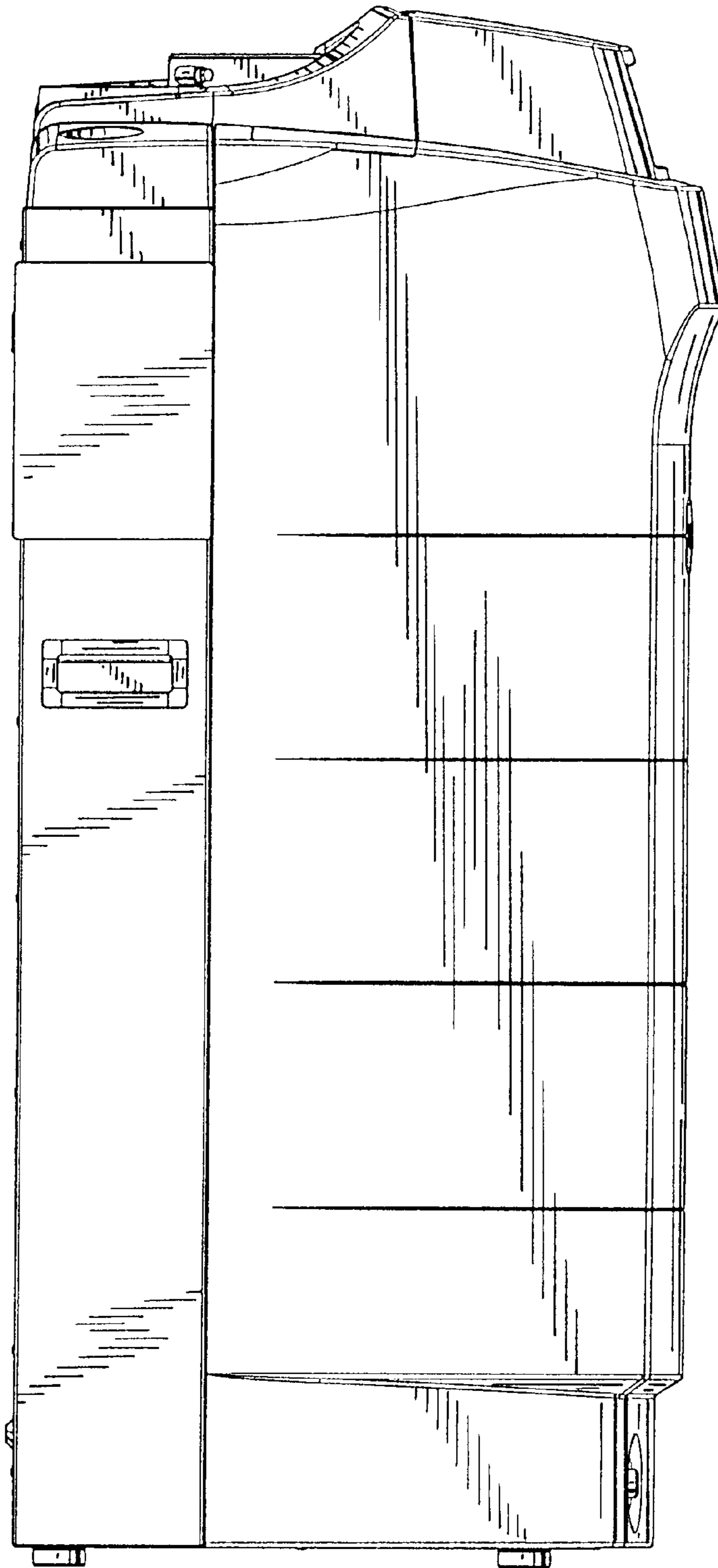

FIG. 12

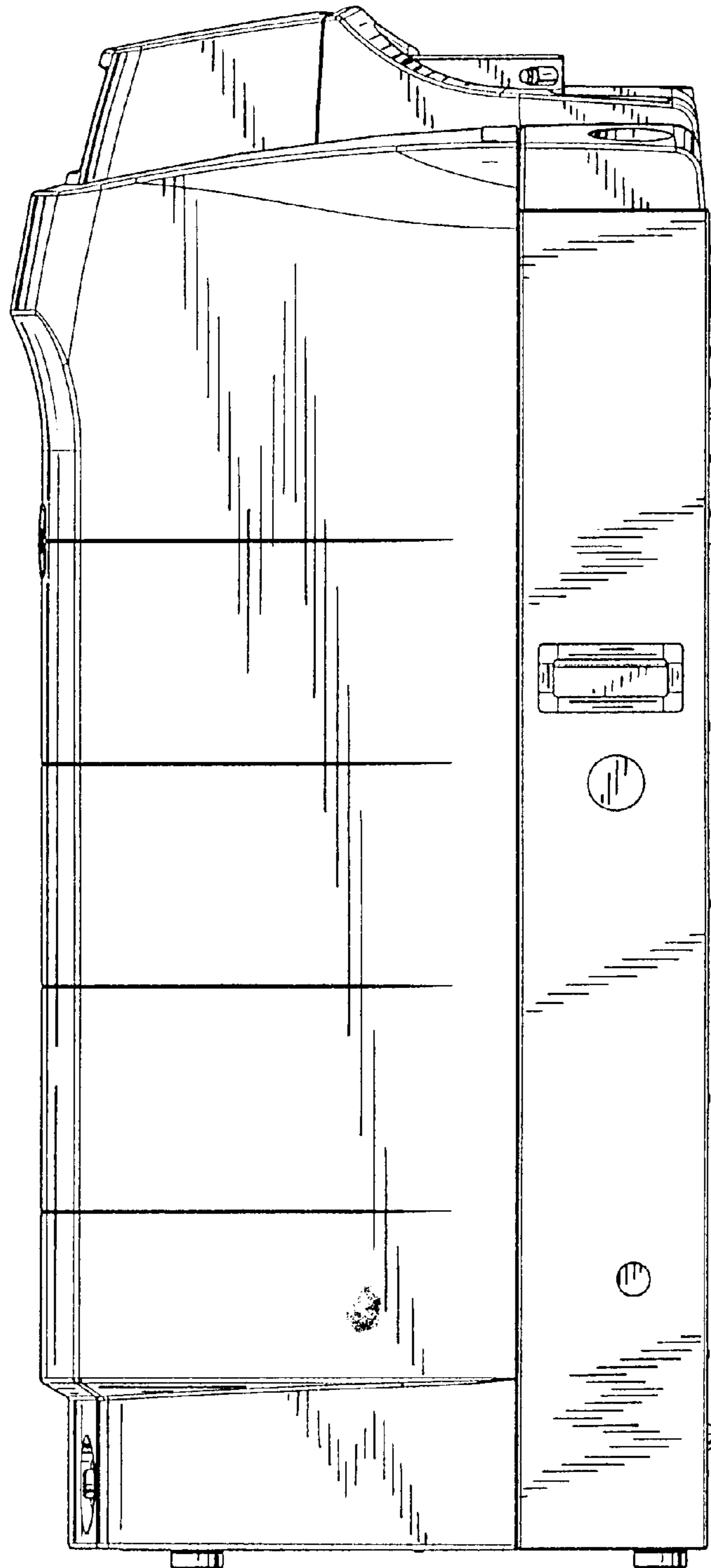

FIG. 13

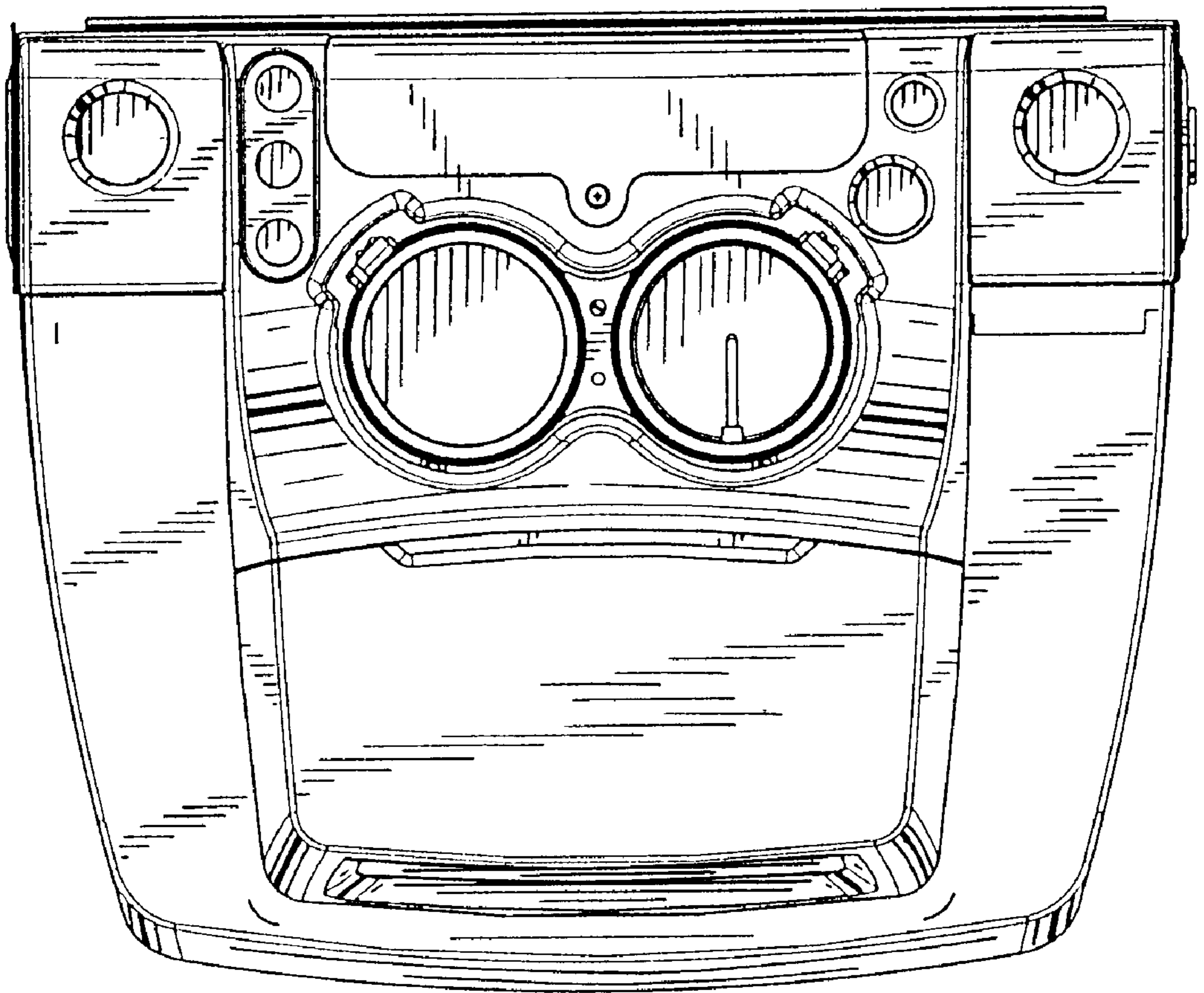

FIG. 14

