



US00D486886S

(12) **United States Design Patent**
Gregory

(10) **Patent No.:** **US D486,886 S**

(45) **Date of Patent:** **** Feb. 17, 2004**

(54) **POP-UP SPRINKLER RUBBER NOZZLE COVER**

(75) Inventor: **Christian T. Gregory**, La Crescenta, CA (US)

(73) Assignee: **Rain Bird Corporation**, Glendora, CA (US)

(**) Term: **14 Years**

(21) Appl. No.: **29/180,365**

(22) Filed: **Apr. 22, 2003**

(51) **LOC (7) Cl.** **23-01**

(52) **U.S. Cl.** **D23/227**

(58) **Field of Search** D23/213, 227;
239/288, 288.3, 288.5

(56) **References Cited**

U.S. PATENT DOCUMENTS

3,762,642 A	*	10/1973	Di Santo	239/201
D391,340 S	*	2/1998	Bernatz	D23/227
D410,731 S	*	6/1999	Bowman et al.	D23/227
5,931,385 A	*	8/1999	Miller	239/288
6,209,803 B1	*	4/2001	Colo'n	239/288.5

* cited by examiner

Primary Examiner—Robin V. Taylor
(74) *Attorney, Agent, or Firm*—John D. Bauersfeld; Kelly Bauersfeld Lowry & Kelley, LLP

(57) **CLAIM**

The ornamental design for a pop-up sprinkler rubber nozzle cover, as shown and described.

DESCRIPTION

FIG. 1 is a perspective view of a rubber cover showing my new design;
FIG. 2 is a front side elevation view of the rubber cover of FIG. 1;
FIG. 3 is a back side elevation view of the rubber cover of FIG. 1;
FIG. 4 is a side elevation view of the rubber cover of FIG. 1;
FIG. 5 is a side elevation view of the rubber cover of FIG. 1 illustrating the side opposite the side illustrated in FIG. 4;
FIG. 6 is a top plan view of the rubber cover of FIG. 1;
FIG. 7 is a perspective view of a modified rubber cover embodying my new design; and,
FIG. 8 is a top plan view of the modified form of the rubber cover shown in FIG. 7.

The bottom of the rubber cover is plain and unornamented. The dominant feature of design resides in the rubber cover.

1 Claim, 4 Drawing Sheets

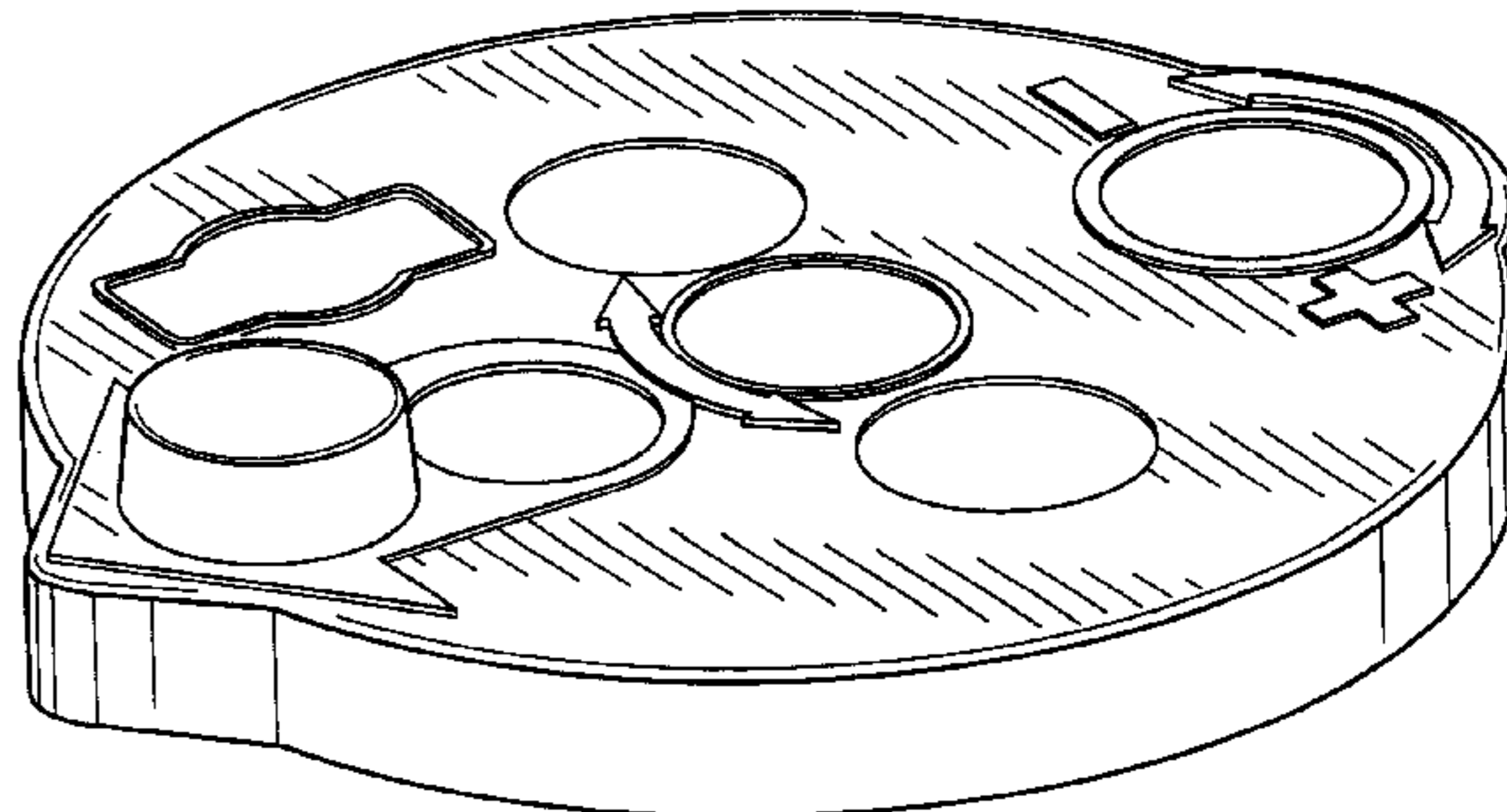
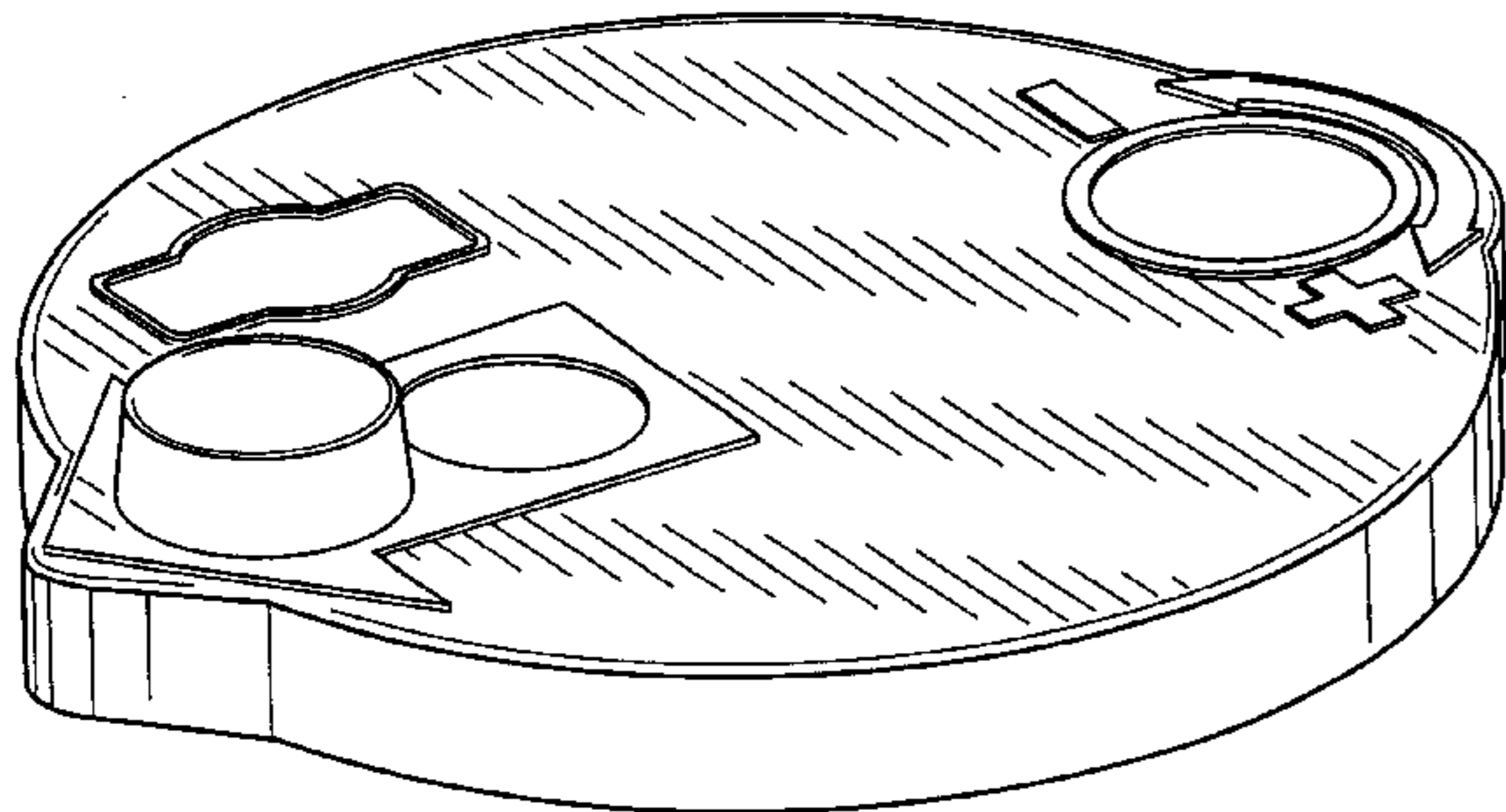

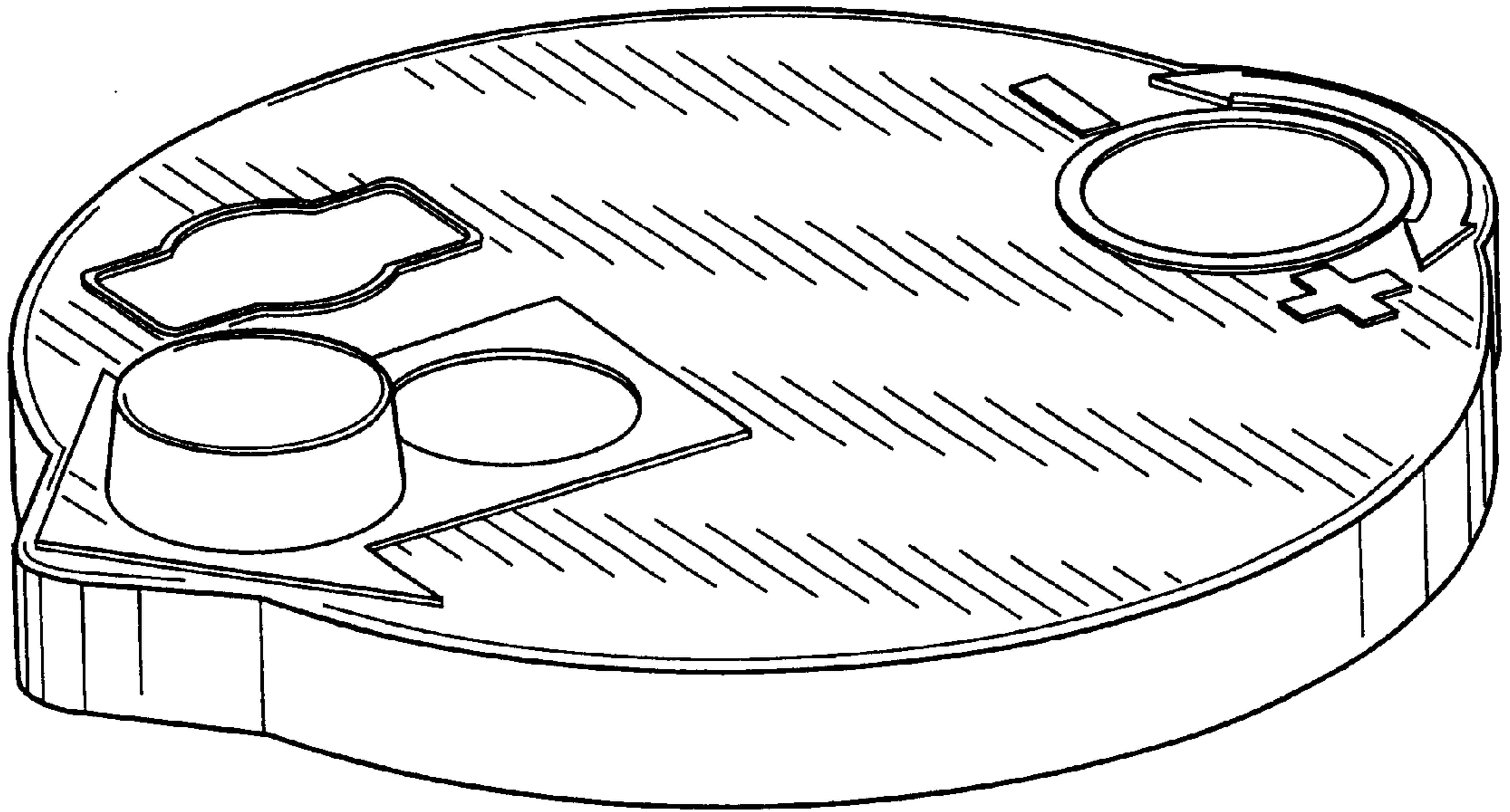

FIG. 1

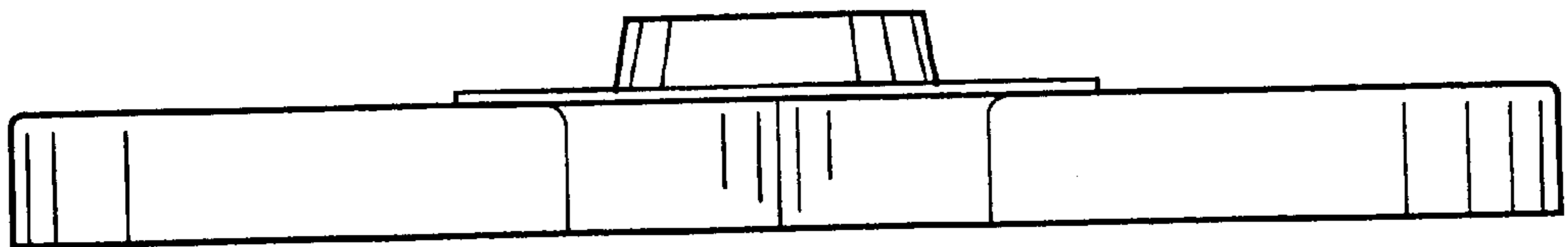

FIG. 2

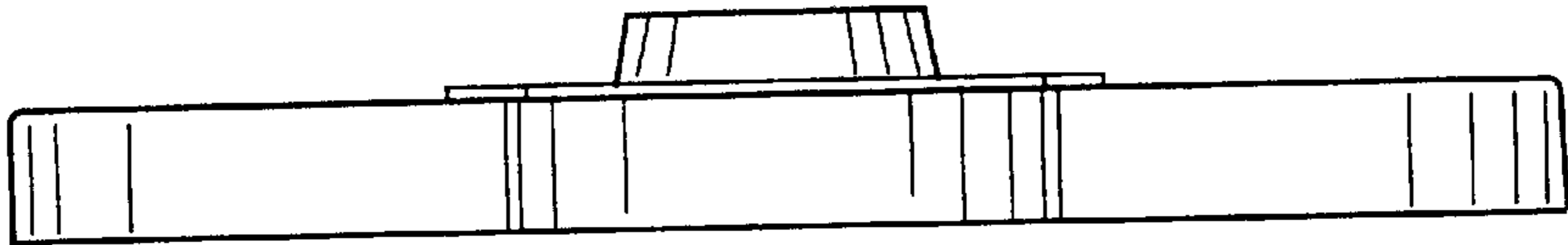

FIG. 3

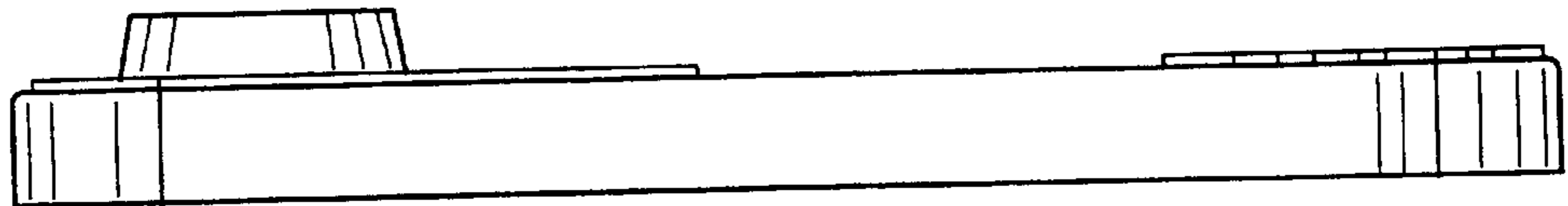

FIG. 4

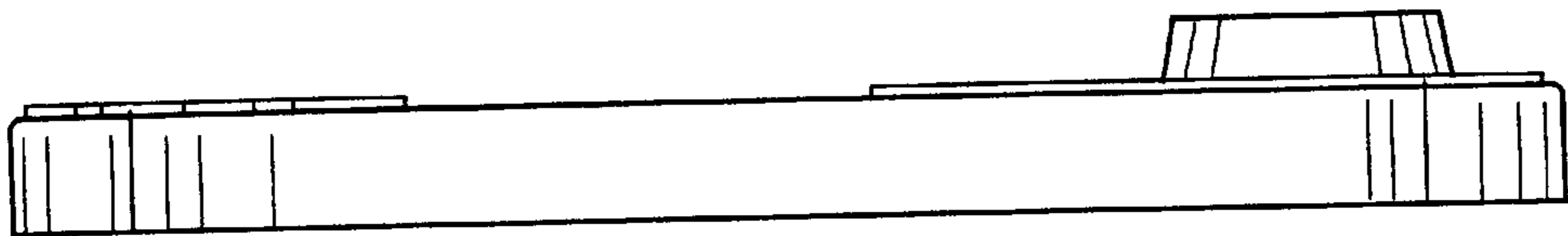

FIG. 5

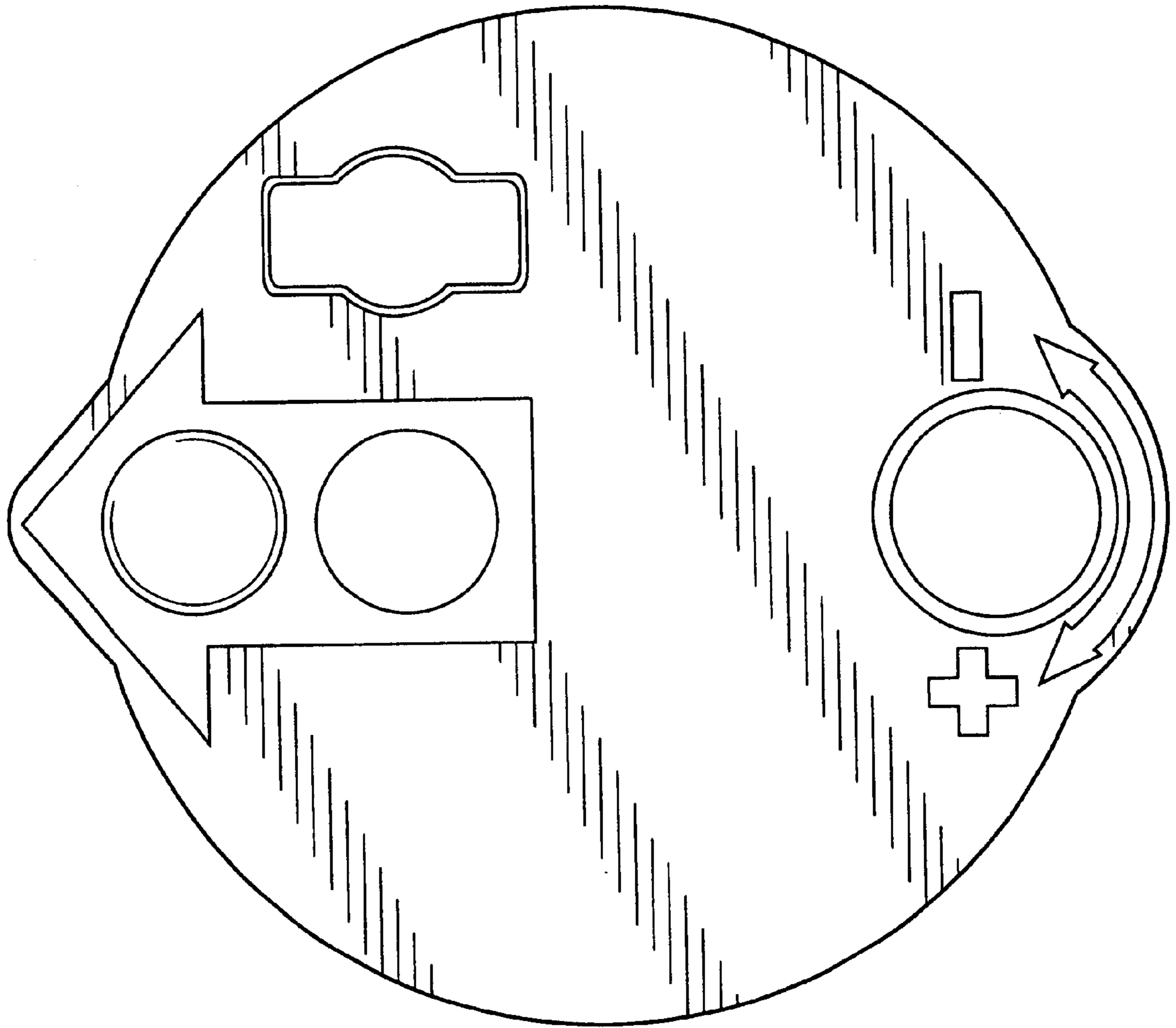

FIG. 6

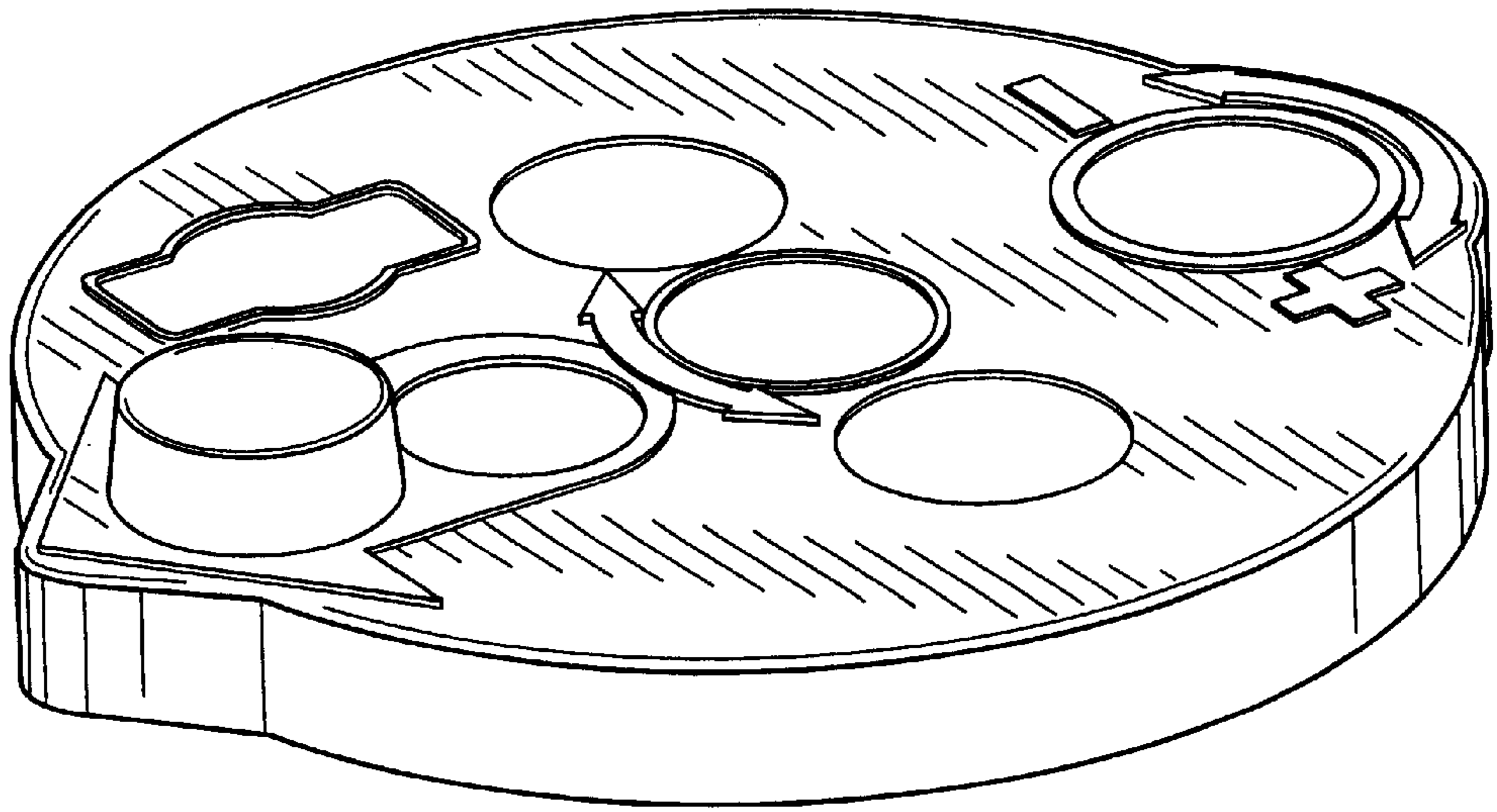

FIG. 7

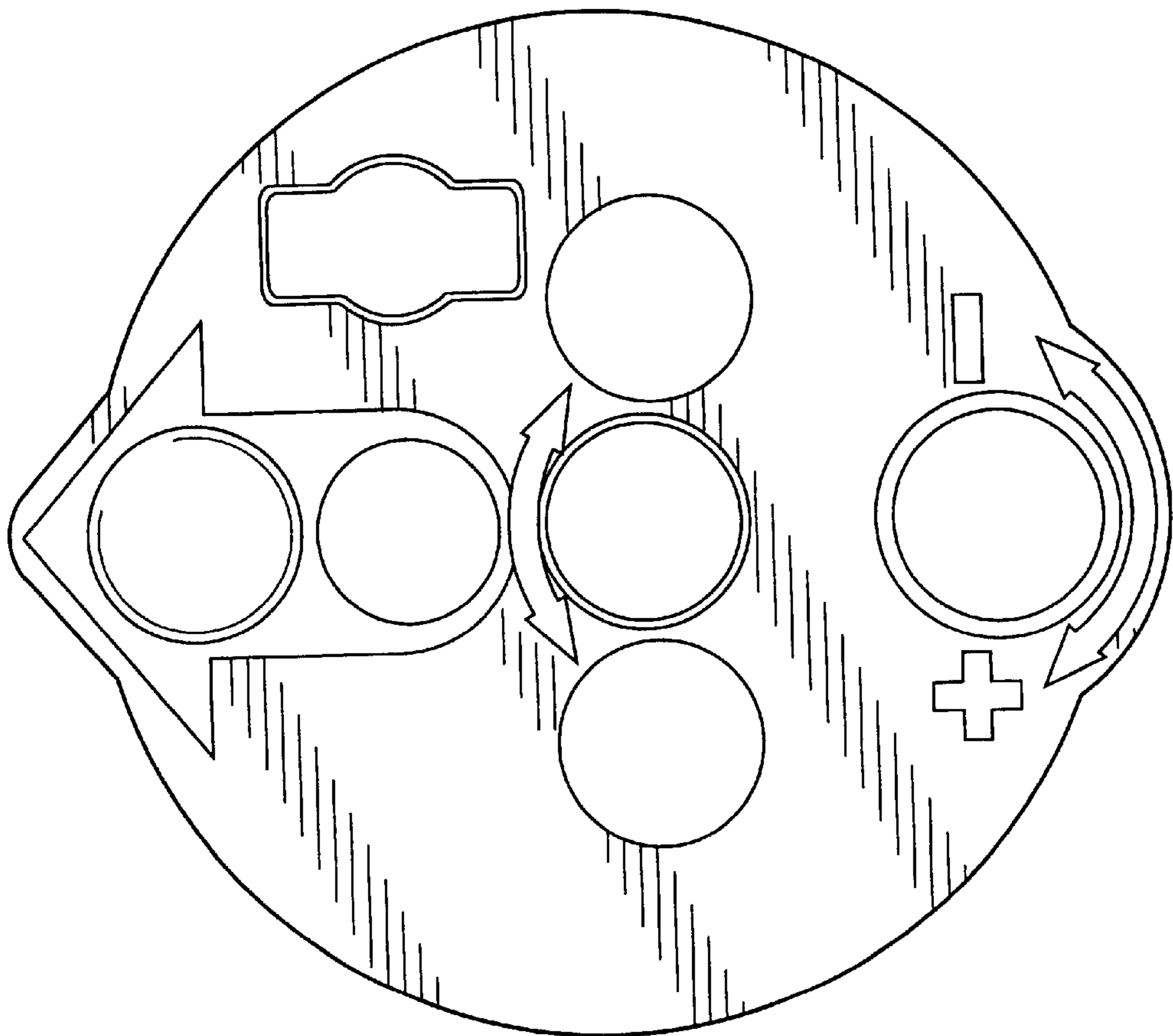

FIG. 8