



US00D486763S

(12) **United States Design Patent**
Nunez

(10) **Patent No.:** **US D486,763 S**

(45) **Date of Patent:** **** Feb. 17, 2004**

(54) **DIFFERENTIAL AND AXLE GUARD**

(76) Inventor: **Roman Raul Nunez**, 821 W. Acadia,
Tucson, AZ (US) 85706

(**) Term: **14 Years**

(21) Appl. No.: **29/180,782**

(22) Filed: **Apr. 30, 2003**

(51) **LOC (7) Cl.** **12-16**

(52) **U.S. Cl.** **D12/160**

(58) **Field of Search** D12/159-162,
D12/181, 182, 190, 400, 197, 217; 280/847,
848; 269/203, 204, 33

(56) **References Cited**

U.S. PATENT DOCUMENTS

| | | | | | |
|------------|---|---------|---------------|-------|---------|
| D31,641 S | * | 10/1899 | McAllister | | D12/160 |
| D33,649 S | * | 12/1900 | Lowe | | D12/160 |
| D311,511 S | * | 10/1990 | Craig | | D12/162 |
| D319,204 S | * | 8/1991 | McGrady | | D12/162 |
| D407,357 S | * | 3/1999 | Ratcliff, Jr. | | D12/160 |

* cited by examiner

Primary Examiner—Stacia Cadmus

(74) *Attorney, Agent, or Firm*—Gavin J. Milczarek-Desai;
Durando Birdwell & Janke

(57) **CLAIM**

The ornamental design for a differential and axle guard, as shown and described.

DESCRIPTION

FIG. 1 is a front perspective view of a differential and axle guard showing my design, wherein the phantom lines, which are not part of the design, represent a means for attaching the guard to a vehicle chassis;

FIG. 2 is a top plan view thereof;

FIG. 3 is a bottom plan view thereof;

FIG. 4 is an elevational back view thereof;

FIG. 5 is an elevational front view thereof;

FIG. 6 is an elevational right view thereof; and,

FIG. 7 is an elevational left view thereof.

1 Claim, 5 Drawing Sheets

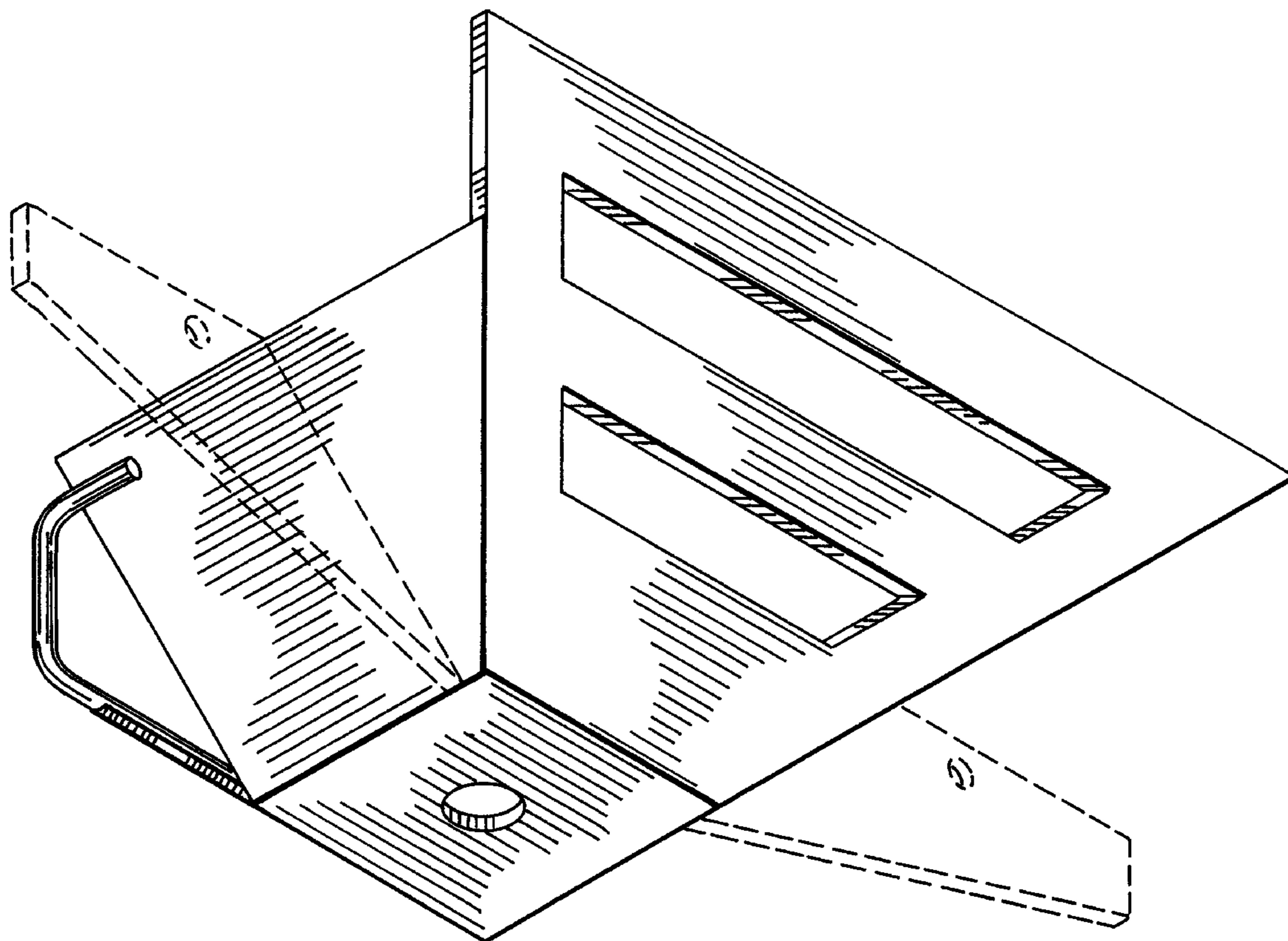

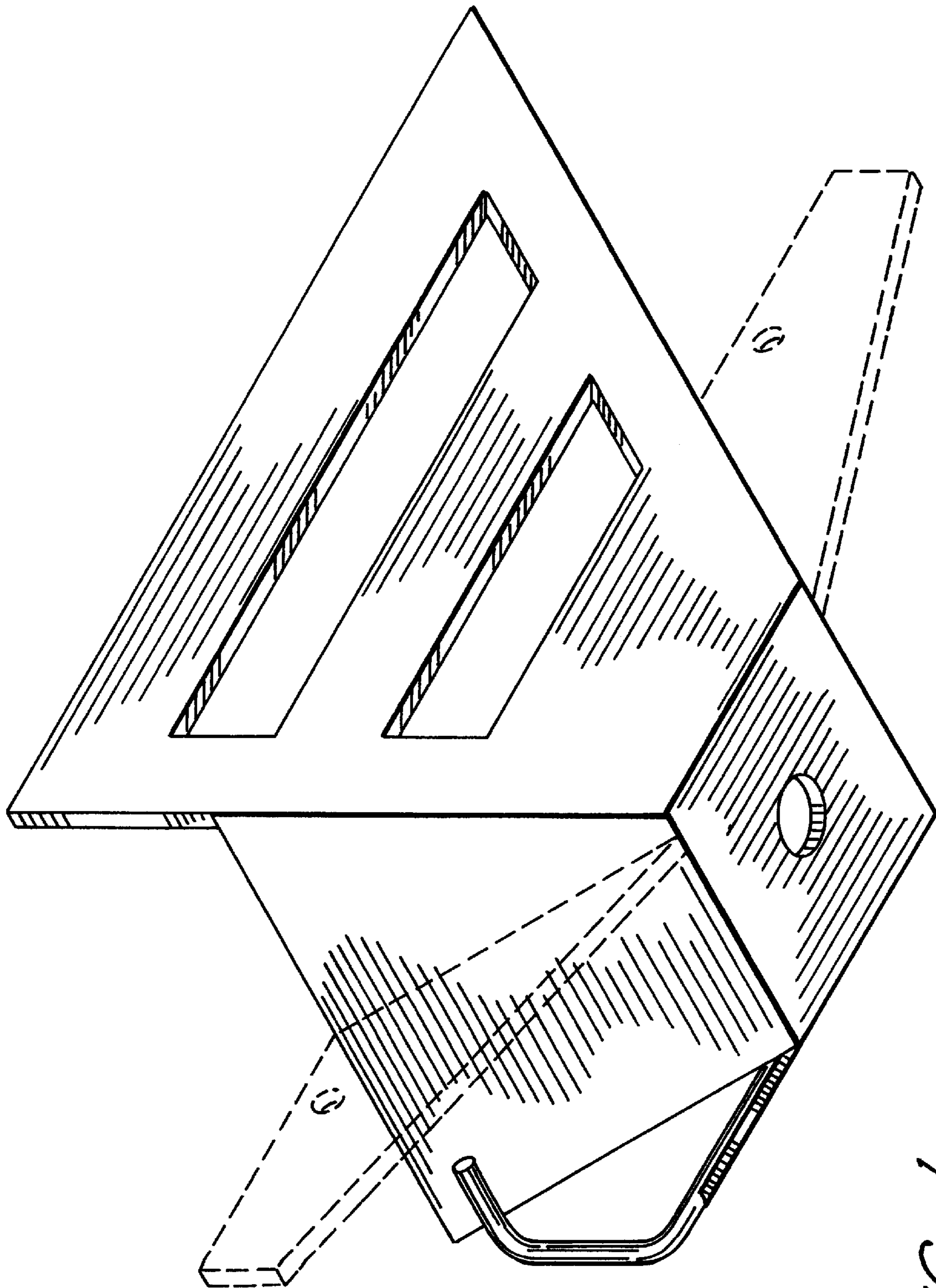

FIG. 1

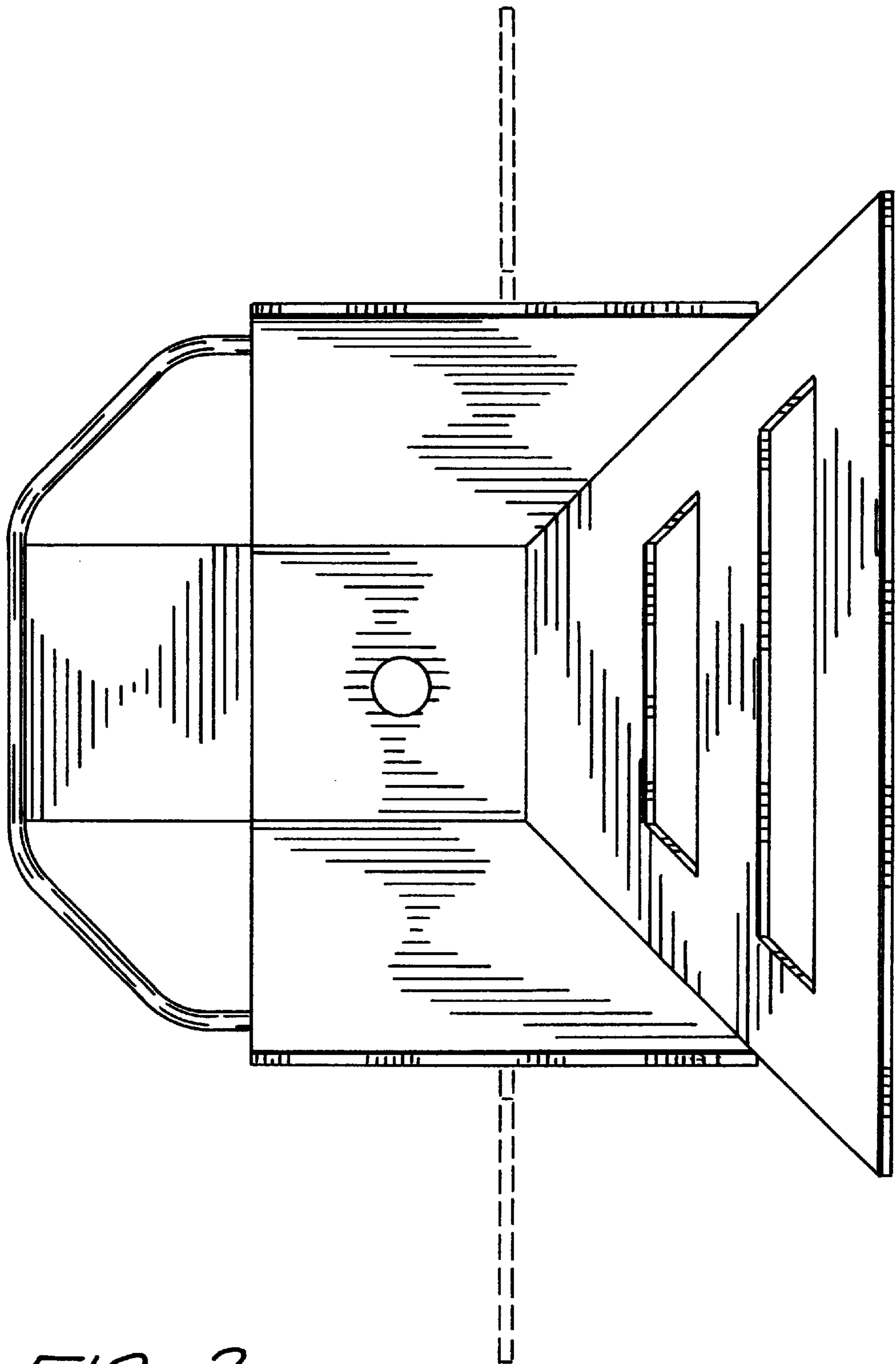

FIG. 2

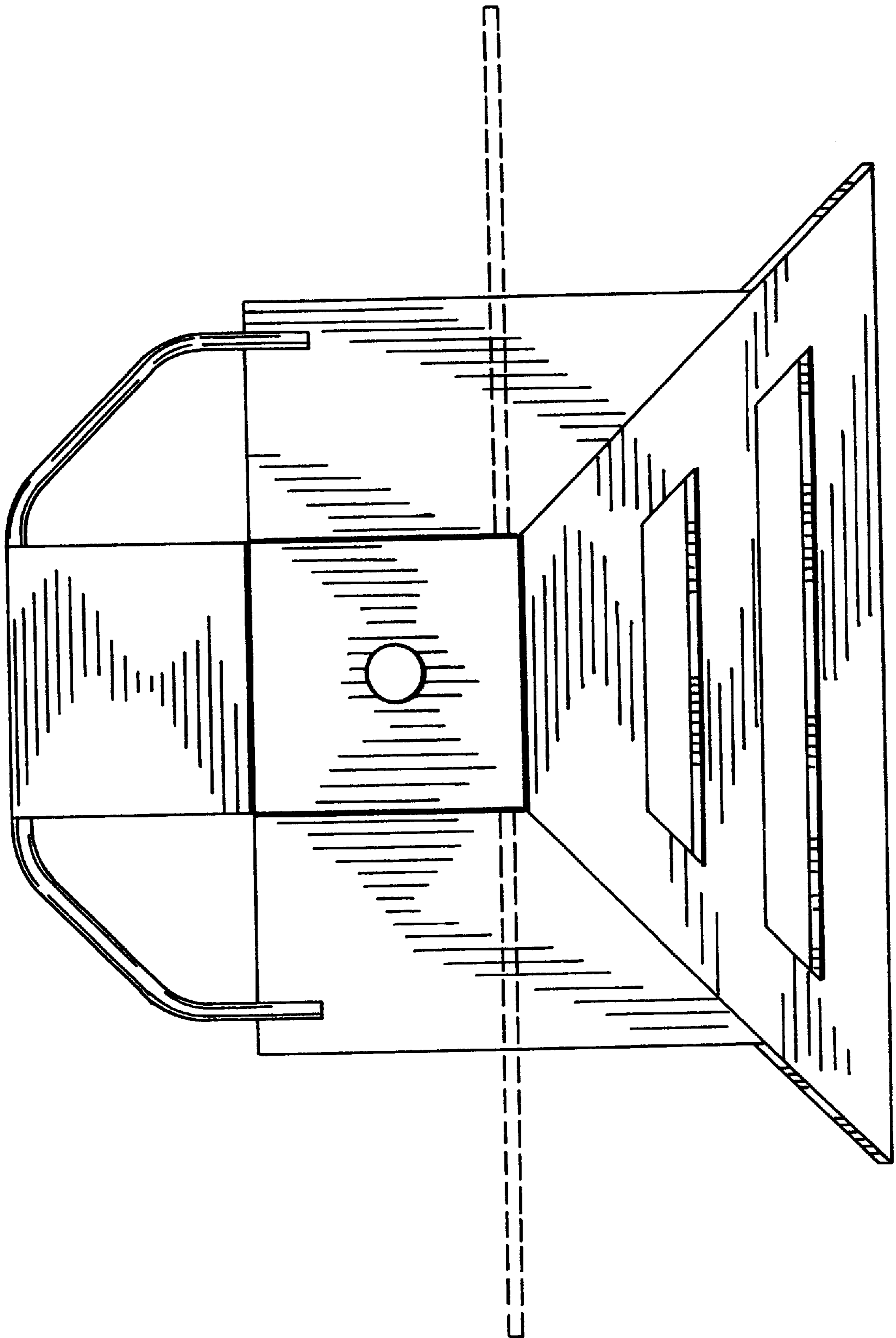

FIG. 3

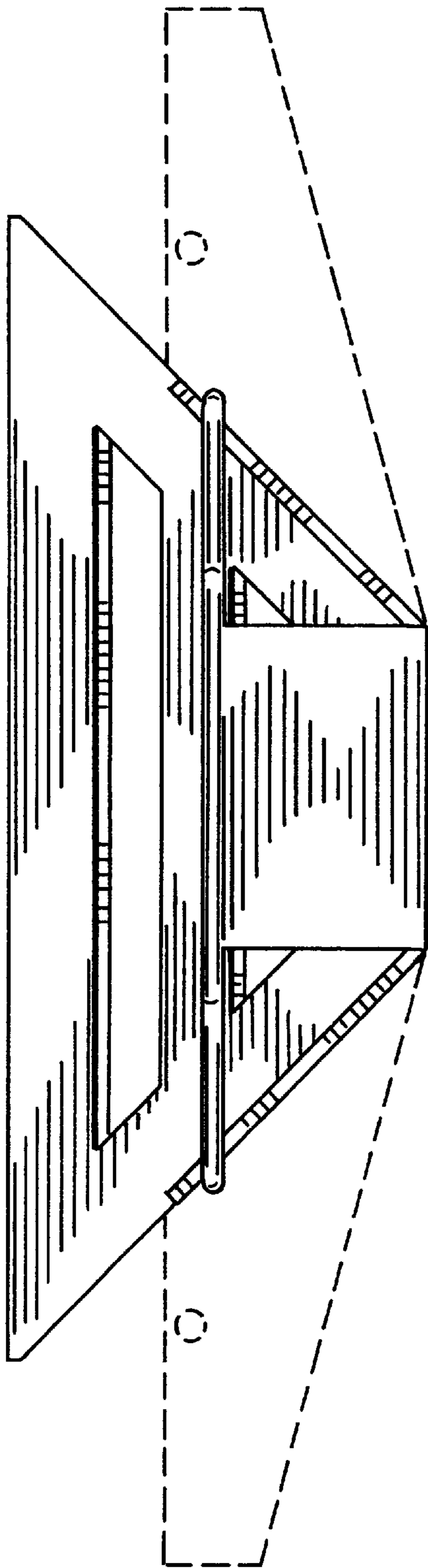

FIG. 4

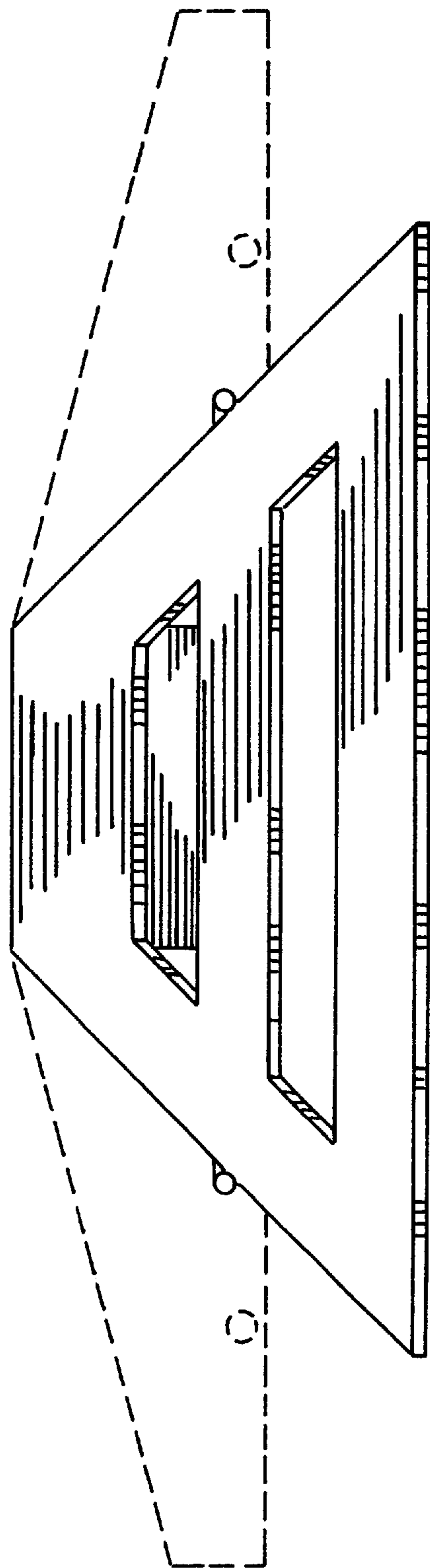

FIG. 5

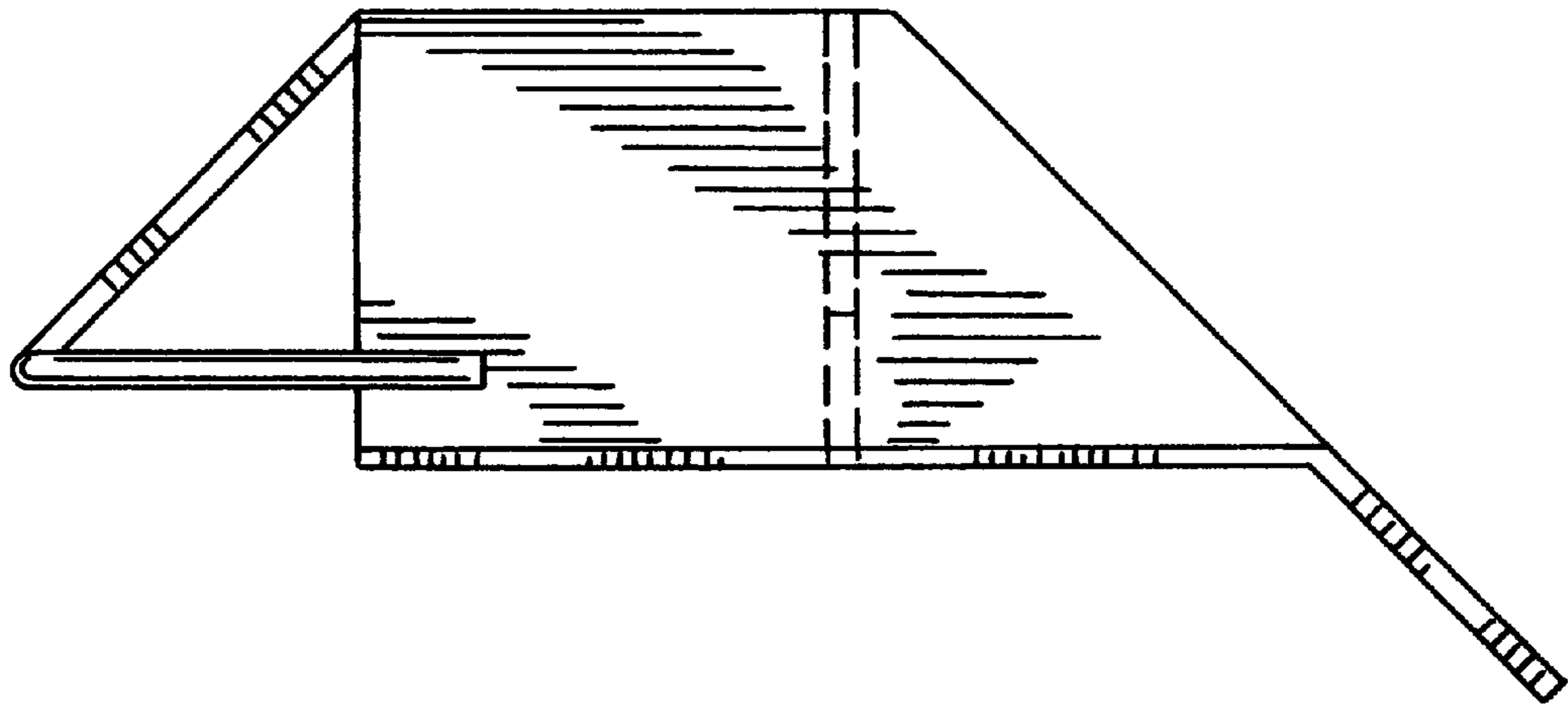

FIG. 6

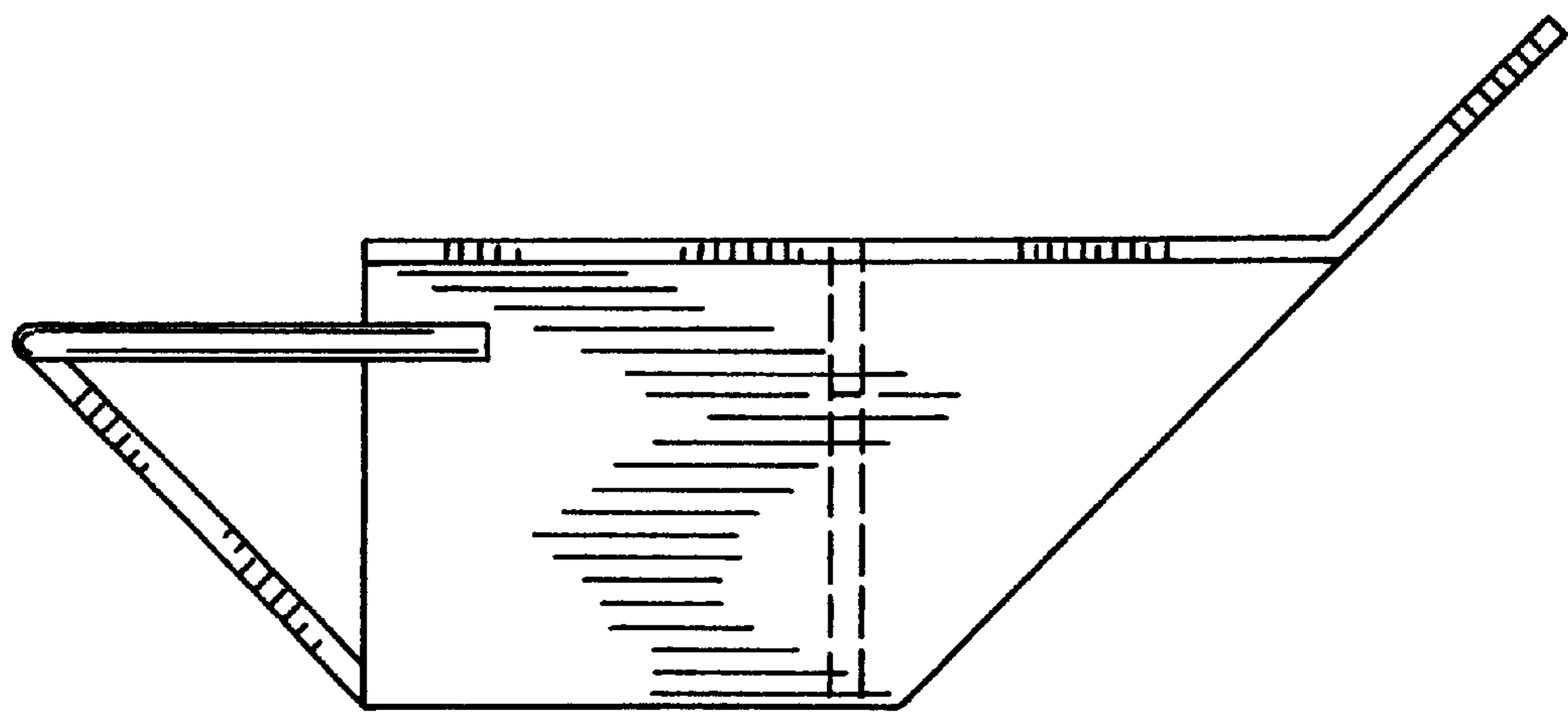

FIG. 7