



US00D486730S

(12) **United States Design Patent**  
**Rasmussen**

(10) **Patent No.:** **US D486,730 S**

(45) **Date of Patent:** **\*\* Feb. 17, 2004**

(54) **PACKAGE**

(75) Inventor: **Ulrik Skovgaard Rasmussen,**  
Middelfart (DK)

(73) Assignee: **Dandy A/S (DK)**

(\*\*) Term: **14 Years**

(21) Appl. No.: **29/167,080**

(22) Filed: **Sep. 9, 2002**

(30) **Foreign Application Priority Data**

Mar. 8, 2002 (DK) ..... DA 2002 00193

(51) **LOC (7) Cl.** ..... **09-05**

(52) **U.S. Cl.** ..... **D9/305**

(58) **Field of Search** ..... D9/305, 415, 418;  
D3/272, 273, 283, 299, 303; 150/131, 138,  
144, 150; 206/219, 521, 524.4; D19/32,  
33

(56) **References Cited**

**U.S. PATENT DOCUMENTS**

3,230,993	A	*	1/1966	Smith et al.	.....	150/131
3,294,224	A	*	12/1966	Horwitz	.....	206/219
D263,095	S	*	2/1982	Wajs et al.	.....	D3/299
4,805,767	A	*	2/1989	Newman	.....	206/219
5,779,052	A	*	7/1998	Wooford et al.	.....	206/521

D473,775 S \* 4/2003 Moldovan ..... D3/299

\* cited by examiner

*Primary Examiner*—Paula A. Mortimer

(74) *Attorney, Agent, or Firm*—Cantor Colburn LLP

(57) **CLAIM**

The ornamental design for a package, as shown and described.

**DESCRIPTION**

FIG. 1 is a perspective view of a package, showing my new design;  
 FIG. 2 is a front elevational view thereof;  
 FIG. 3 is a rear elevational view thereof;  
 FIG. 4 is a side elevational view thereof;  
 FIG. 5 is another side elevational view thereof, taken opposite to that shown in FIG. 4;  
 FIG. 6 is a top plan view thereof;  
 FIG. 7 is a bottom plan view thereof;  
 FIG. 8 is a perspective view showing the package in an open position;  
 FIG. 9 is a front elevational view thereof;  
 FIG. 10 is a rear elevational view thereof;  
 FIG. 11 is a side elevational view thereof;  
 FIG. 12 is another side elevational view thereof; taken opposite that shown in FIG. 11;  
 FIG. 13 is a top plan view thereof; and,  
 FIG. 14 is a bottom plan view thereof.

**1 Claim, 7 Drawing Sheets**

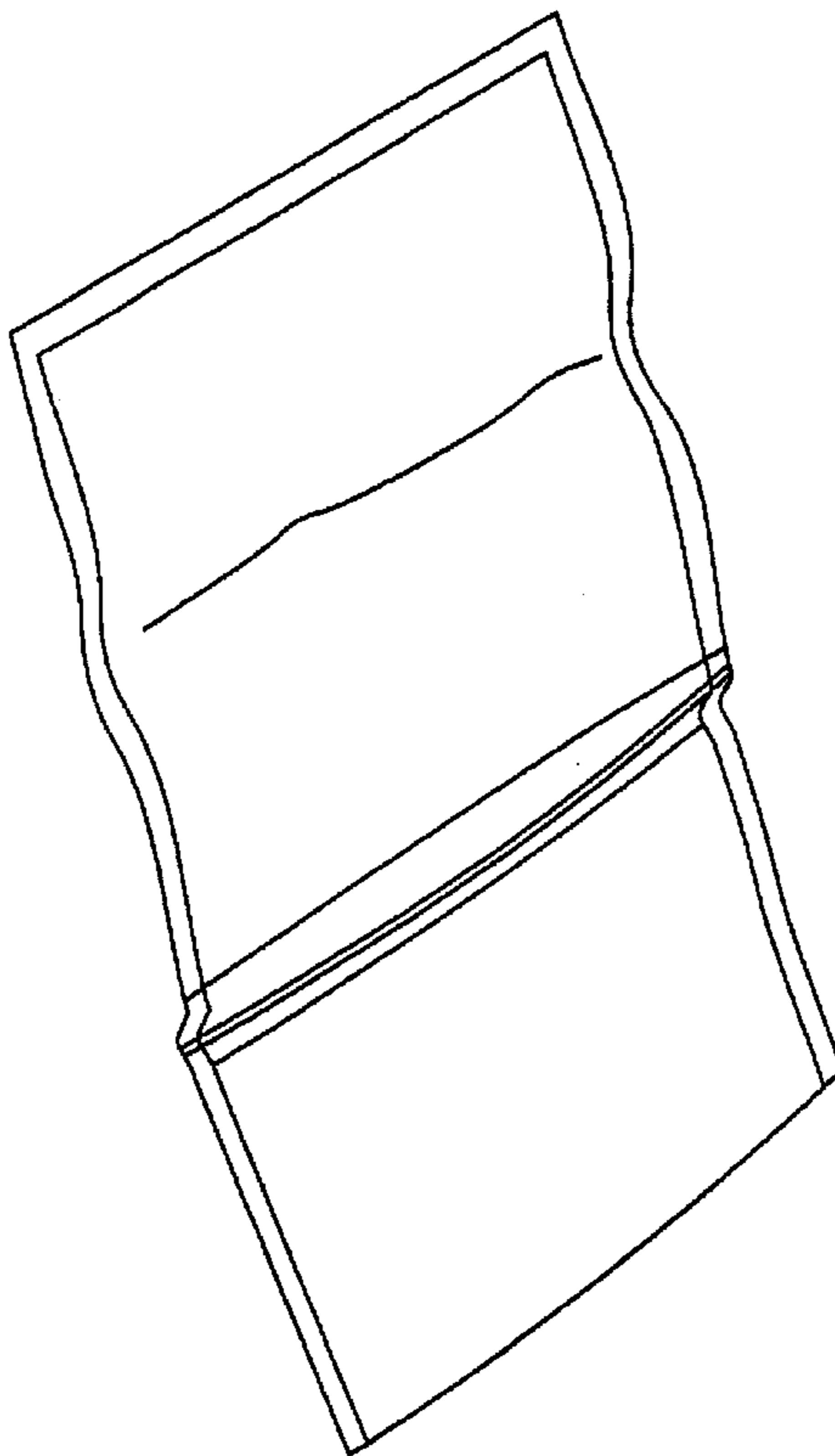

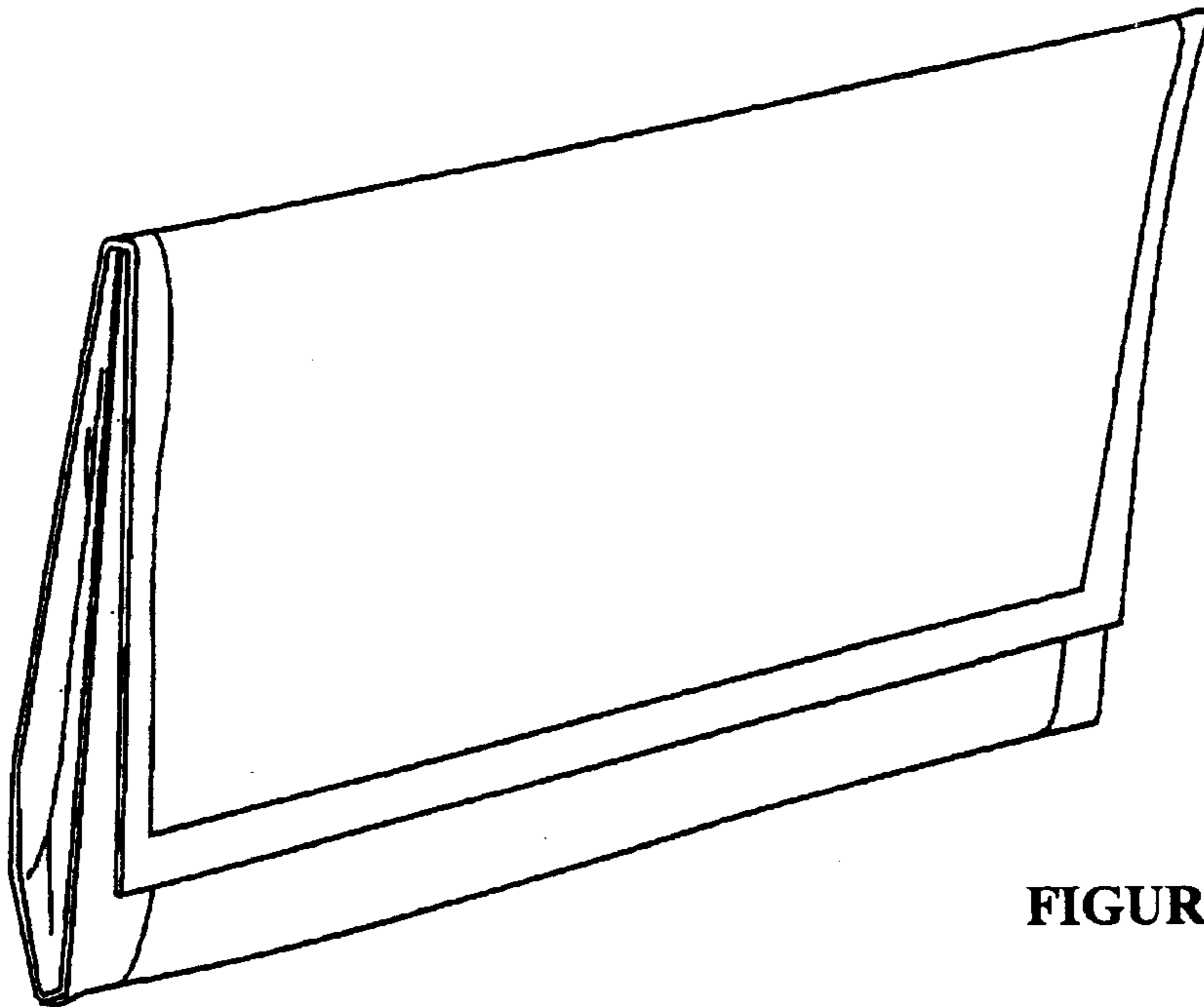

FIGURE 1

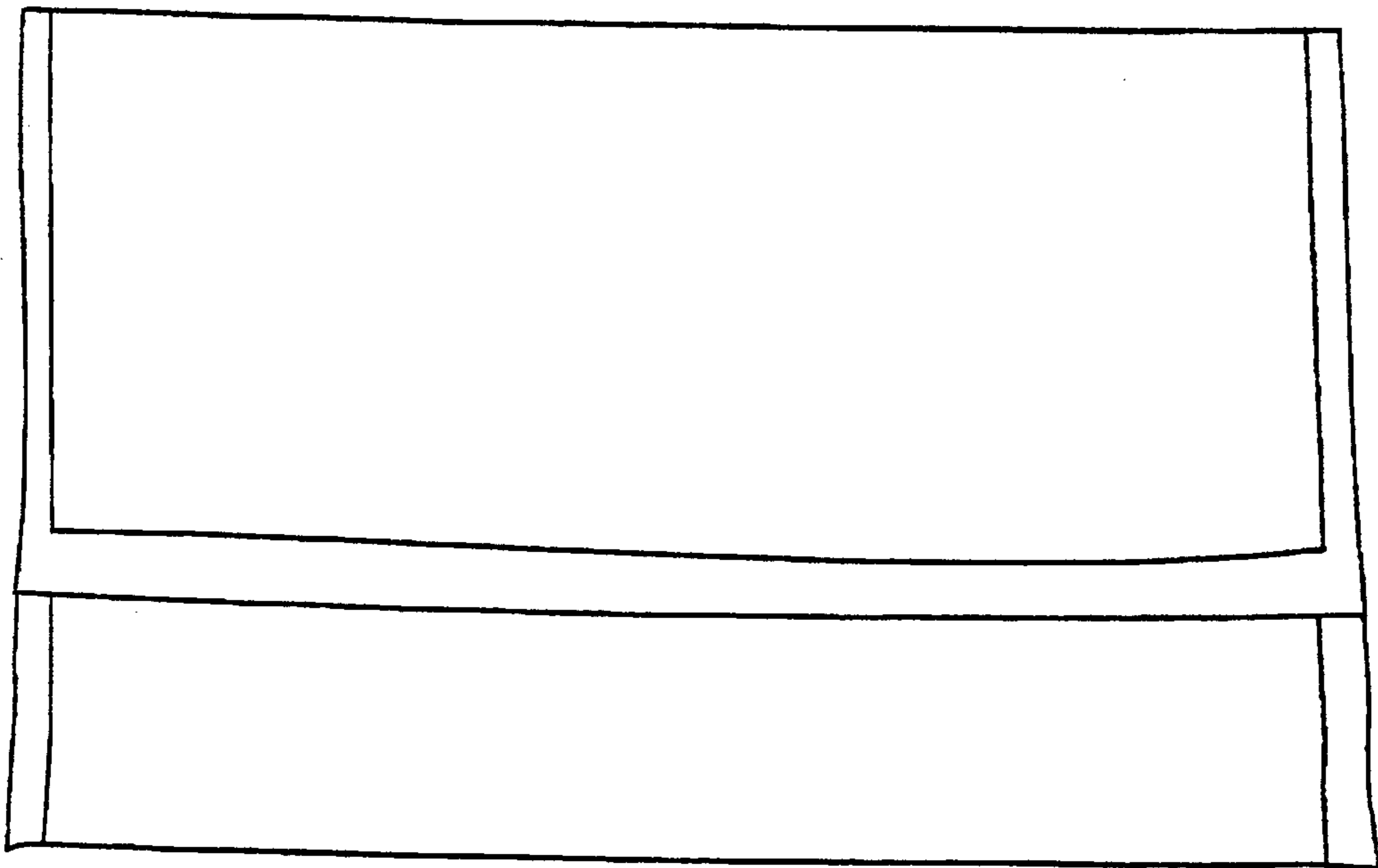
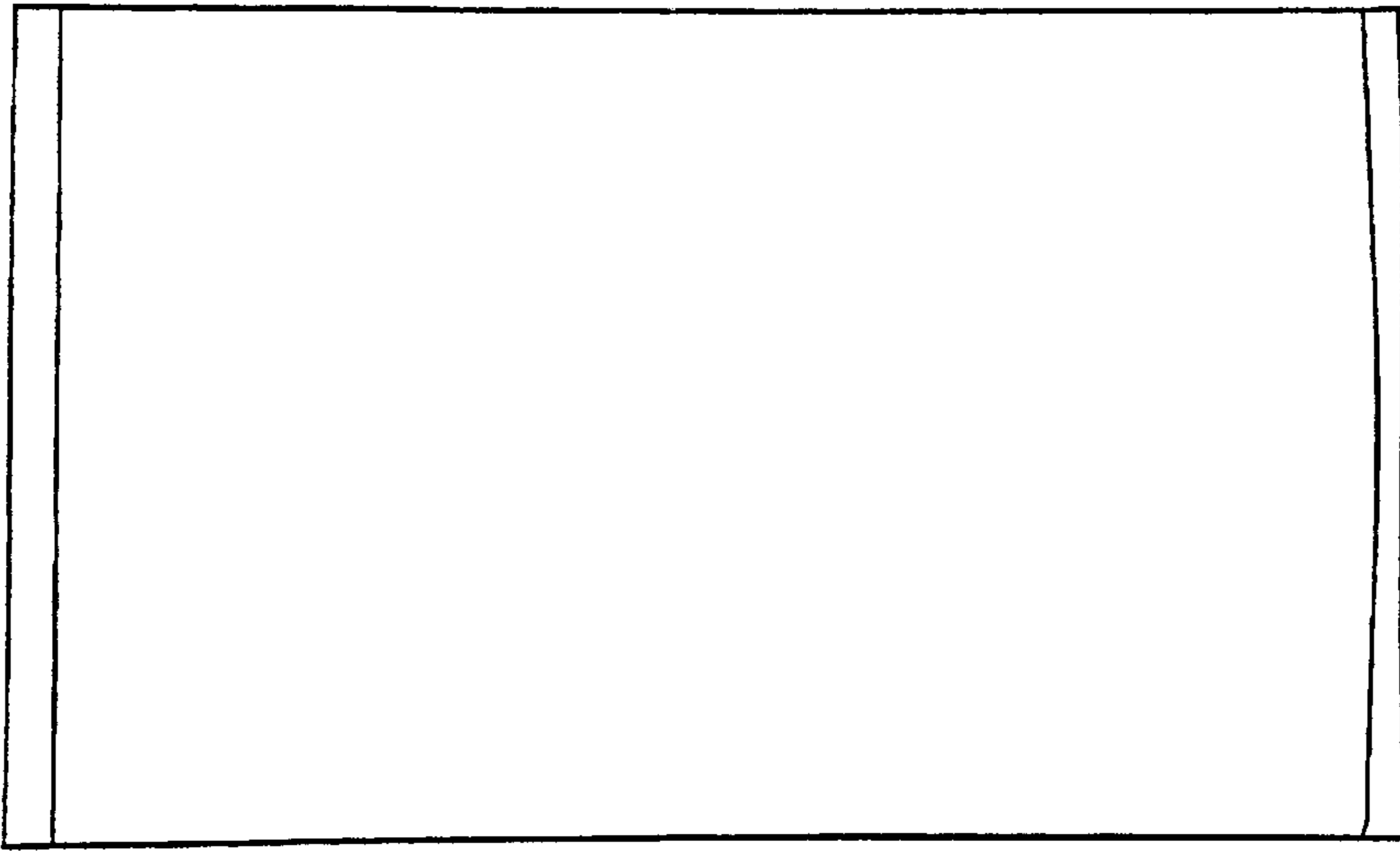
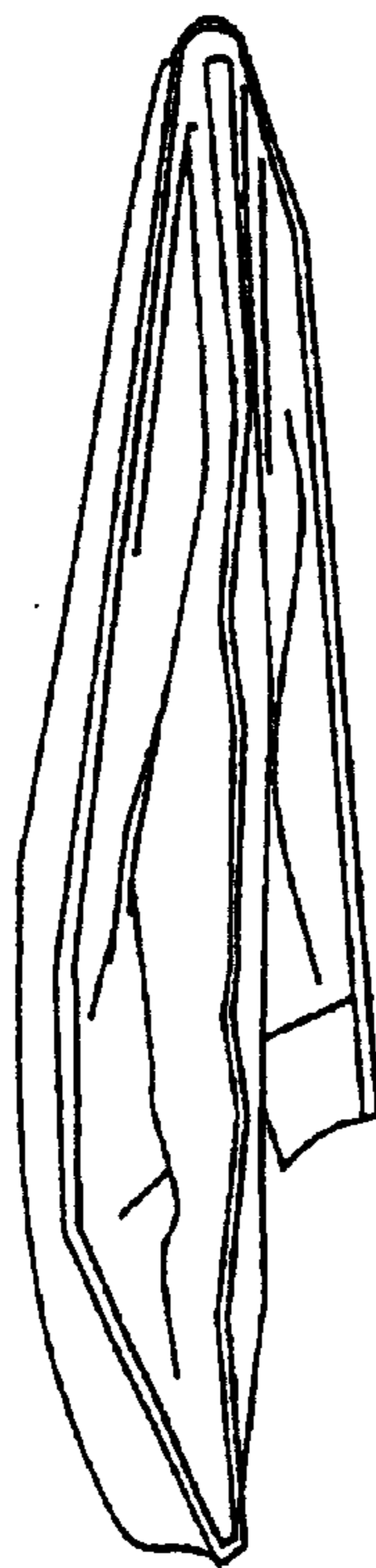

FIGURE 2



**FIGURE 3**



**FIGURE 4**



**FIGURE 5**



**FIGURE 6**

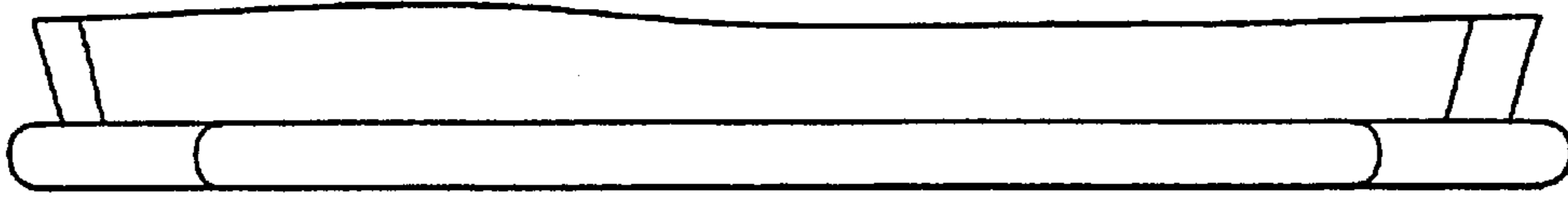

**FIGURE 7**

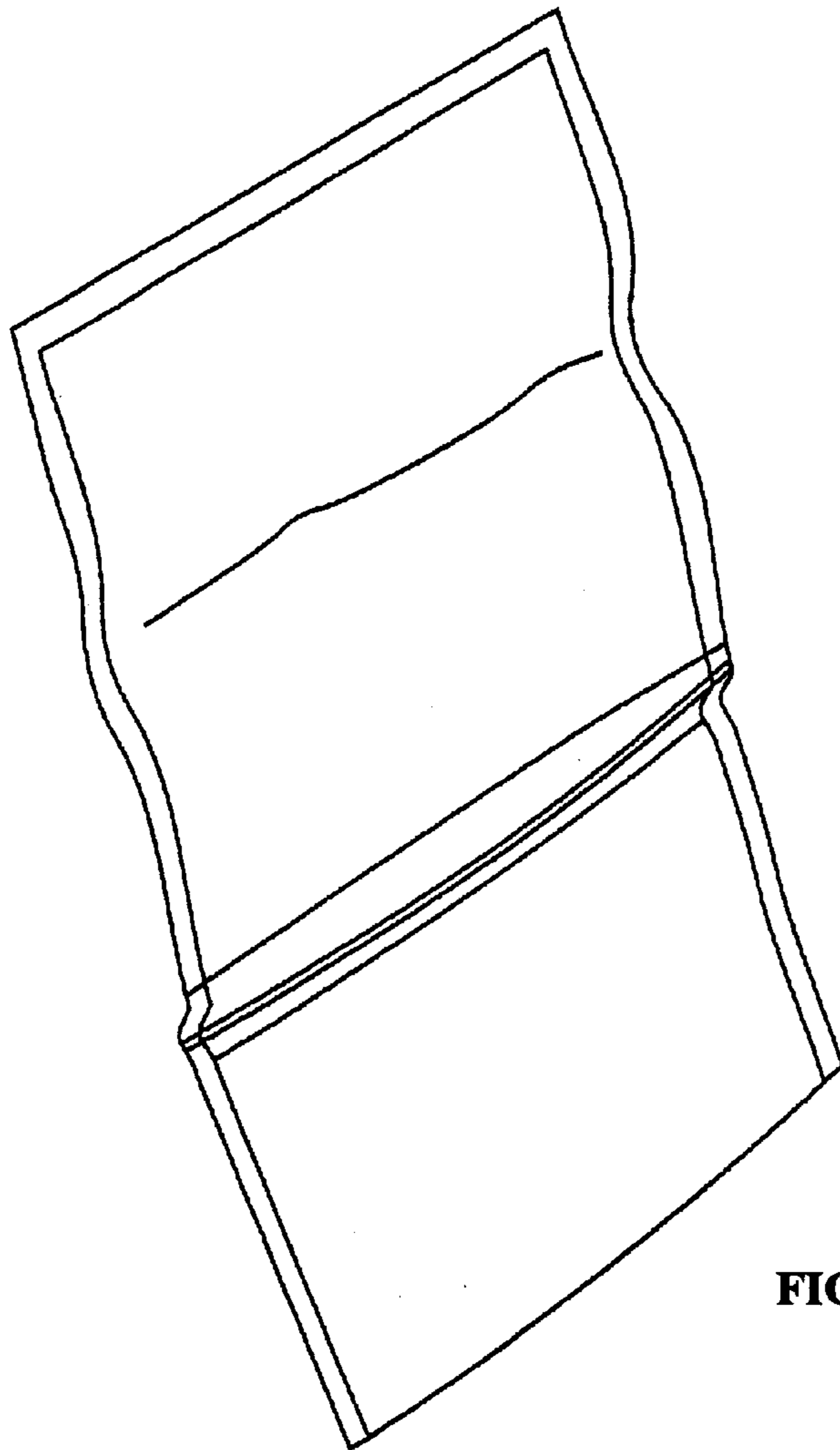

**FIGURE 8**

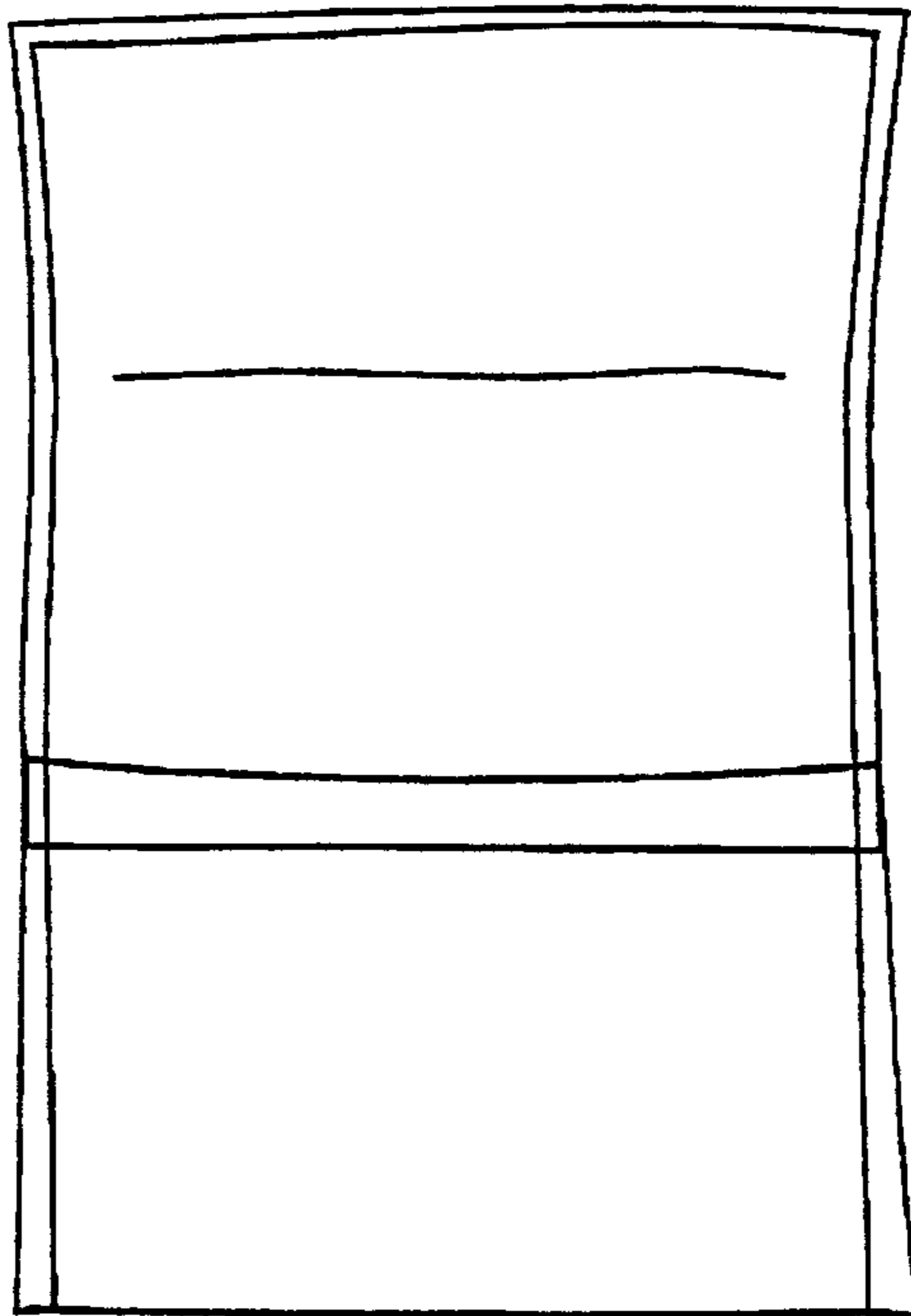

FIGURE 9

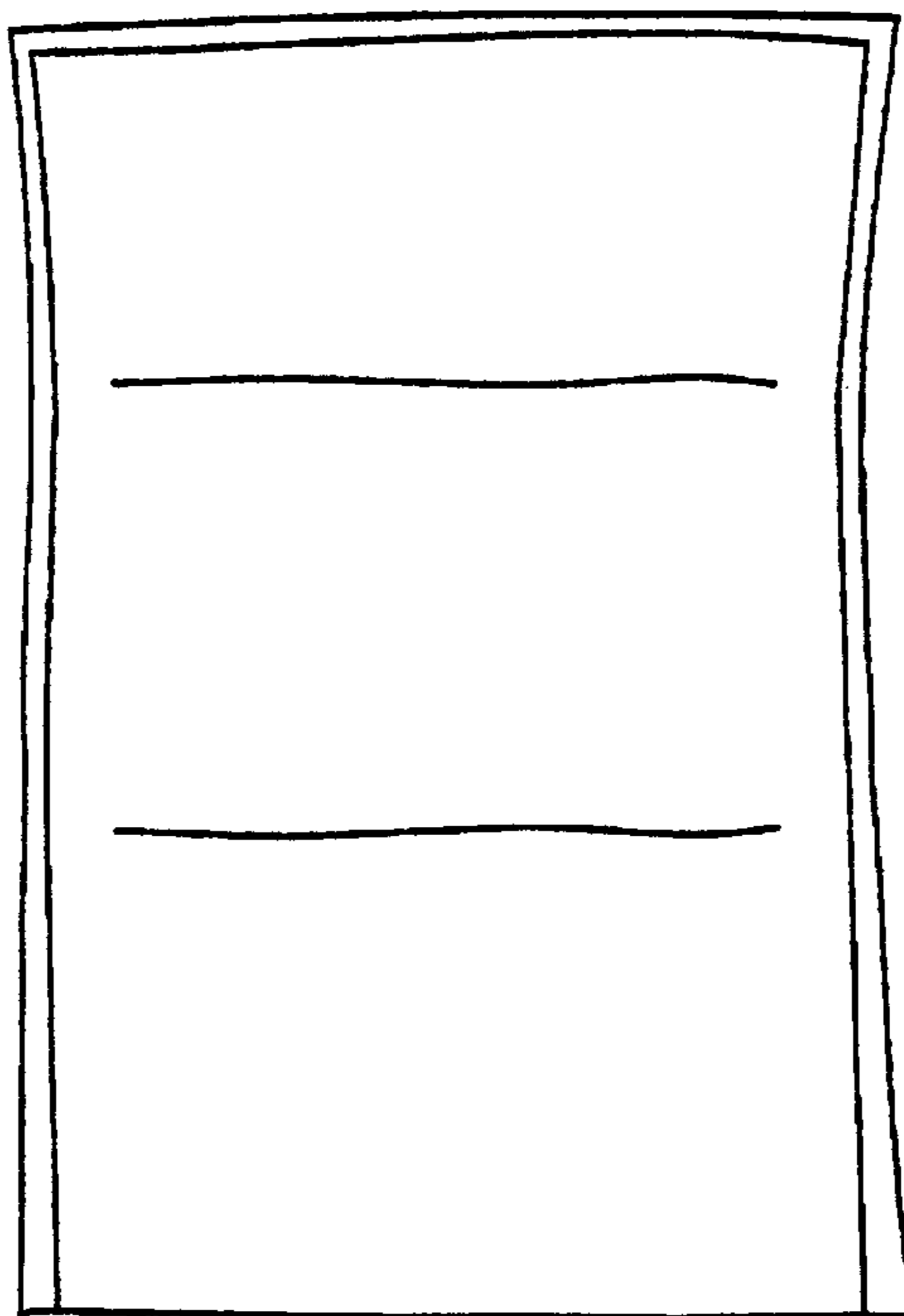

FIGURE 10



FIGURE 11



FIGURE 12

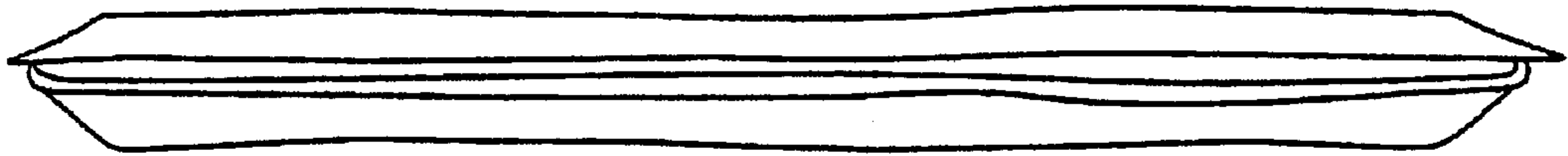

FIGURE 13



FIGURE 14