



US00D486709S

(12) **United States Design Patent**
Lin

(10) **Patent No.:** **US D486,709 S**

(45) **Date of Patent:** **** Feb. 17, 2004**

(54) **CORKPULLER**

2003/0033907 A1 * 2/2003 Lian 81/3.2

(76) Inventor: **Chia-Hsien Lin**, PO Box 82-144,
Taipei (TW)

* cited by examiner

(**) Term: **14 Years**

Primary Examiner—Caron D. Veynar
(74) *Attorney, Agent, or Firm*—Leong C. Lei

(21) Appl. No.: **29/170,864**

(57) **CLAIM**

(22) Filed: **Nov. 14, 2002**

The ornamental design for a corkpuller, as shown and described.

(51) **LOC (7) Cl.** **07-99**

DESCRIPTION

(52) **U.S. Cl.** **D8/40**

(58) **Field of Search** D8/33-43; 7/151-156;
30/400-450; 81/3.07-3.49

FIG. 1 is perspective view of a corkpuller showing my new design;
FIG. 2 is a front side elevation view thereof;
FIG. 3 is a rear side elevation view thereof;
FIG. 4 is a left side elevation view thereof;
FIG. 5 is a right side elevation view thereof;
FIG. 6 is a top plan view thereof;
FIG. 7 is a bottom plan view thereof; and,
FIG. 8 is a perspective view of the corkpuller in an extended position.

(56) **References Cited**

U.S. PATENT DOCUMENTS

2,718,801	A	*	9/1955	Finley	81/3.41
4,374,464	A	*	2/1983	Tillander	53/324
D268,245	S	*	3/1983	Makino et al.	D8/42
D288,521	S	*	3/1987	Van Asten	D8/42
4,697,480	A	*	10/1987	Robideau	81/3.09
6,502,481	B1	*	1/2003	Lin	81/3.2
2002/0083797	A1	*	7/2002	Federighi	81/3.2

1 Claim, 8 Drawing Sheets

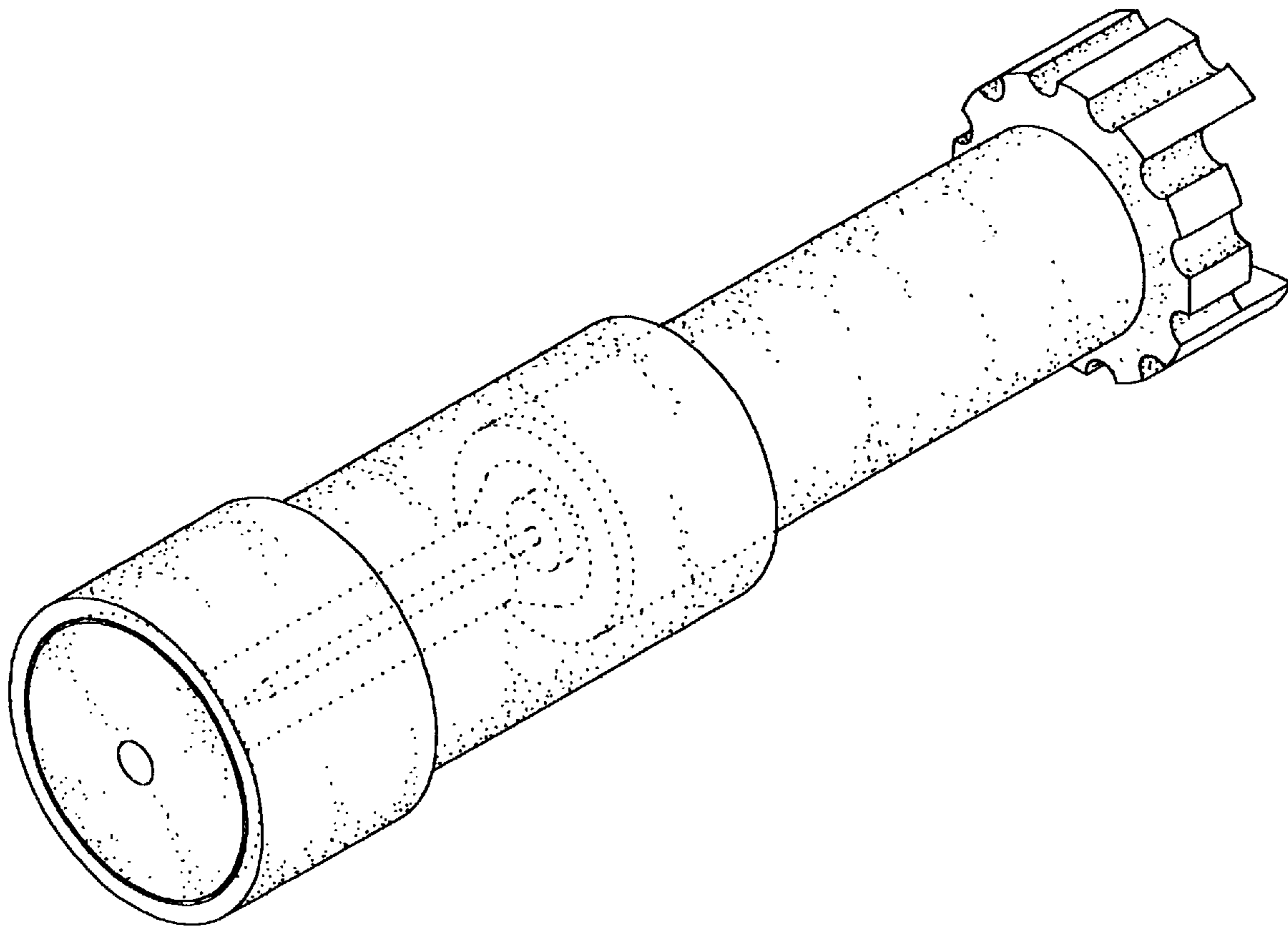

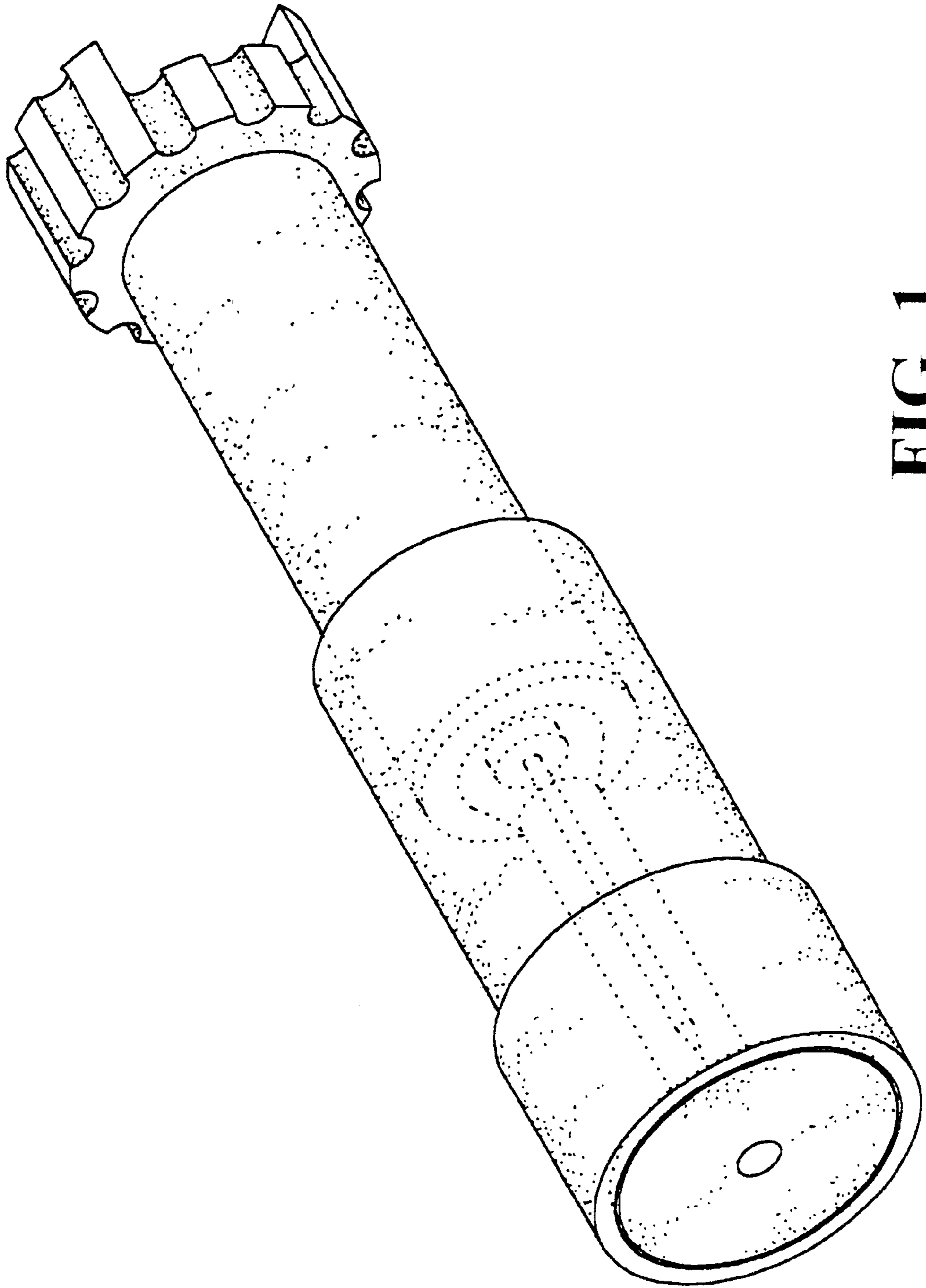

FIG. 1

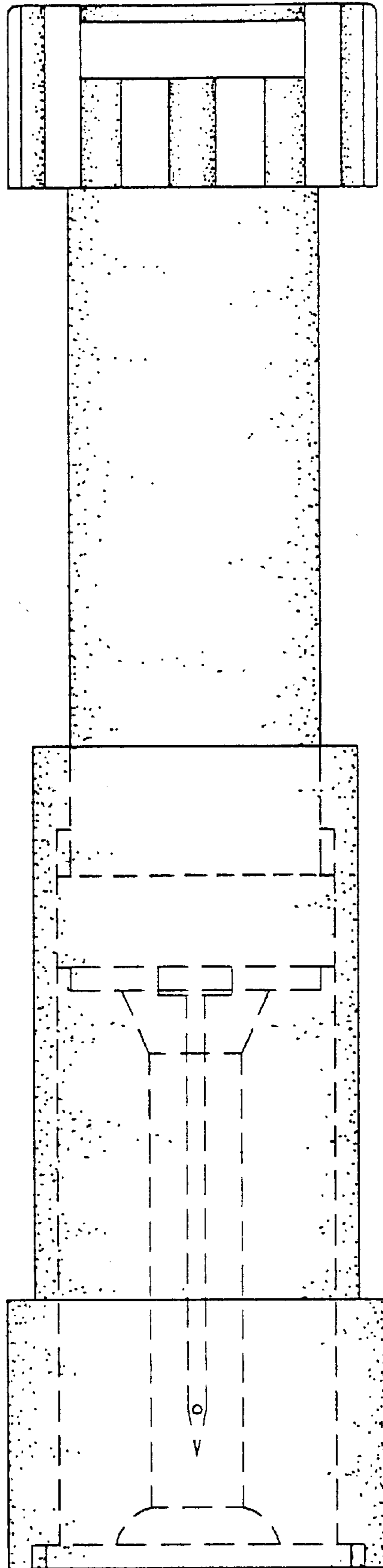

FIG. 2

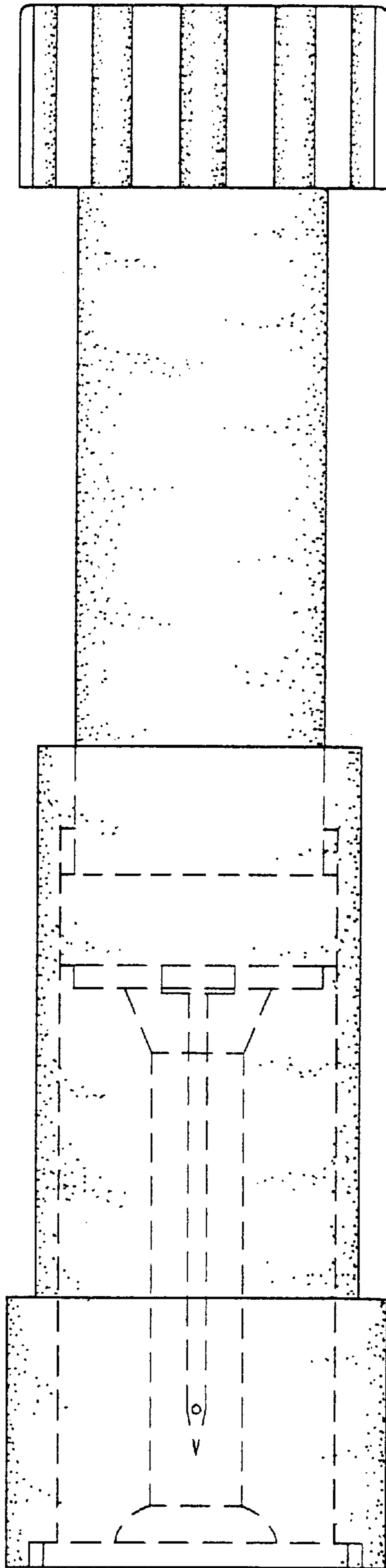

FIG. 3

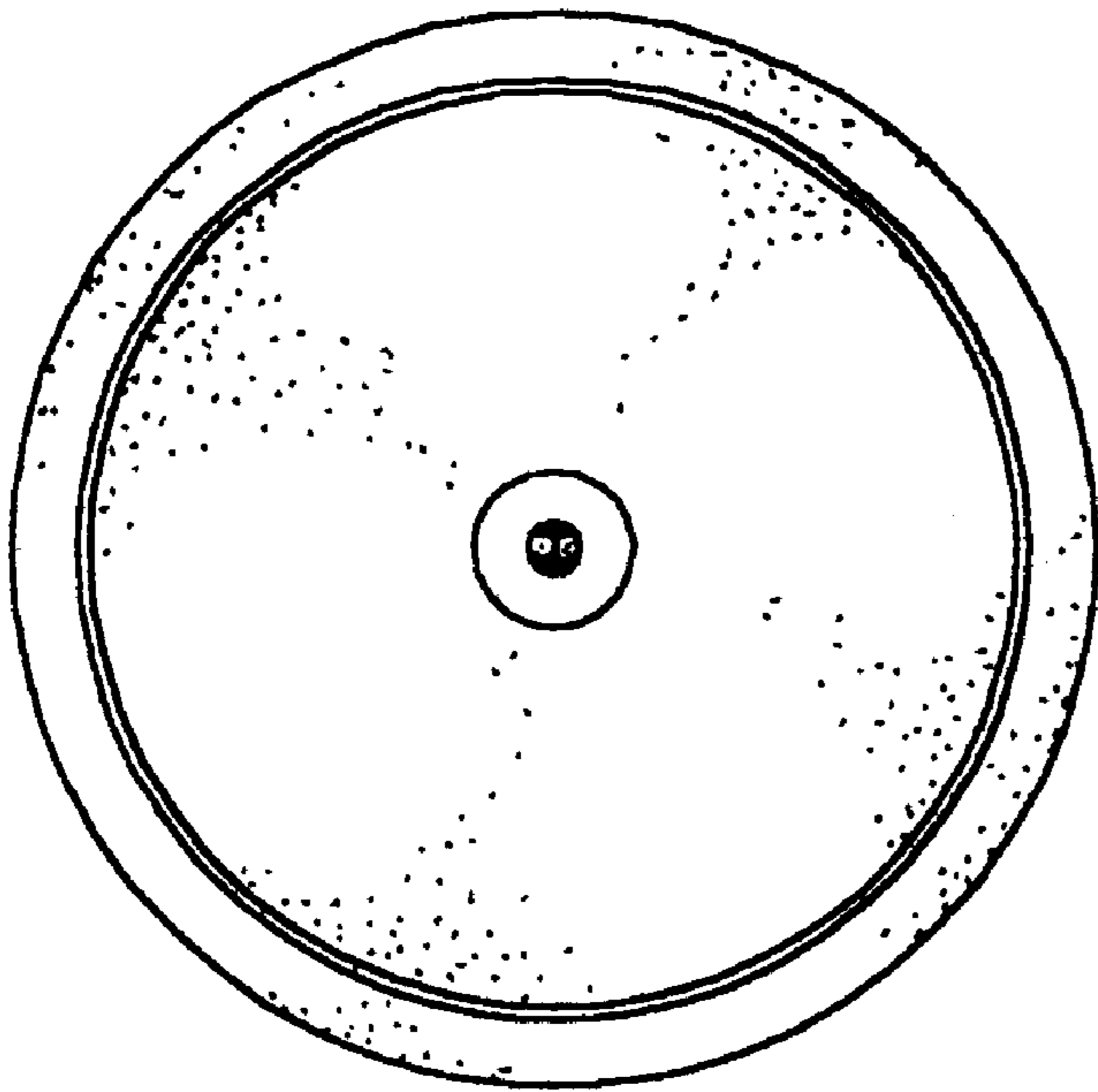

FIG. 4

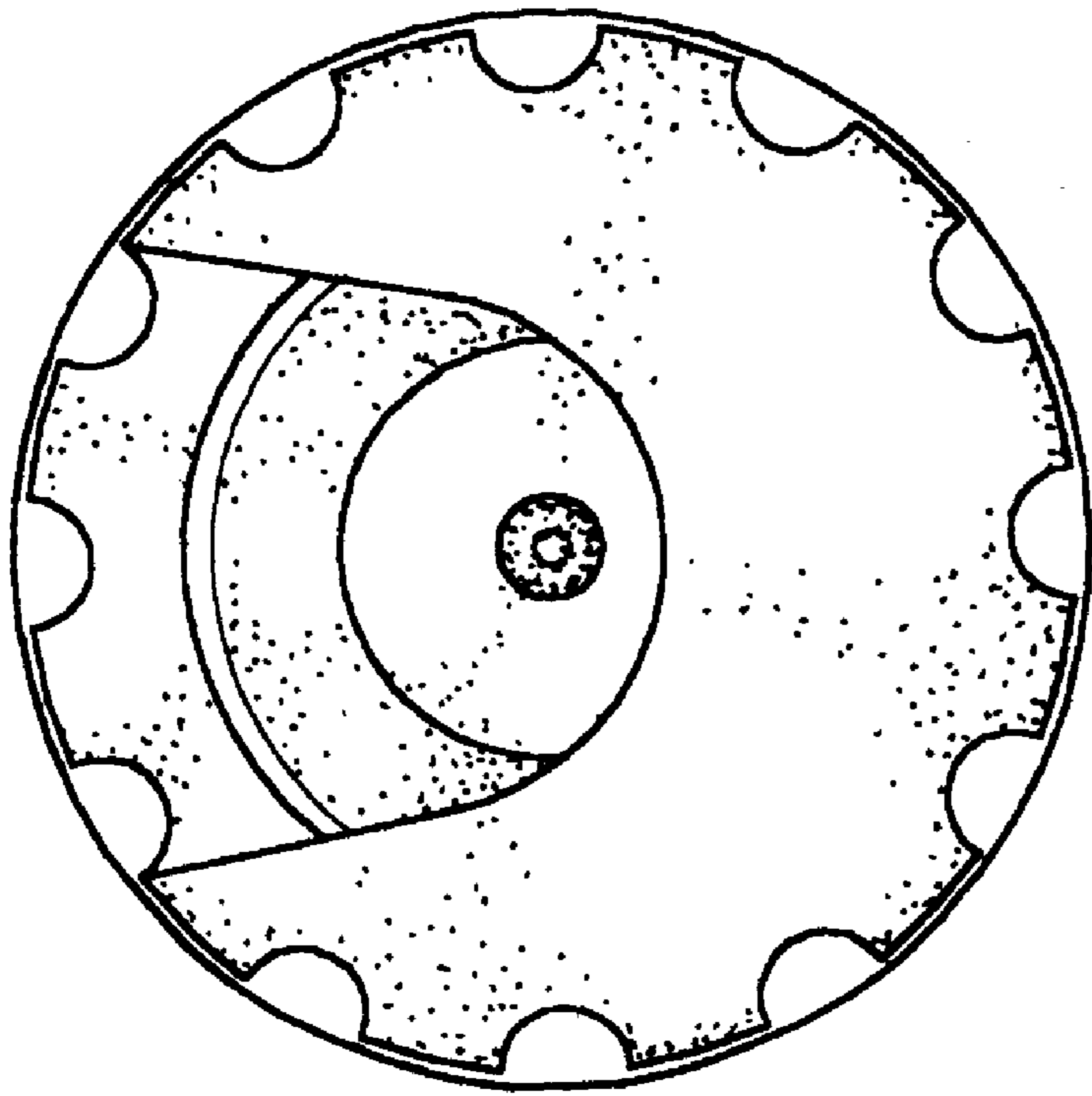

FIG. 5

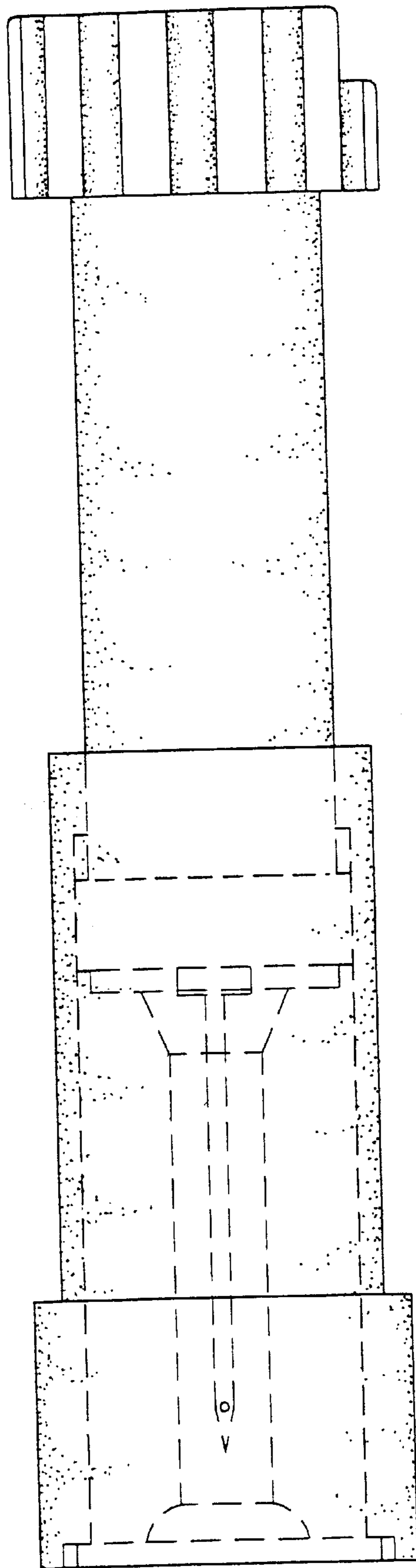

FIG. 6

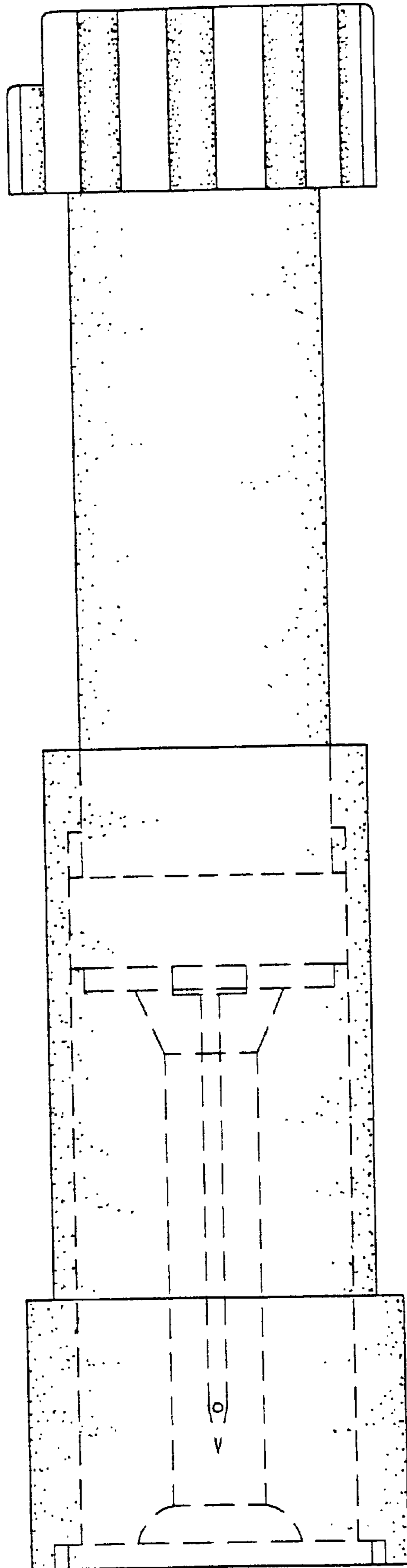

FIG. 7

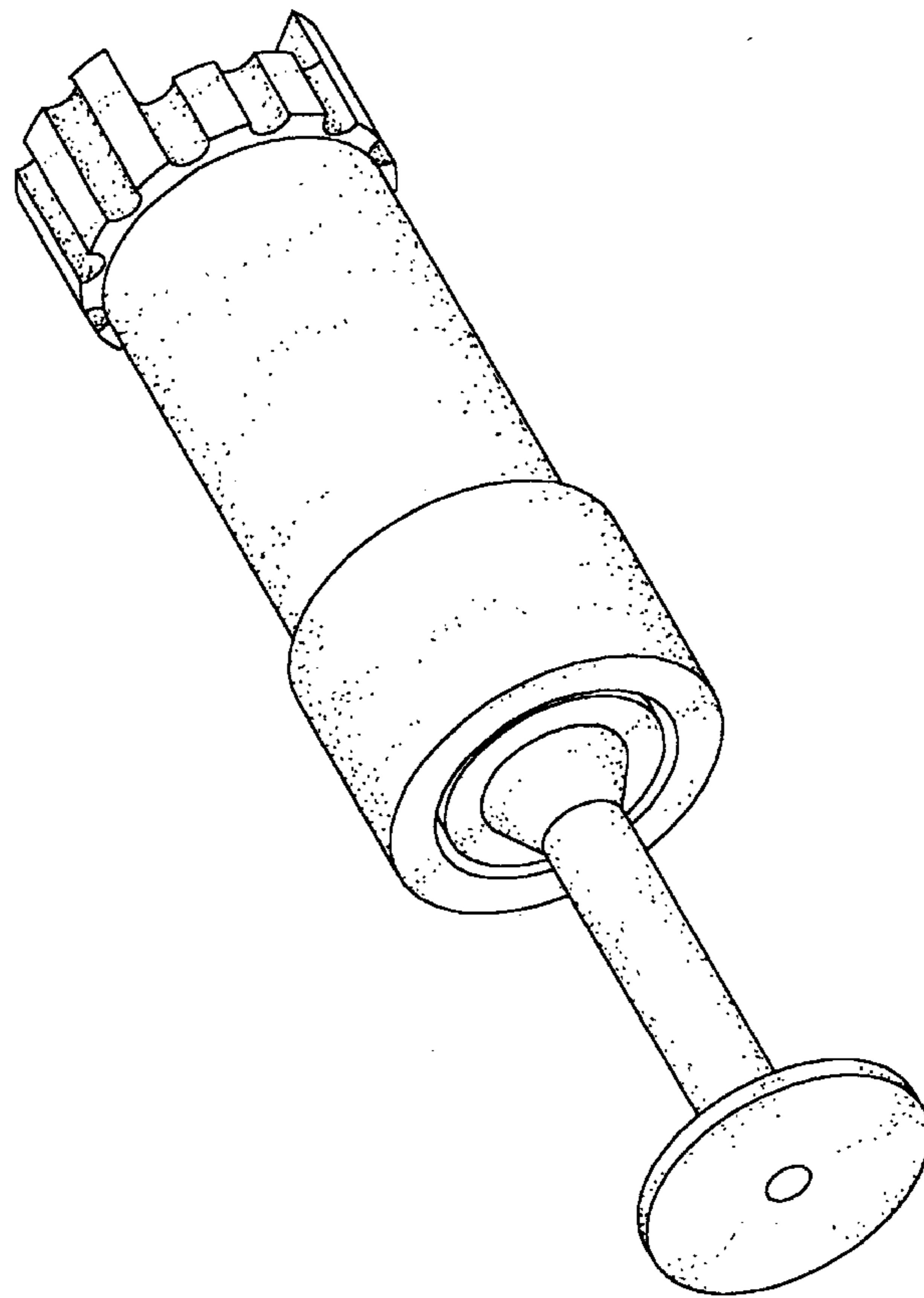

FIG. 8