



US00D486687S

(12) **United States Design Patent**
Strandell

(10) **Patent No.:** **US D486,687 S**

(45) **Date of Patent:** **** Feb. 17, 2004**

(54) **ICE DISPENSER AND ICE/BEVERAGE DISPENSER**

(75) Inventor: **Timothy B. Strandell**, Racine, WI (US)

(73) Assignee: **Manitowoc Foodservice Companies, Inc.**, Manitowoc, WI (US)

(**) Term: **14 Years**

(21) Appl. No.: **29/157,218**

(22) Filed: **Mar. 14, 2002**

(51) **LOC (7) Cl.** **07-01**

(52) **U.S. Cl.** **D7/307; D7/308**

(58) **Field of Search** D7/300, 305, 306, D7/307, 308, 311; 222/129.1, 129.2, 129.3, 129.4, 156, 131, 146.6; 141/1, 129, 174

(56) **References Cited**

U.S. PATENT DOCUMENTS

D281,568 S	*	12/1985	Bruffey, Jr. et al.	D7/308
4,590,975 A	*	5/1986	Credle, Jr.	141/1
D284,159 S	*	6/1986	Crosby et al.	D7/311
4,951,719 A	*	8/1990	Wiley et al.	141/1
D312,021 S	*	11/1990	Mohat	D7/308
D333,405 S	*	2/1993	Moyer, Jr. et al.	D7/308
D335,062 S	*	4/1993	Kolada et al.	D7/308
D346,088 S	*	4/1994	Schroeder	D7/307
D365,960 S	*	1/1996	Barish	D7/308
D365,962 S	*	1/1996	Amundsen et al.	D7/311
D367,585 S	*	3/1996	Piatnik et al.	D7/397
D368,617 S	*	4/1996	Jackson et al.	D7/306
D390,058 S	*	2/1998	Landers	D7/307
D442,417 S	*	5/2001	Jones et al.	D7/307
D452,406 S		12/2001	Schroeder et al.		
D461,675 S	*	8/2002	Kemper et al.	D7/307
D463,945 S	*	10/2002	Sandor et al.	D7/307
D465,119 S	*	11/2002	Strandell et al.	D7/307
D467,764 S	*	12/2002	Harrison et al.	D7/306

* cited by examiner

Primary Examiner—M. N. Pandozzi

(74) *Attorney, Agent, or Firm*—Brinks Hofer Gilson & Lione

(57) **CLAIM**

The ornamental design for an ice dispenser and ice/beverage dispenser, as shown.

DESCRIPTION

FIG. 1 is a perspective view of a first embodiment of an ice/beverage dispenser showing my design.

FIG. 2 is a left-side elevational view of the embodiment of FIG. 1;

FIG. 3 is a front elevational view of the embodiment of FIG. 1;

FIG. 4 is a right-side elevational view, showing the side opposite that in FIG. 2;

FIG. 5 is a rear elevational view, showing the side opposite that in FIG. 3;

FIG. 6 is a top plan view of the embodiment of FIG. 1;

FIG. 7 is a bottom plan view of the embodiment of FIG. 1;

FIG. 8 is a front perspective view of a second embodiment of the ice/beverage dispenser.

FIG. 9 is a left-side elevational view of the embodiment of FIG. 8;

FIG. 10 is a front elevational view of the embodiment of FIG. 8;

FIG. 10 is a front elevational view of the embodiment of FIG. 8;

FIG. 11 is right-side elevational view showing the side opposite that in FIG. 9;

FIG. 12 is a rear elevational view showing the side opposite that in FIG. 10; and

FIG. 13 is a top plan view of the embodiment of FIG. 8; and,

FIG. 14 is a bottom plan view of the embodiment of FIG. 8.

1 Claim, 8 Drawing Sheets

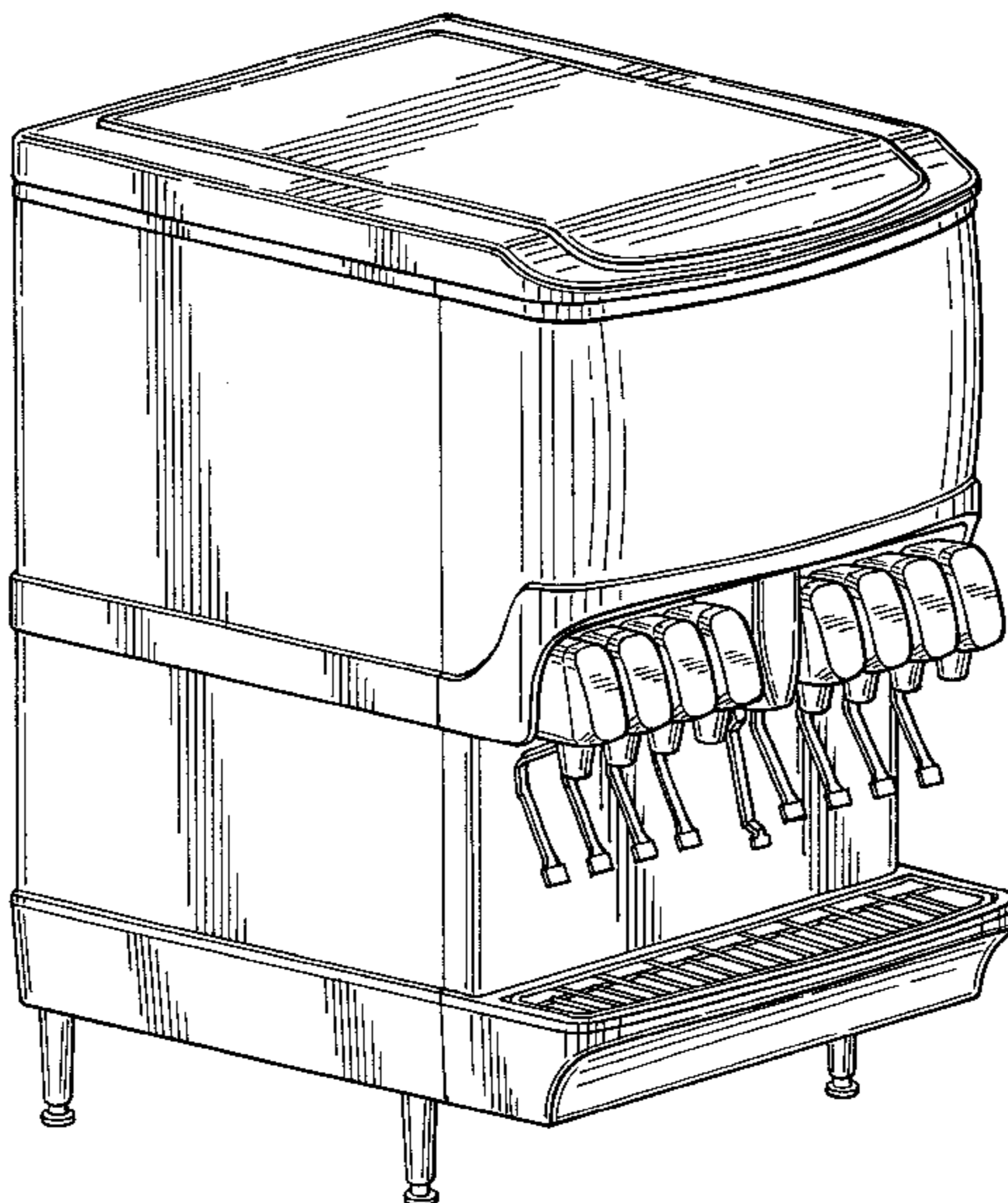

FIG. 1

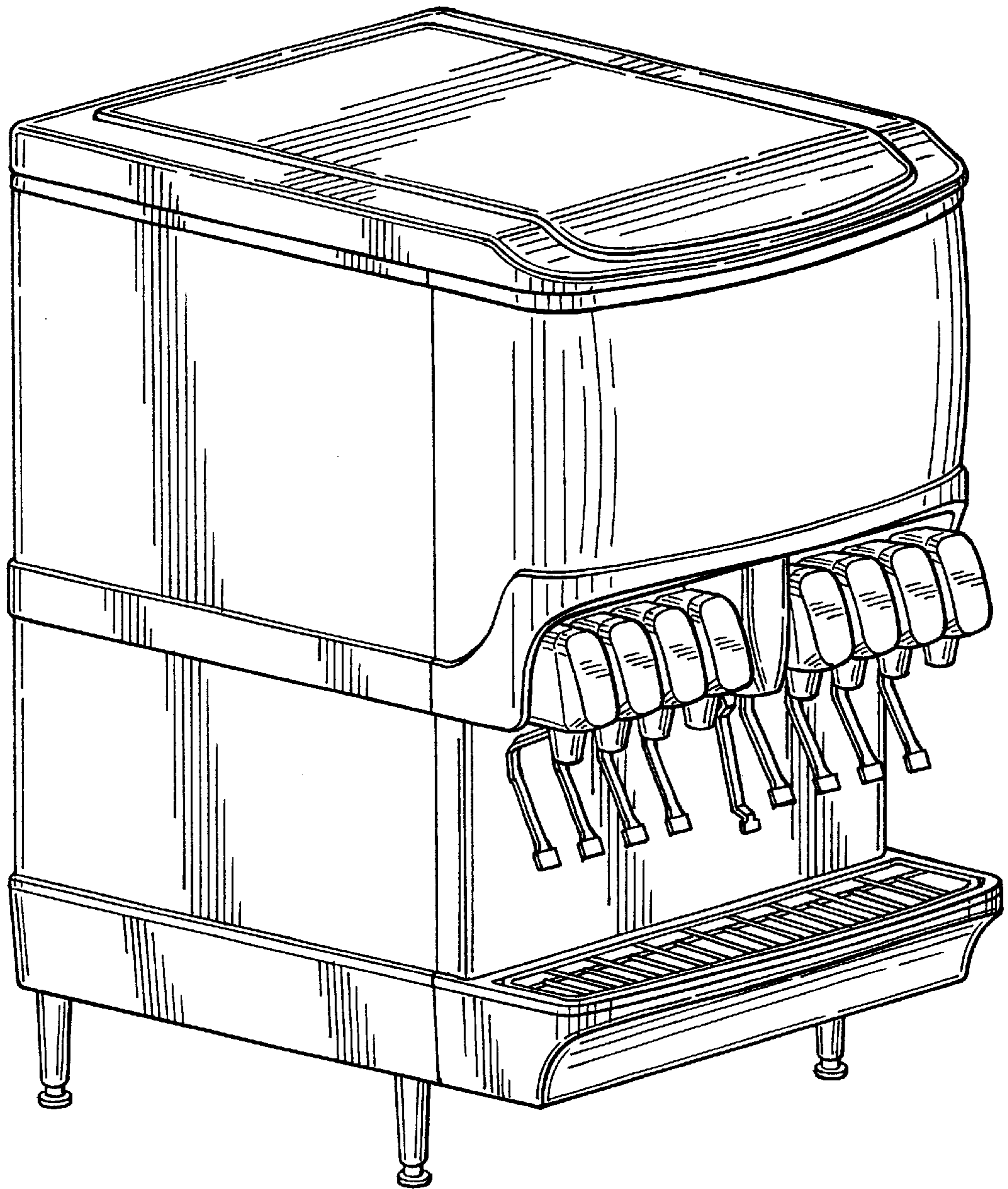

FIG. 3

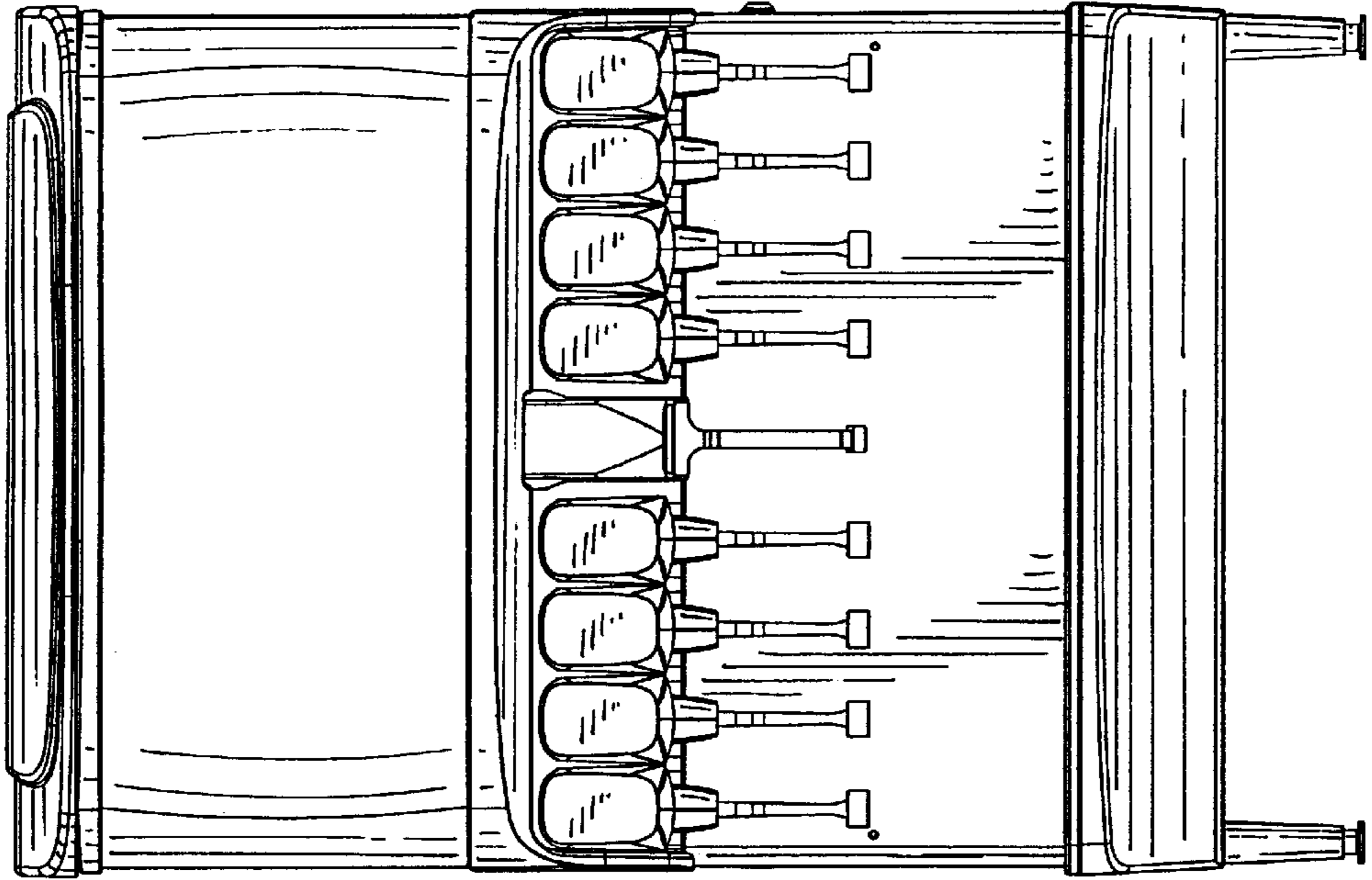

FIG. 2

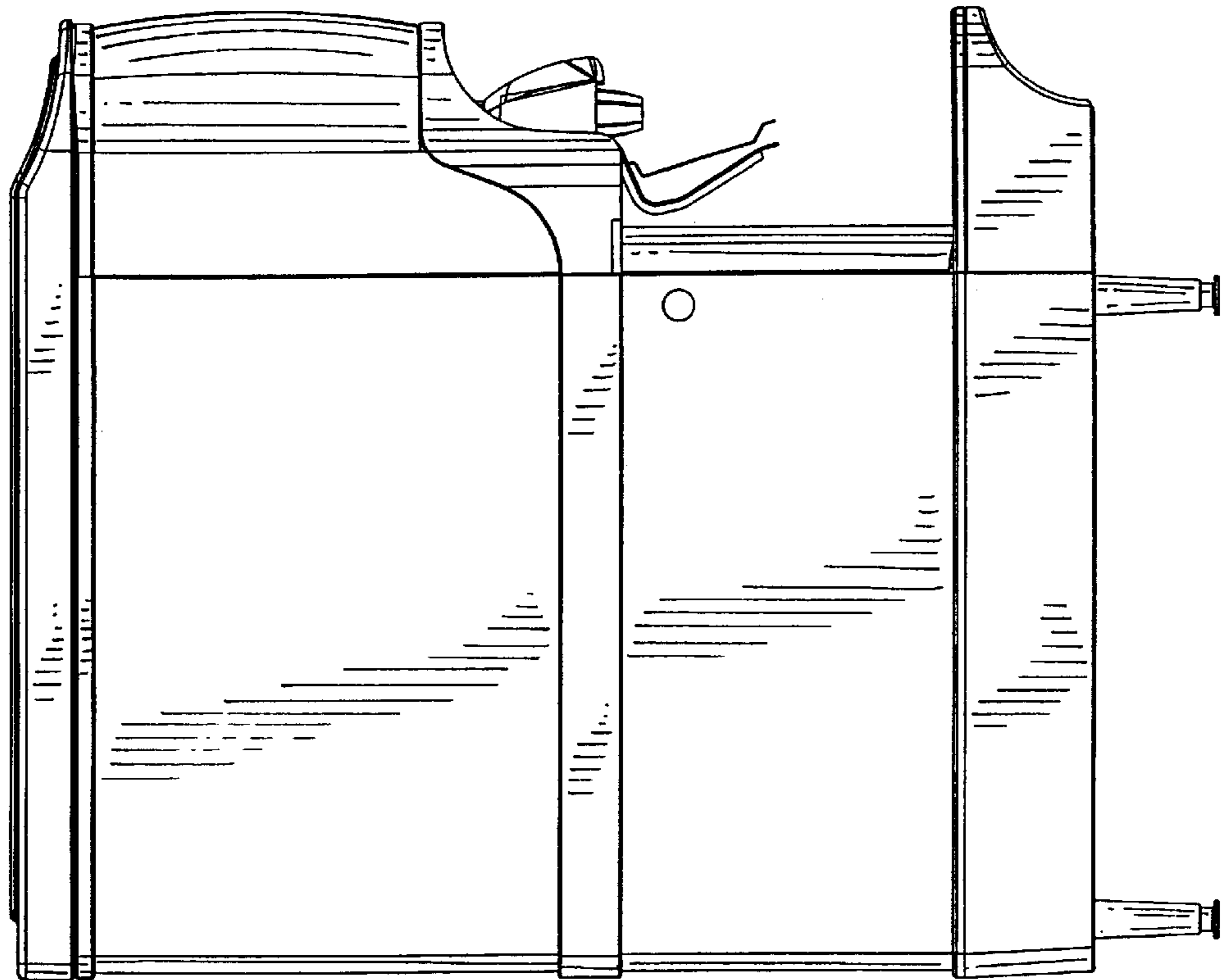

FIG. 5

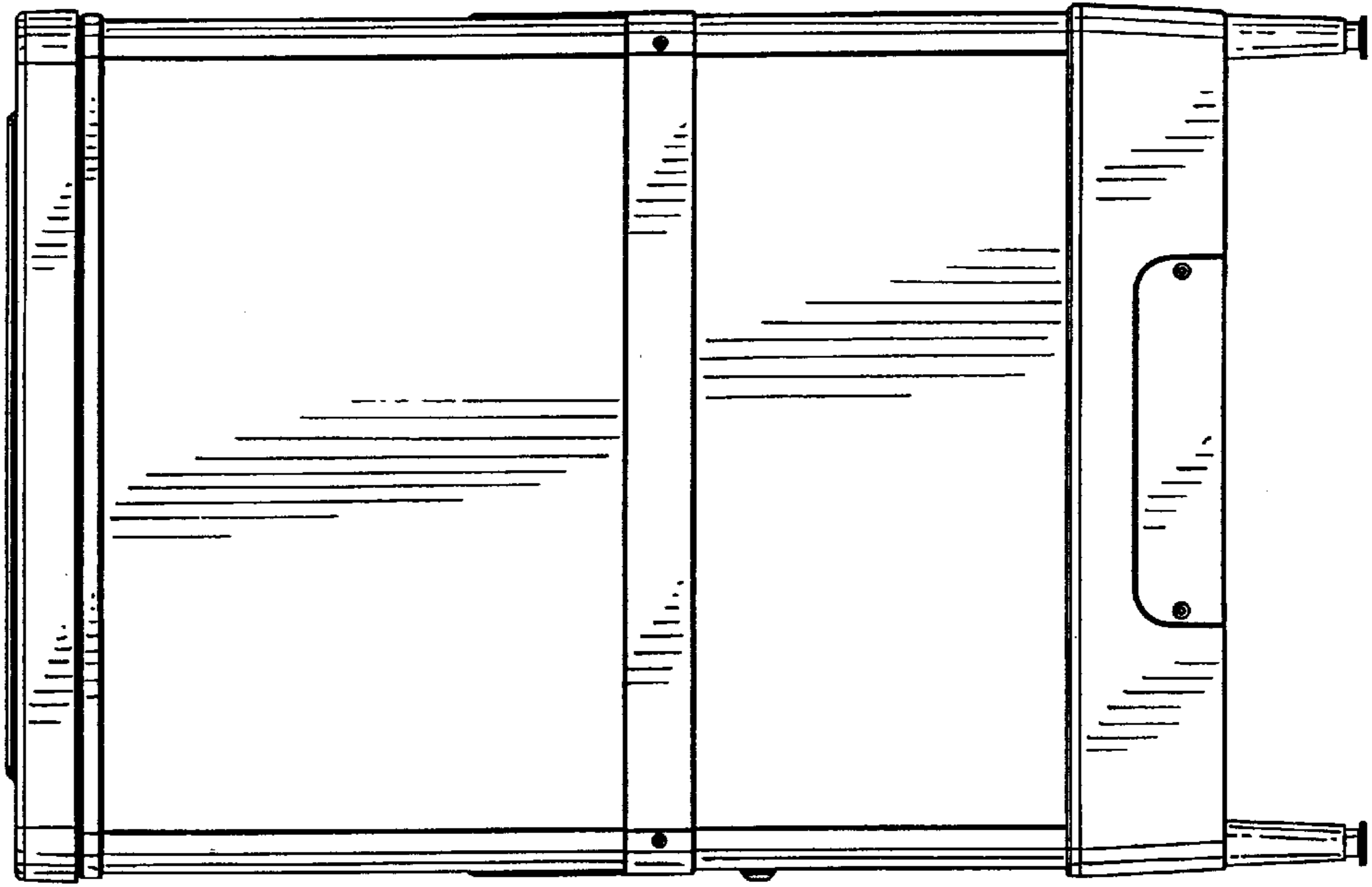

FIG. 4

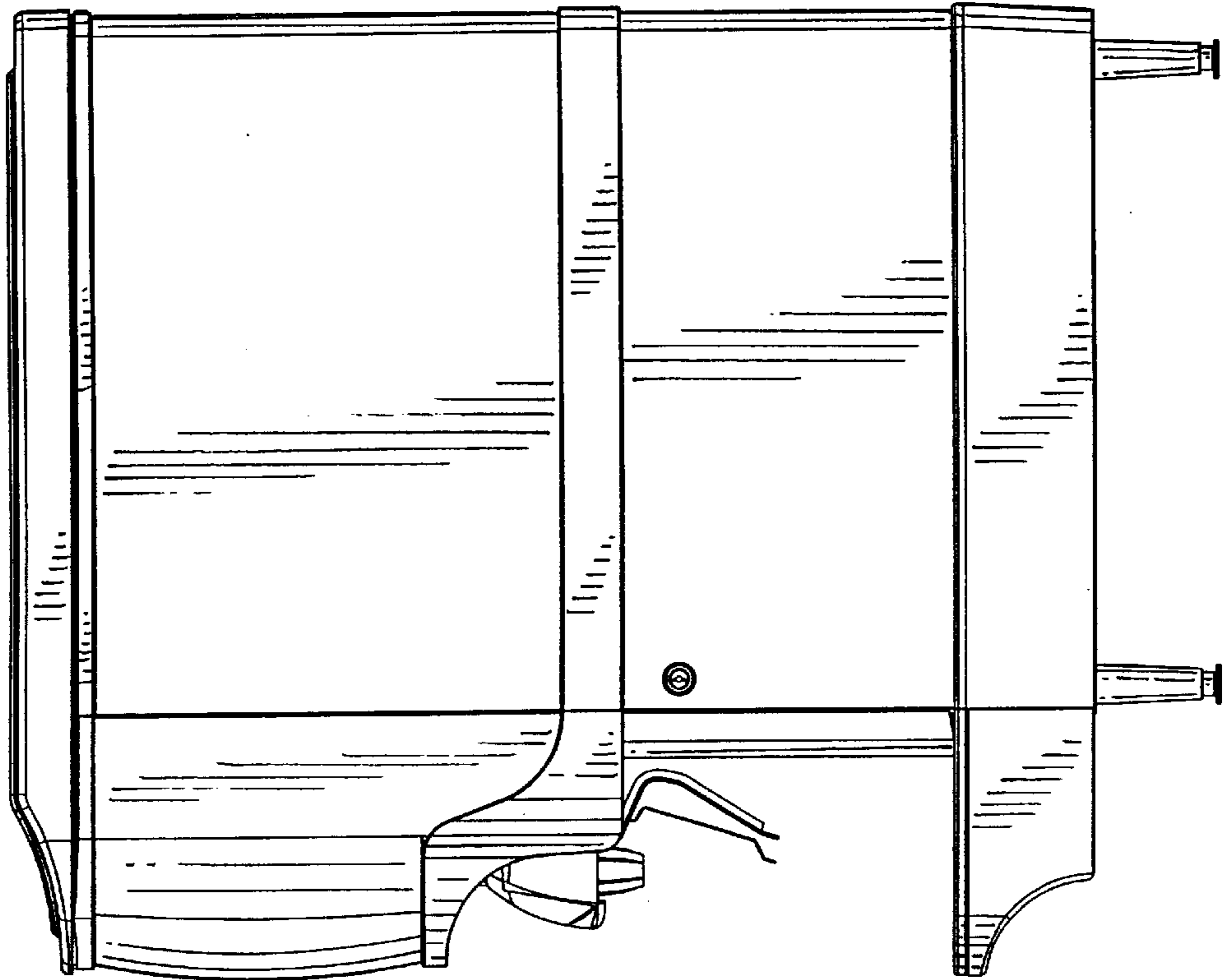

FIG. 6

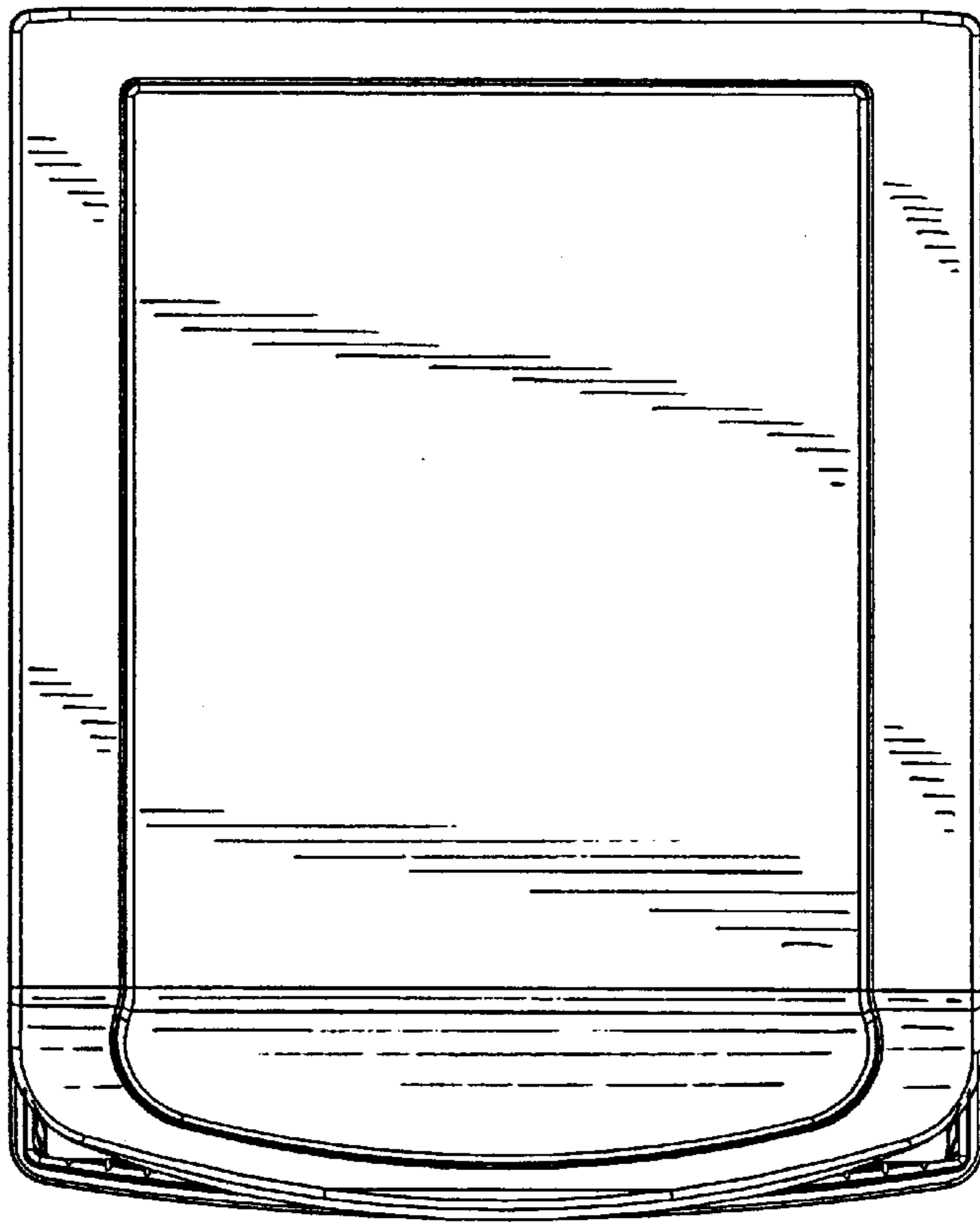

FIG. 7

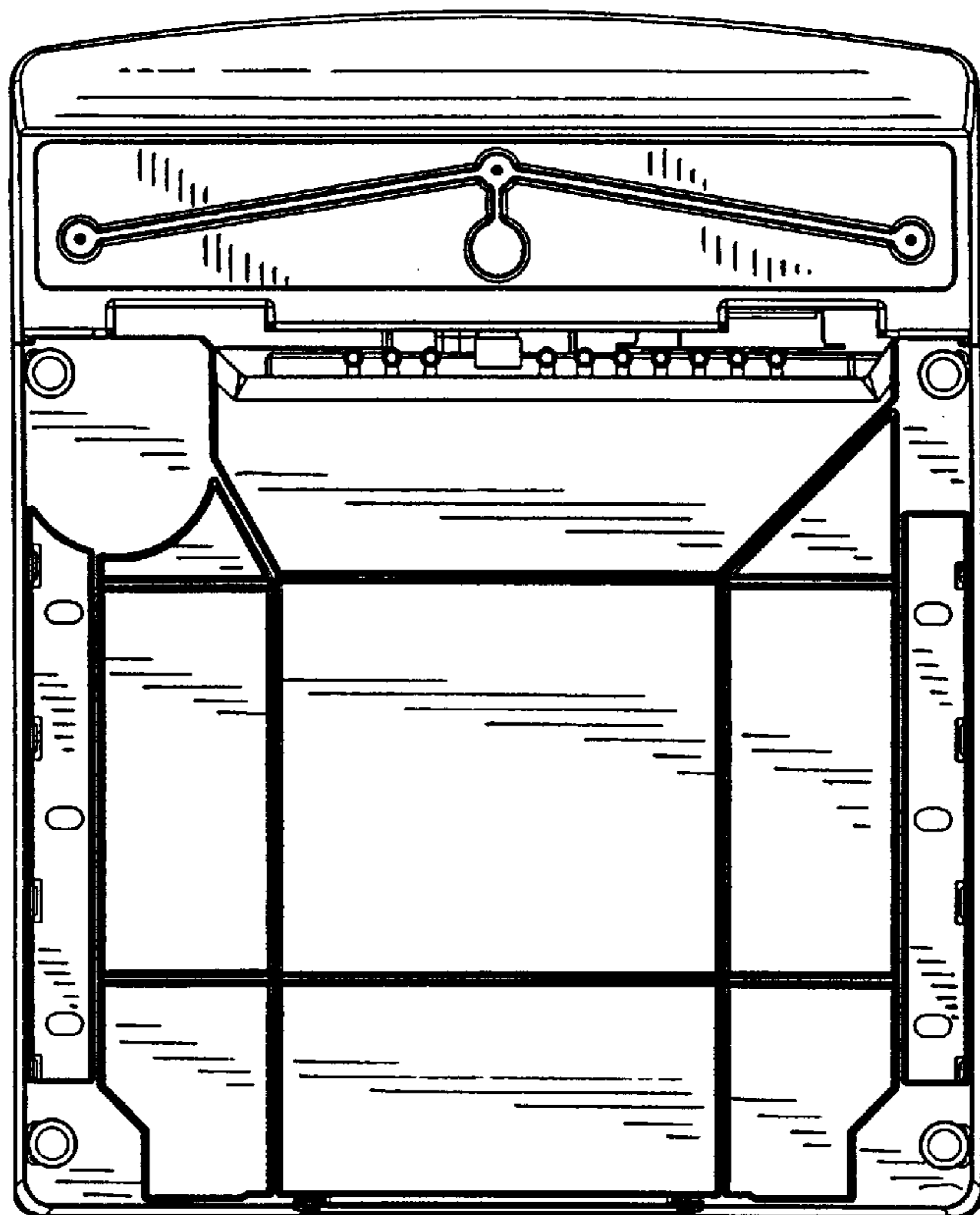

FIG. 8

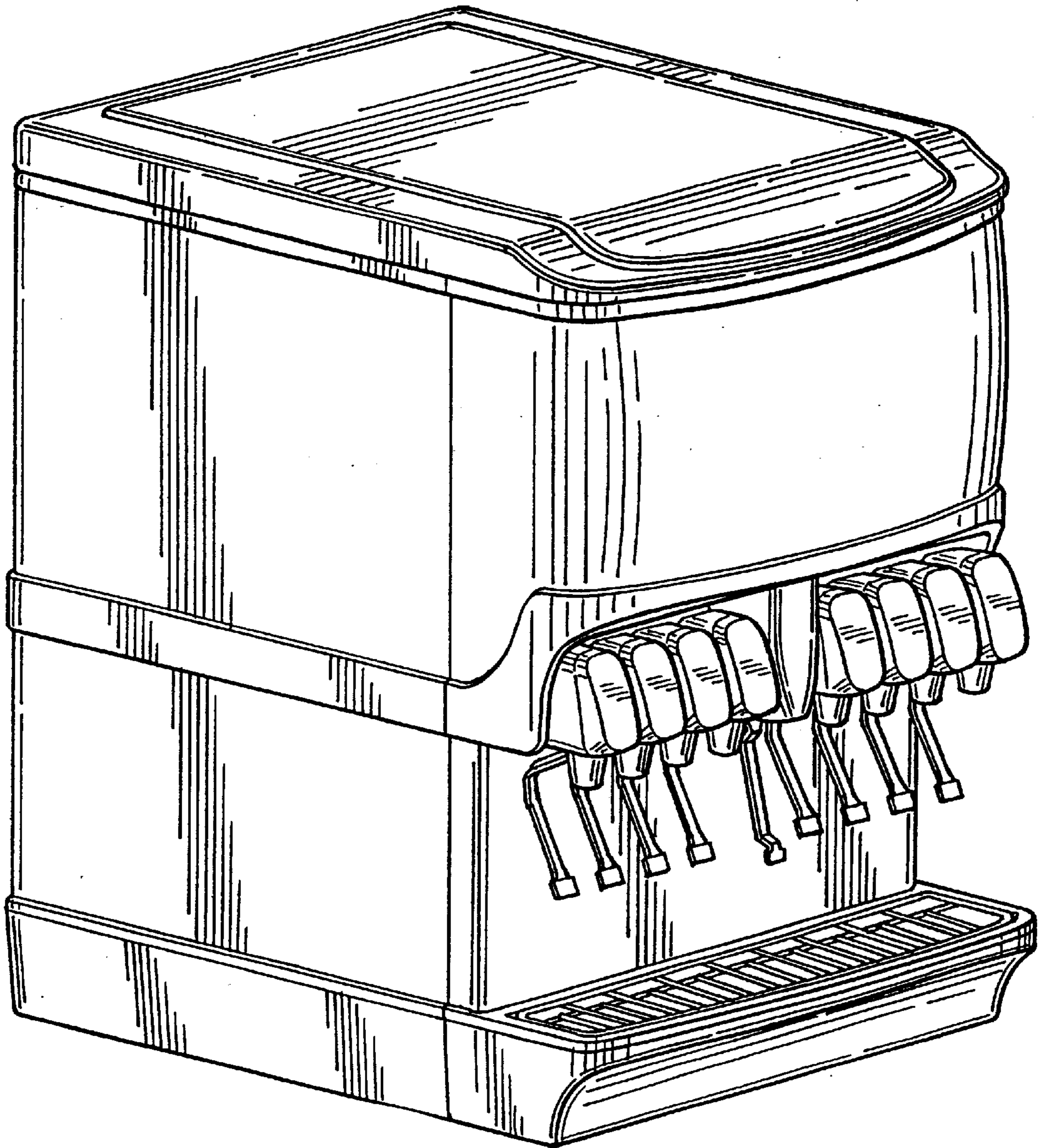

FIG. 10

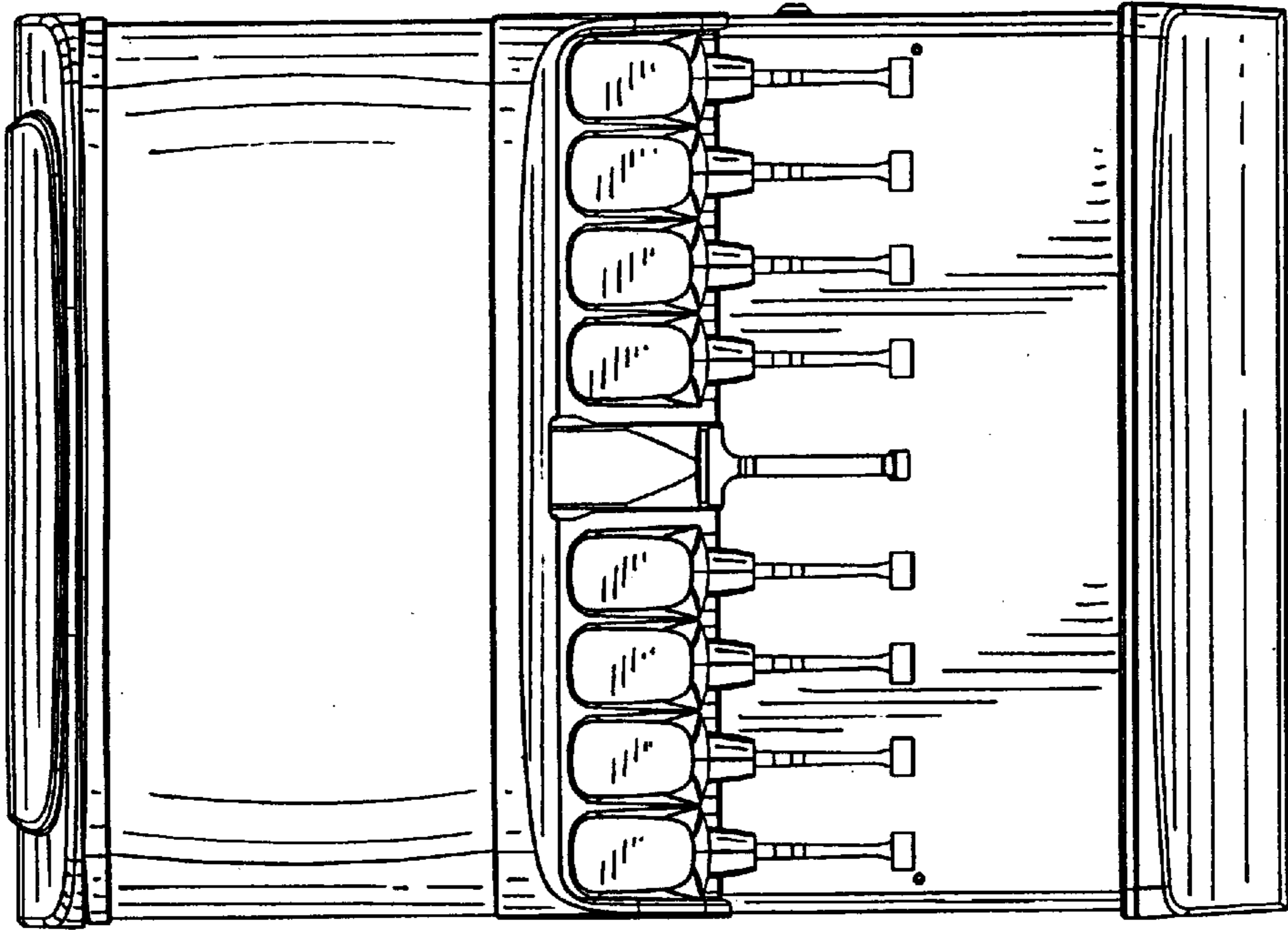

FIG. 9

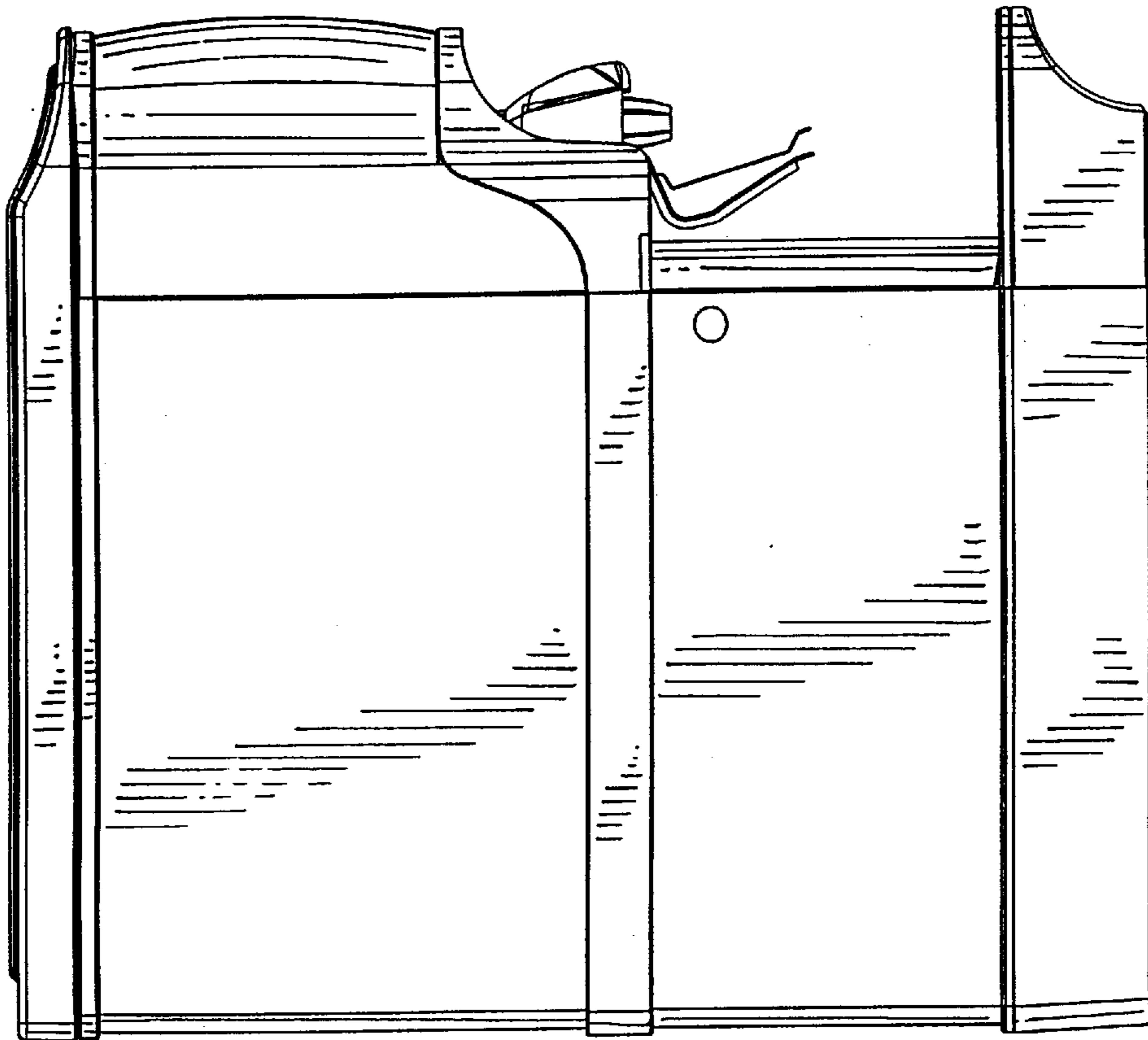

FIG. 12

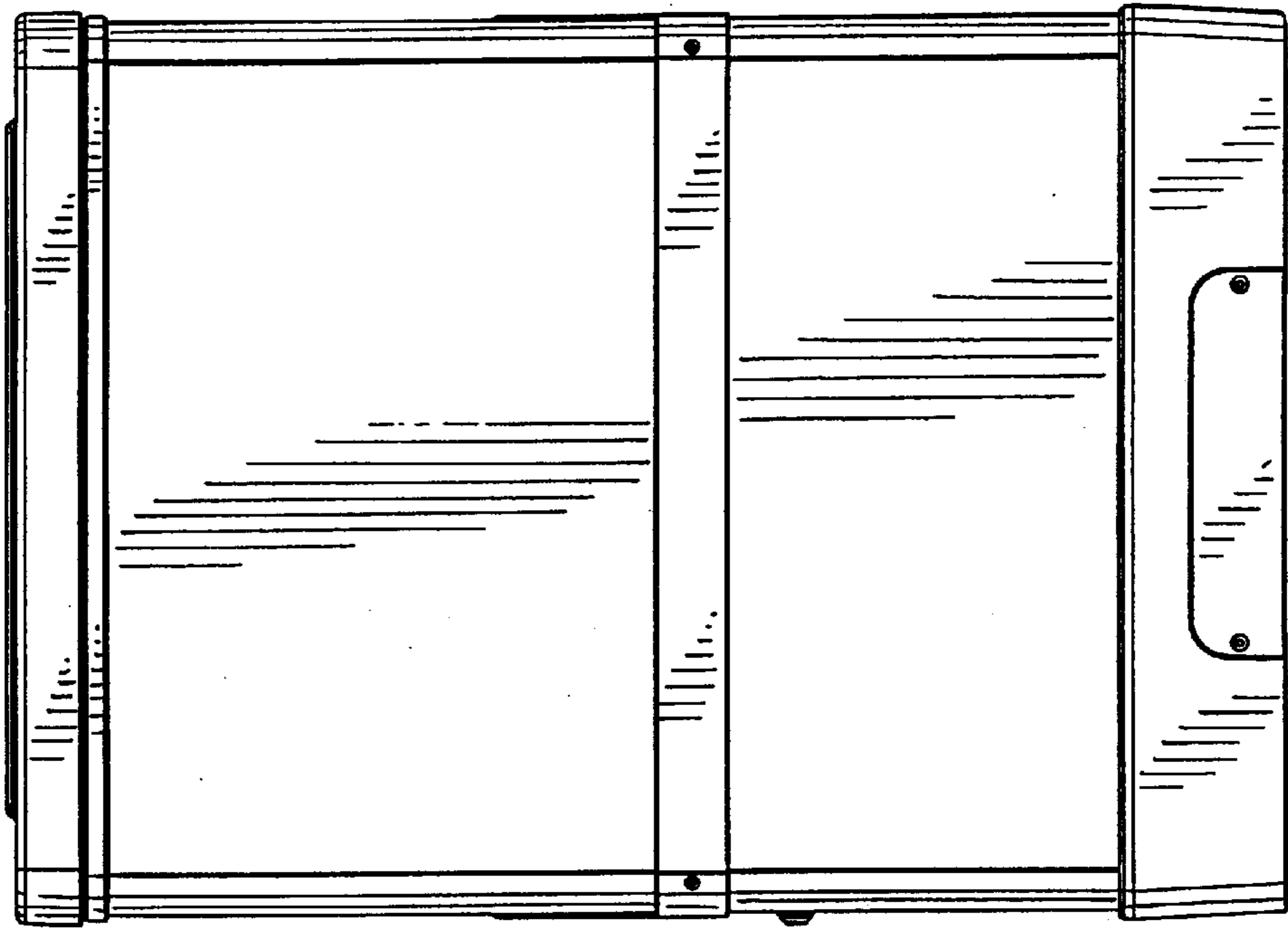

FIG. 11

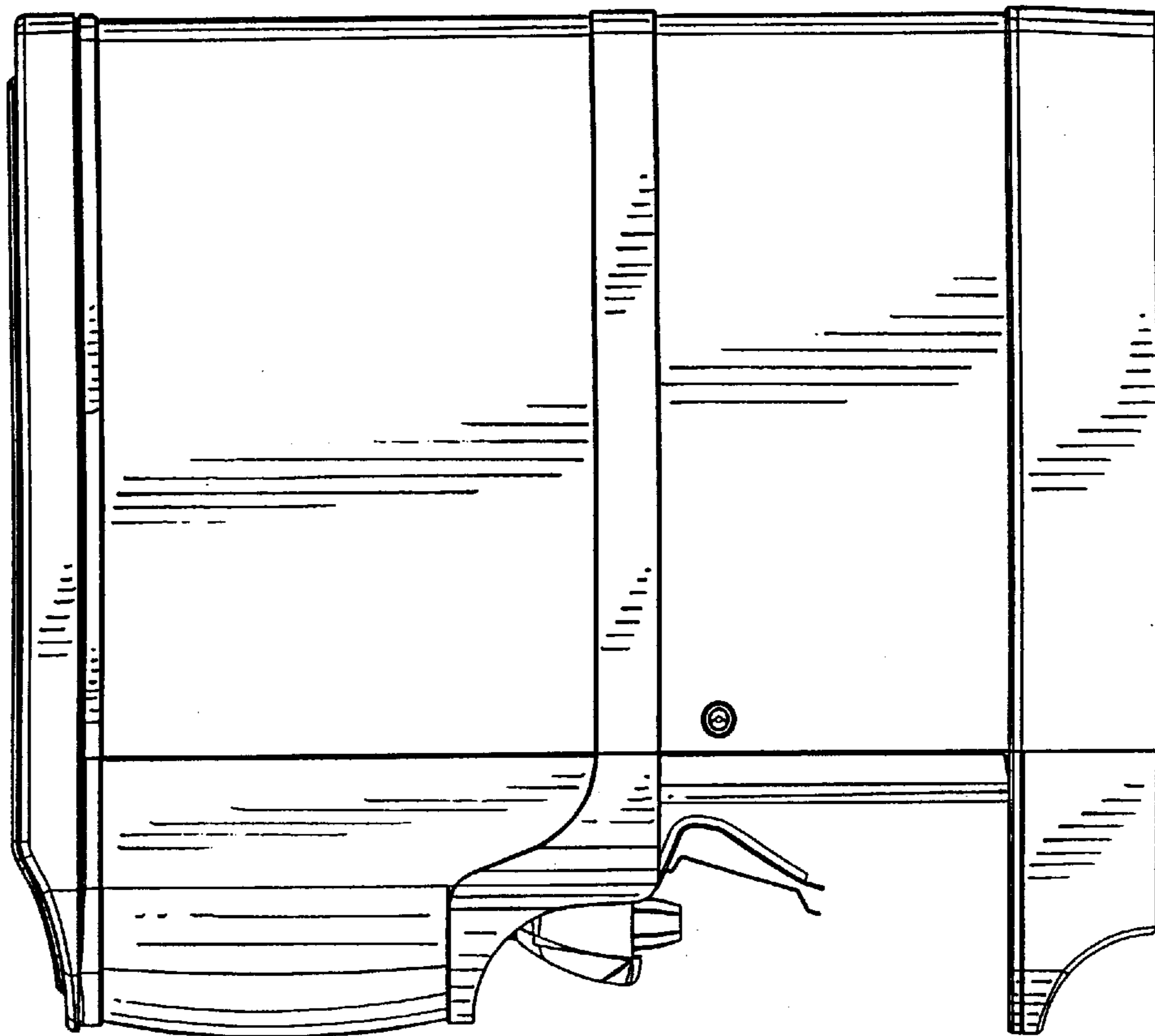

FIG.13

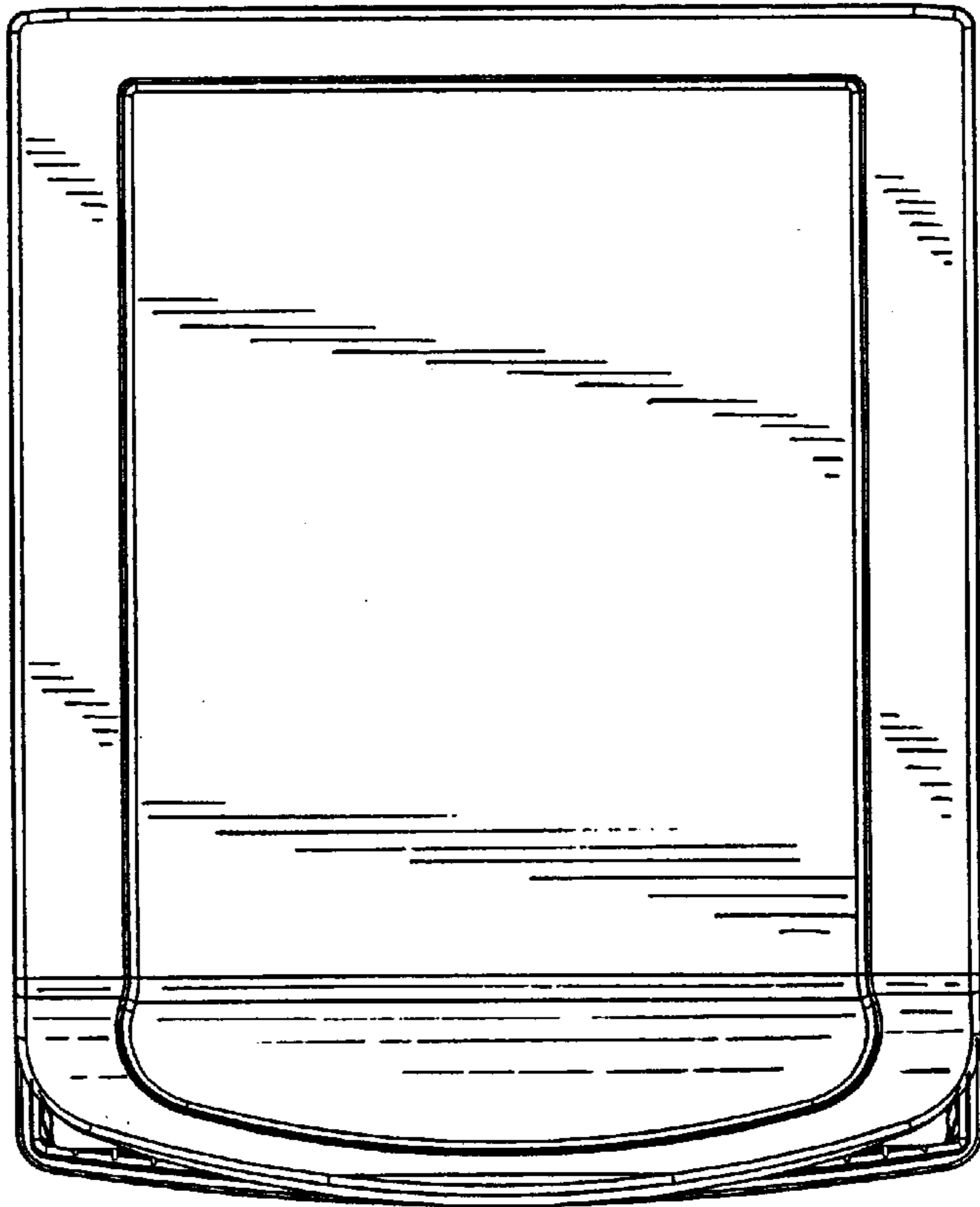
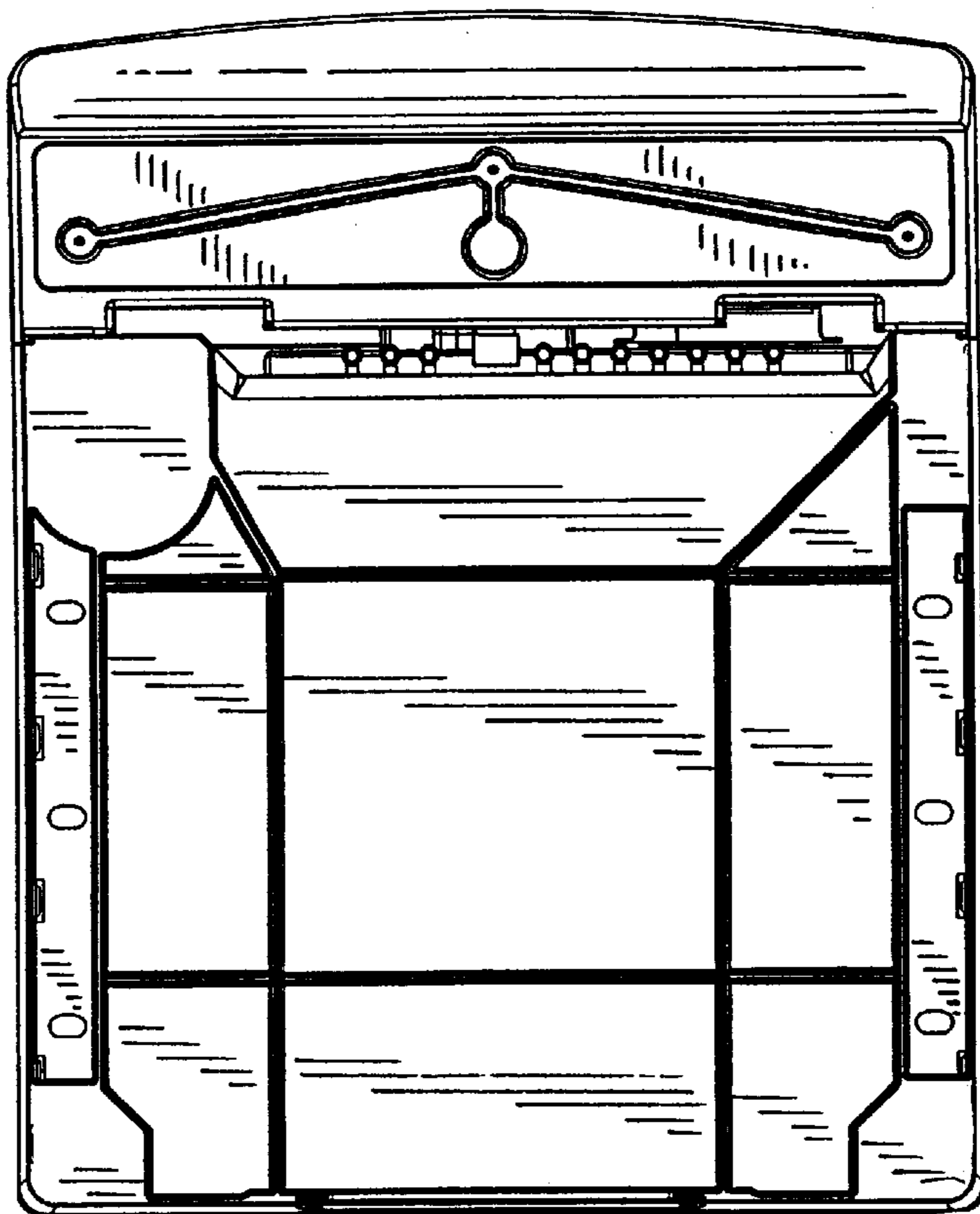

FIG.14



UNITED STATES PATENT AND TRADEMARK OFFICE
CERTIFICATE OF CORRECTION

PATENT NO. : Des. 486,687 S
DATED : February 17, 2004
INVENTOR(S) : Timothy B. Strandell

Page 1 of 1

It is certified that error appears in the above-identified patent and that said Letters Patent is hereby corrected as shown below:

Title page,
Item [57], **DESCRIPTION**, delete lines 19-20.

Signed and Sealed this

Twelfth Day of April, 2005

A handwritten signature in black ink on a light gray dotted background. The signature reads "Jon W. Dudas" in a cursive style.

JON W. DUDAS

Director of the United States Patent and Trademark Office