



US00D486678S

(12) **United States Design Patent**
Hightower

(10) **Patent No.:** **US D486,678 S**

(45) **Date of Patent:** **** Feb. 17, 2004**

(54) **MOUNTING MEMBER FOR A ROLL-OUT
DRAWER SYSTEM**

4,552,415 A * 11/1985 Fulterer 312/330.1
D287,556 S * 1/1987 Chien D6/491
D291,636 S * 9/1987 Rechberg D6/510
D399,725 S * 10/1998 Baker D8/354

(75) Inventor: **Robert C. Hightower**, High Point, NC
(US)

* cited by examiner

(73) Assignee: **Tenn-Tex Plastics, Inc.**, Colfax, NC
(US)

Primary Examiner—Robert M. Spear

Assistant Examiner—Elizabeth A. Albert

(**) Term: **14 Years**

(74) *Attorney, Agent, or Firm*—Myers Bigel Sibley &
Sajovec

(21) Appl. No.: **29/160,653**

(57) **CLAIM**

(22) Filed: **May 13, 2002**

The ornamental design for a mounting member for a roll-out
drawer system, as shown and described.

(51) **LOC (7) Cl.** **06-04**

DESCRIPTION

(52) **U.S. Cl.** **D6/510; D8/349**

(58) **Field of Search** D6/491, 510; D8/349,
D8/354, 363, 376, 377, 380, 400; 16/95 R;
248/200, 201, 205.1; 312/330.1, 334.1,
334.5, 334.7, 334.8, 334.21, 334.23, 334.27,
334.28, 334.29, 334.34, 348.1, 348.2; 384/20,
21, 22

FIG. 1 is a front perspective view of a mounting member for
a roll-out drawer system showing the design;

FIG. 2 is a front view thereof;

FIG. 3 is a side view thereof;

FIG. 4 is a rear view thereof;

FIG. 5 is an opposite side view thereof;

FIG. 6 is a bottom view thereof; and,

FIG. 7 is a top view thereof.

The broken lines showing environment in the drawings are
for illustrative purposes only and form no part of the claimed
design.

(56) **References Cited**

U.S. PATENT DOCUMENTS

1,060,547 A * 4/1913 Hamacheck 312/334.8
D218,321 S * 8/1970 Ley D6/510
D264,293 S * 5/1982 Litchfield et al. D6/510

1 Claim, 3 Drawing Sheets

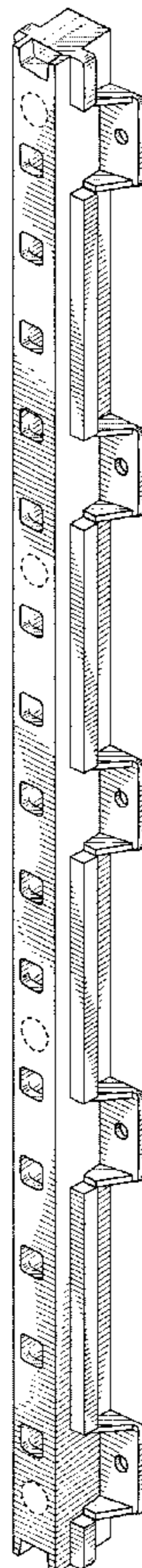

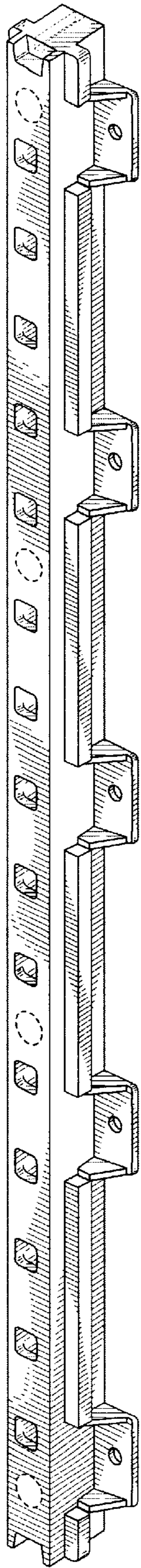

FIG. 1.

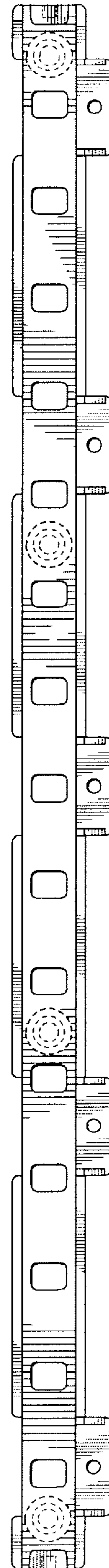

FIG. 2.



FIG. 3.

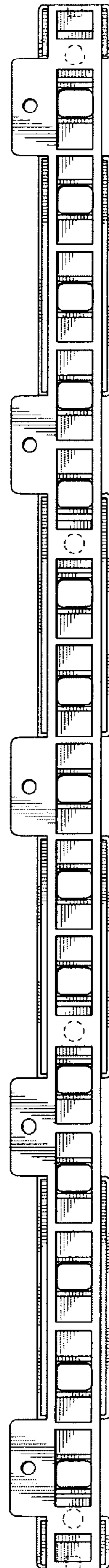

FIG. 4.

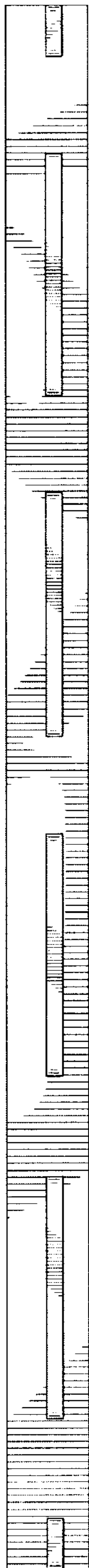

FIG. 5.

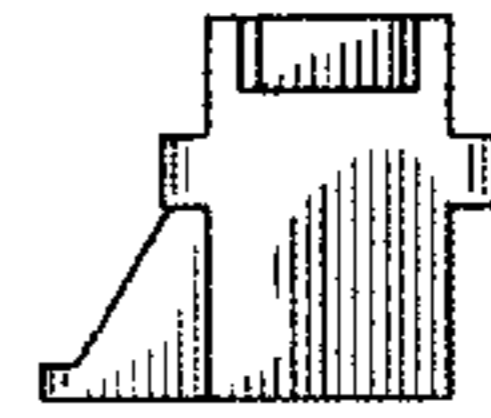

FIG. 6.

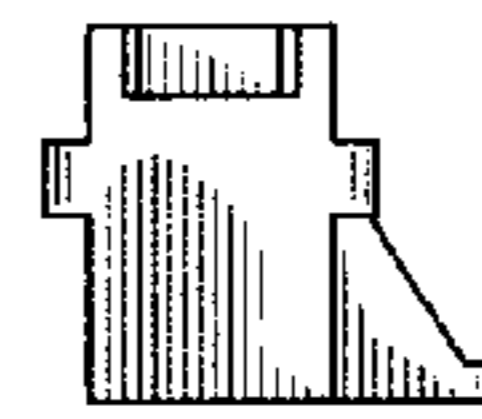

FIG. 7.