



US00D486613S

(12) **United States Design Patent**  
**Stern et al.**

(10) **Patent No.:** **US D486,613 S**

(45) **Date of Patent:** **\*\* Feb. 10, 2004**

(54) **DOG HOUSE DRYER**

(75) Inventors: **Jules Stern**, Spring Valley, NY (US);  
**David Stern**, Montebello, NY (US);  
**Kenneth Stern**, Montebello, NY (US);  
**Peter Stankus**, Pearl River, NY (US)

(73) Assignee: **Metropolitan Vacuum Cleaner Co., Inc.**, Suffern, NY (US)

(\*\*) Term: **14 Years**

(21) Appl. No.: **29/179,666**

(22) Filed: **Apr. 14, 2003**

(65) **Prior Publication Data**

(65)  
(51) **LOC (7) Cl.** ..... **30-99**

(52) **U.S. Cl.** ..... **D30/158; D30/108**

(58) **Field of Search** ..... **D30/158, 108, D30/109, 126; 119/673, 676, 677, 678, 606, 668, 753, 756; 34/523; D21/511**

(56) **References Cited**

**U.S. PATENT DOCUMENTS**

3,596,636 A \* 8/1971 Stobaugh ..... 119/174  
D333,367 S \* 2/1993 Pirri ..... D30/110

5,448,966 A \* 9/1995 McKinnon et al. .... 119/676  
D420,470 S \* 2/2000 Kolozsvari et al. .... D30/108  
D443,732 S \* 6/2001 Gelhar ..... D30/108

\* cited by examiner

*Primary Examiner*—Pamela Burgess

(74) *Attorney, Agent, or Firm*—Michael E. Zall

(57) **CLAIM**

I claim the ornamental design for the dog house dryer, as shown and described.

**DESCRIPTION**

FIG. 1 is a perspective view of the dog house dryer from the right front side showing our new design; FIG. 2 is a front view thereof; FIG. 3 is a rear view thereof; FIG. 4 is a left view thereof; FIG. 5 is a right view thereof; FIG. 6 is a top view thereof; FIG. 7 is a bottom view thereof; and, FIG. 8 is a perspective view from the right front side thereof, the broken lines showing accessories are for illustrative purposes only and form no part of the claimed design. The broken lines in FIGS. 3, 4, 5 and 6 are for illustrative purposes only and form no part of the claimed design.

**1 Claim, 8 Drawing Sheets**

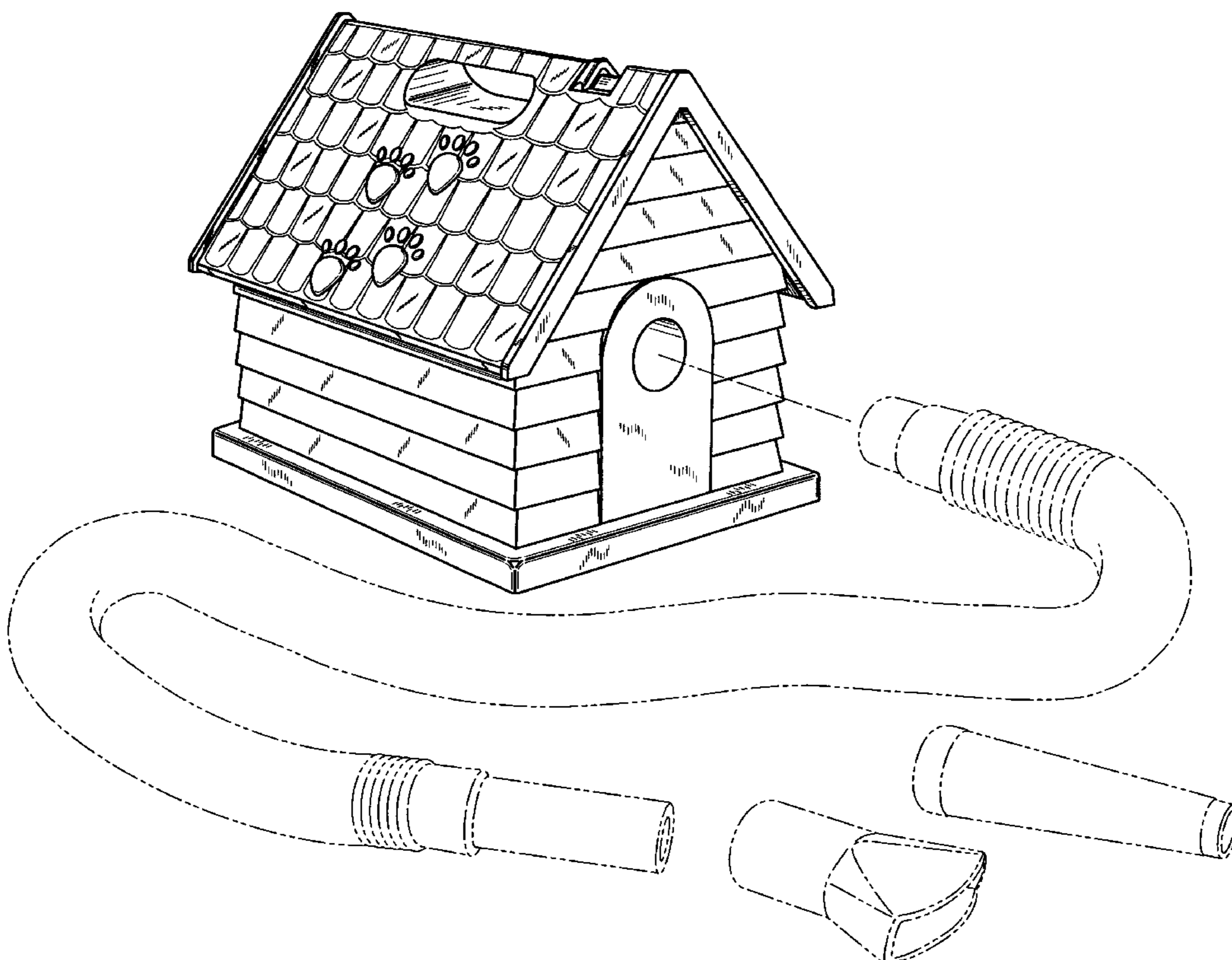

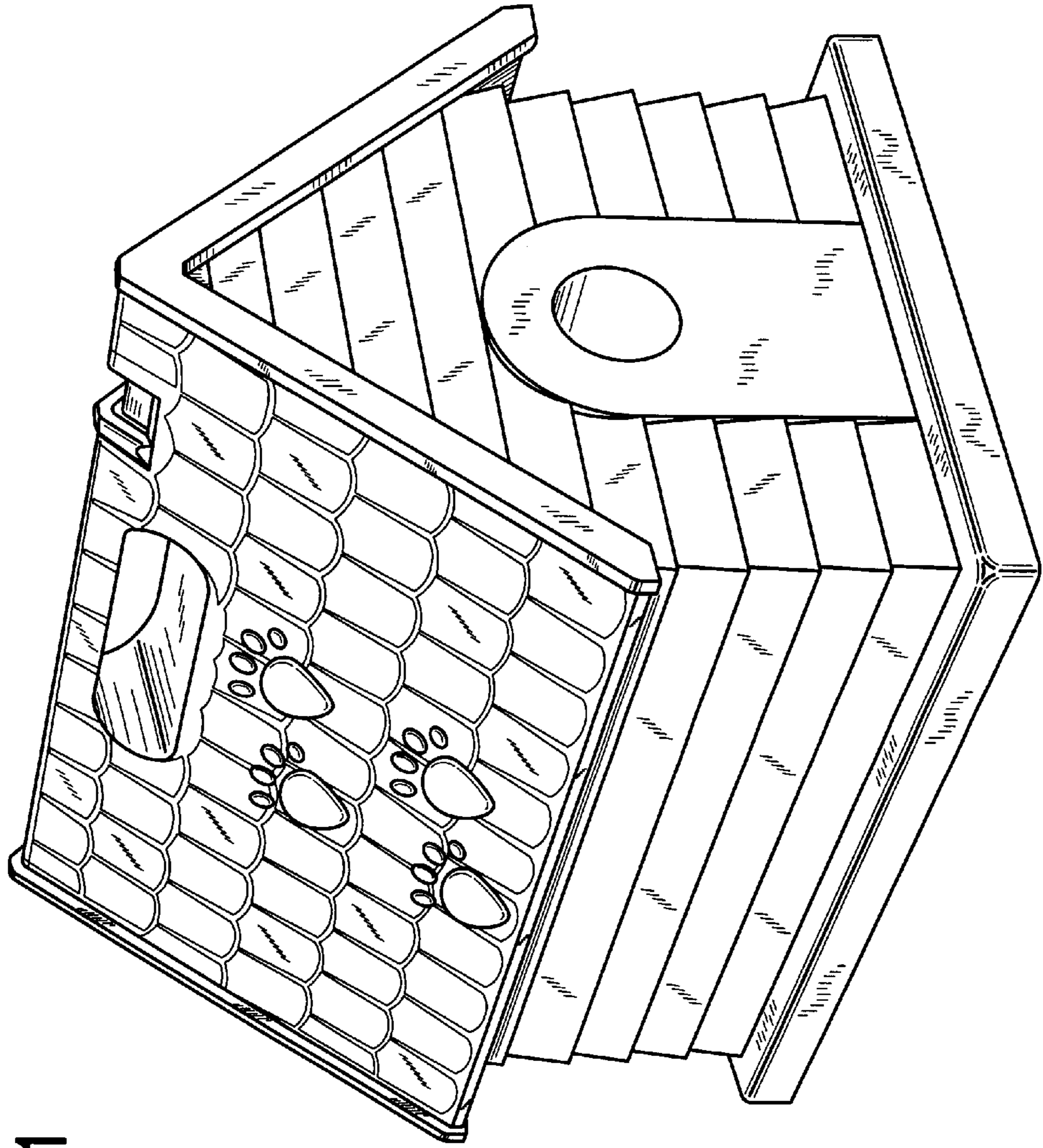

FIG. 1

FIG. 2

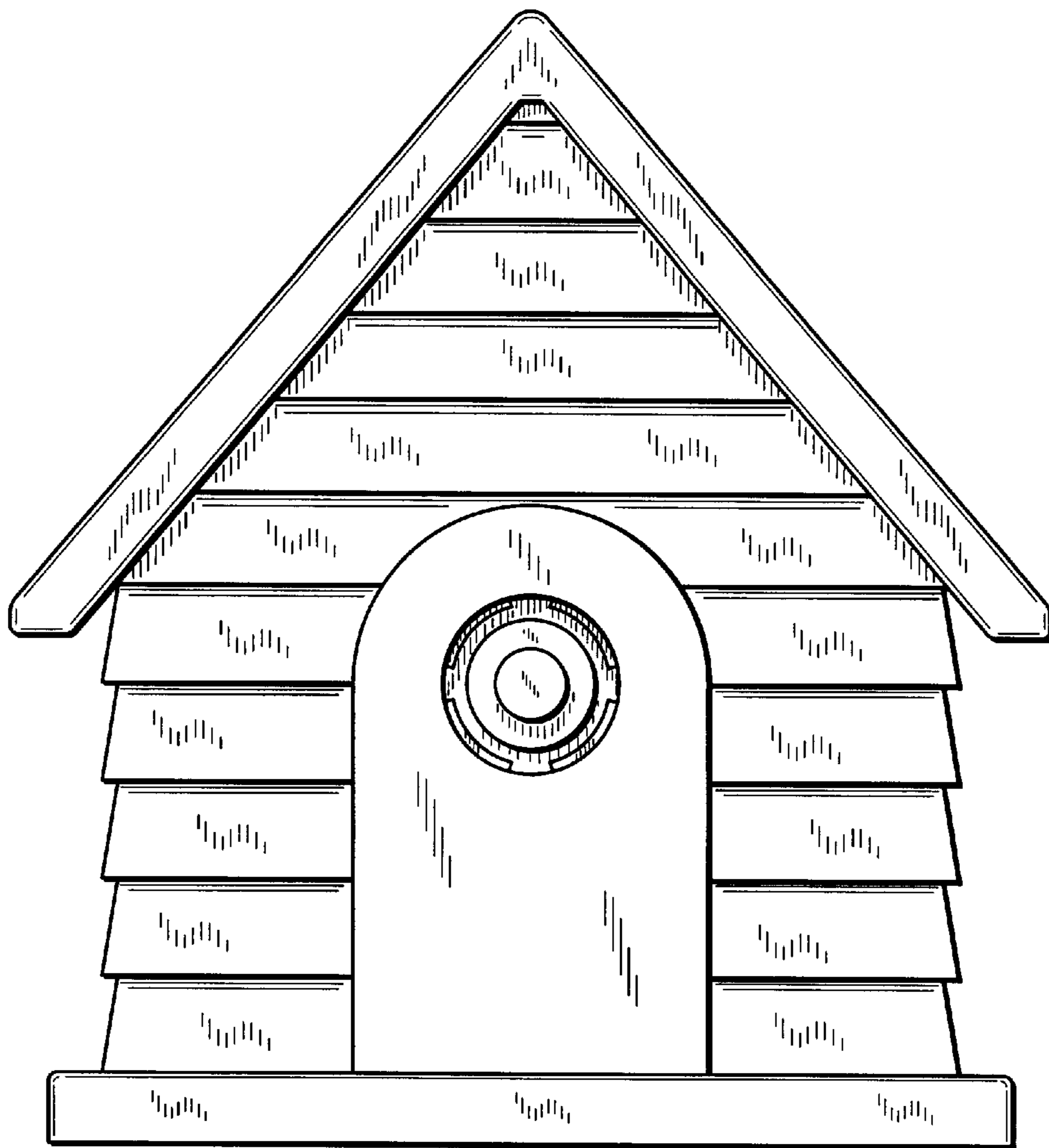

FIG. 3

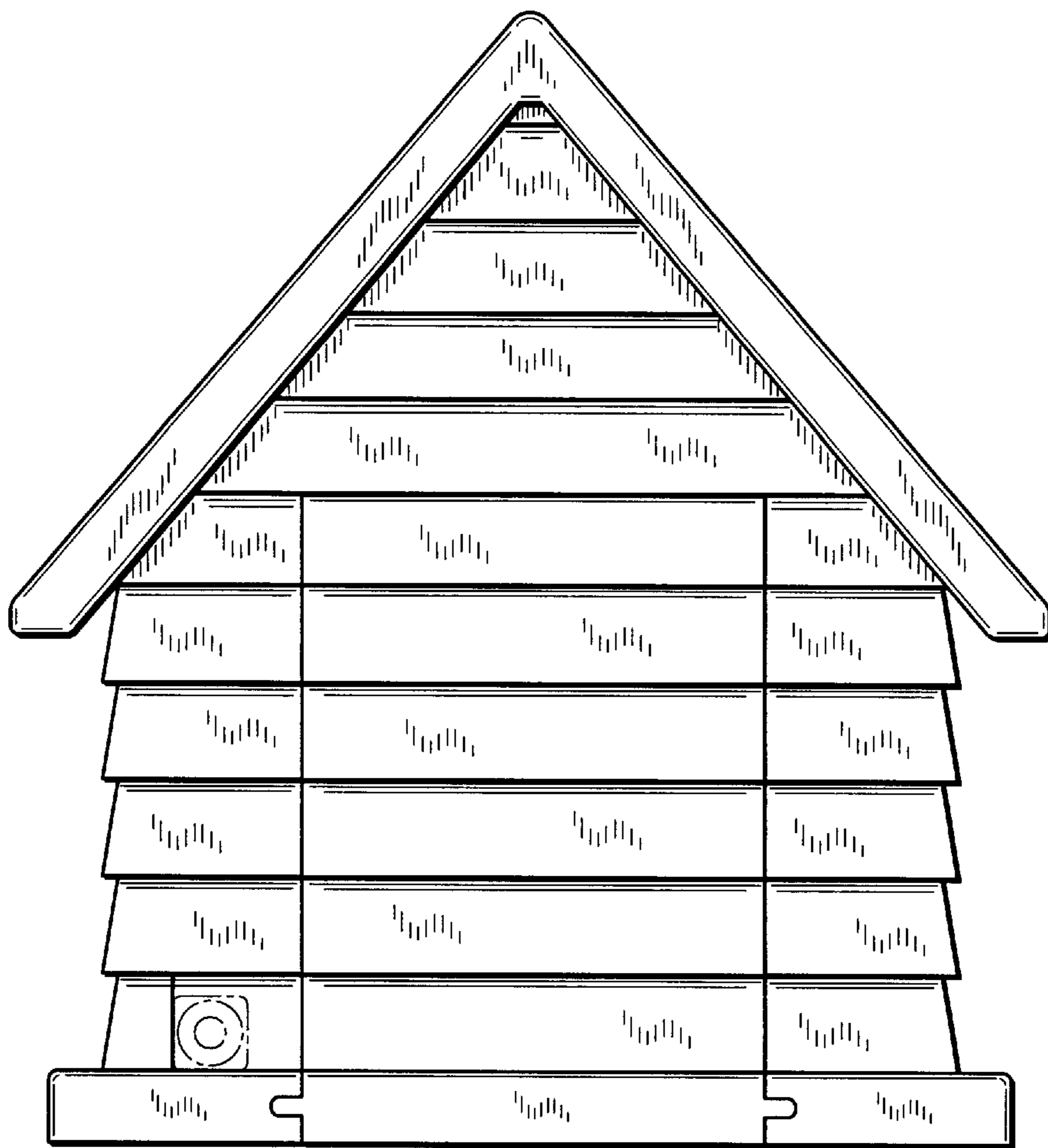



FIG. 4

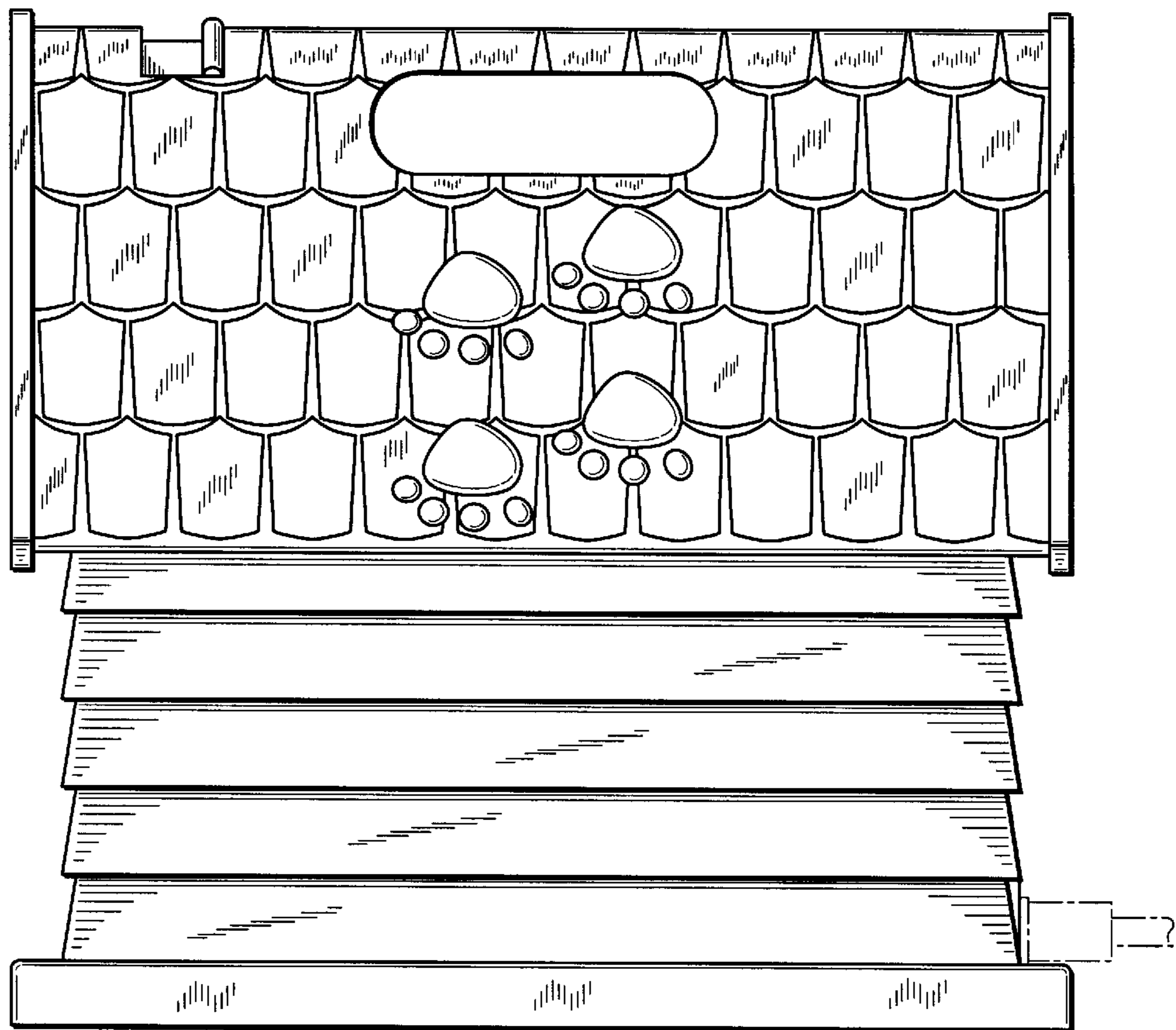

FIG. 5

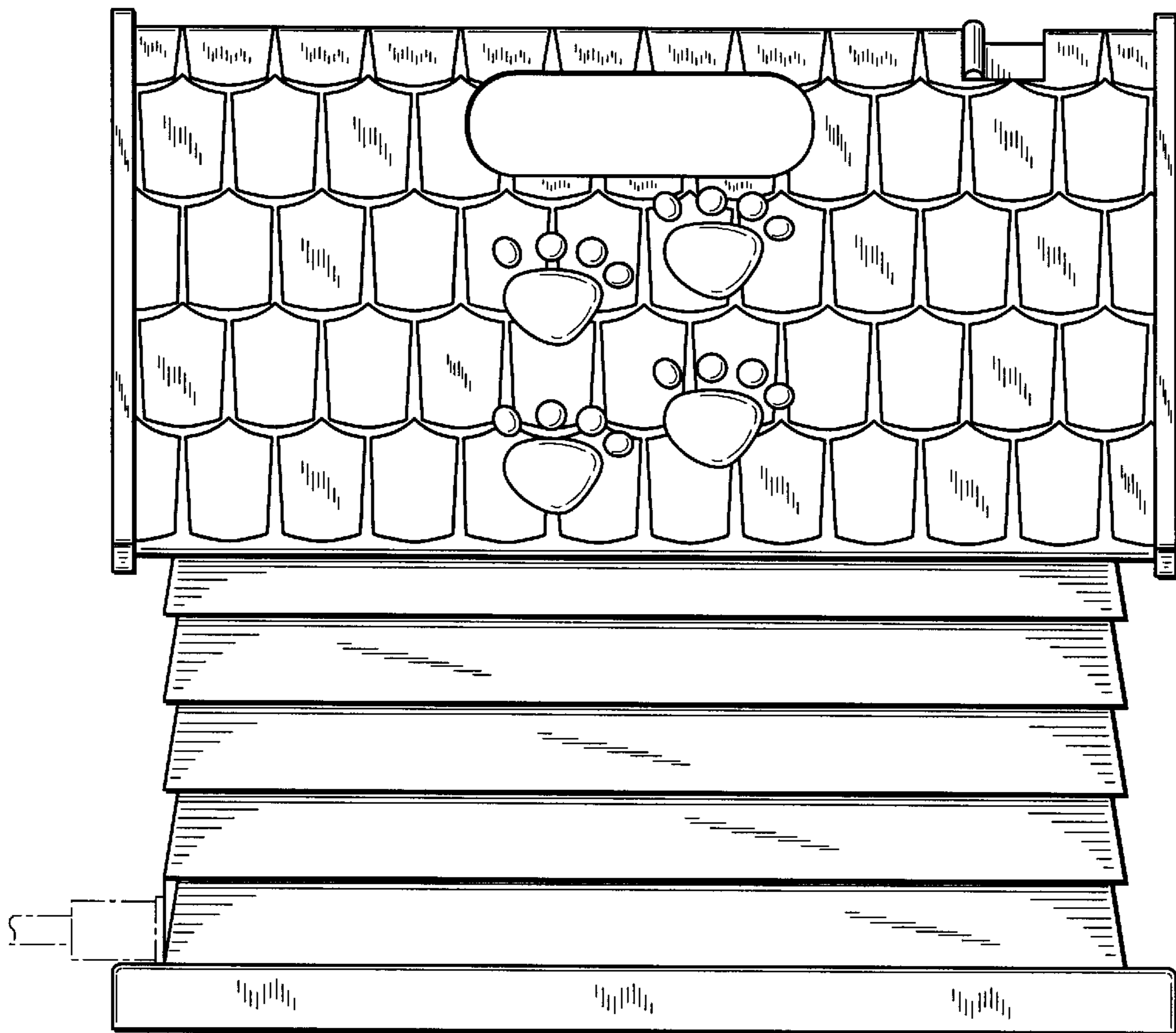

FIG. 6

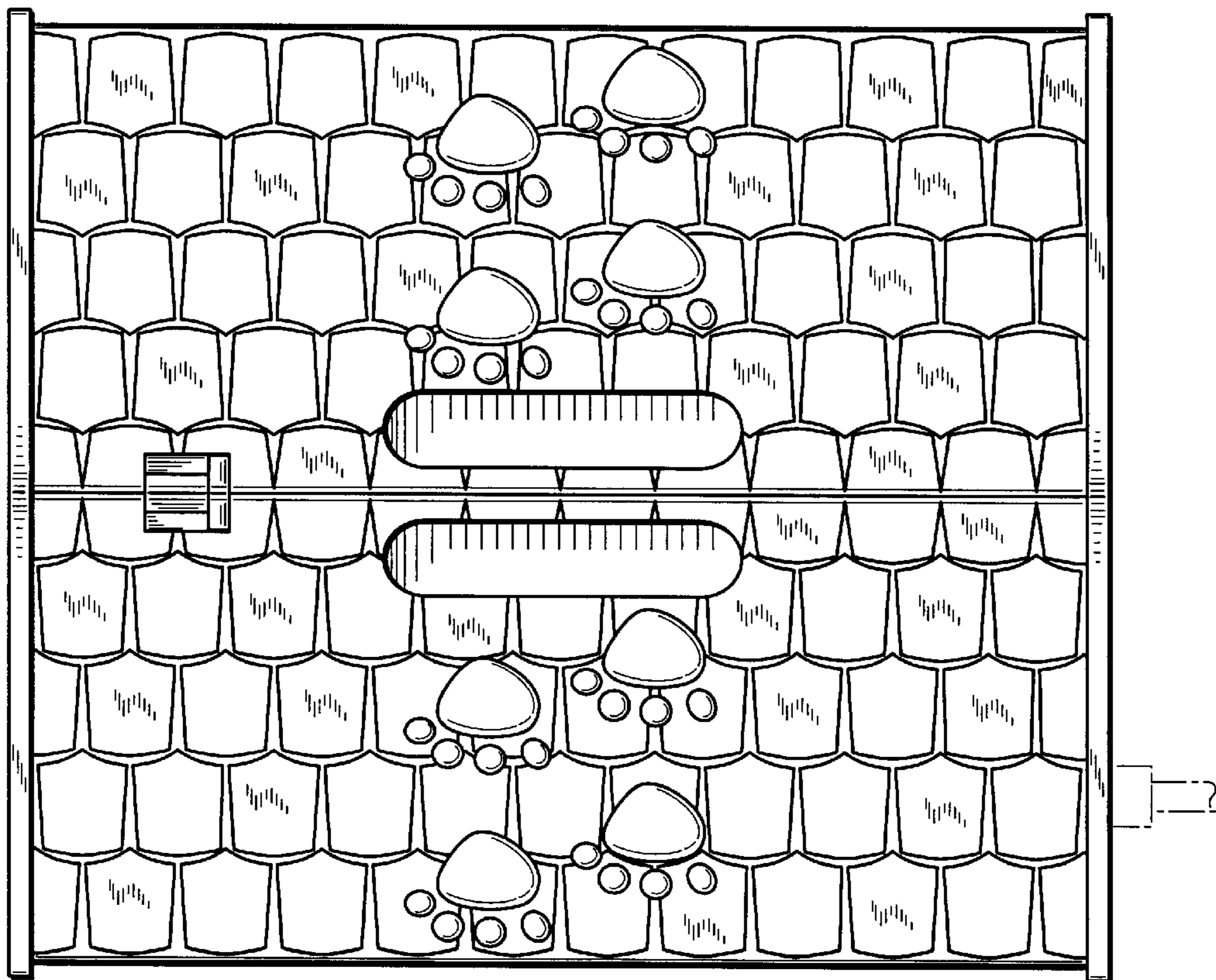

FIG. 7

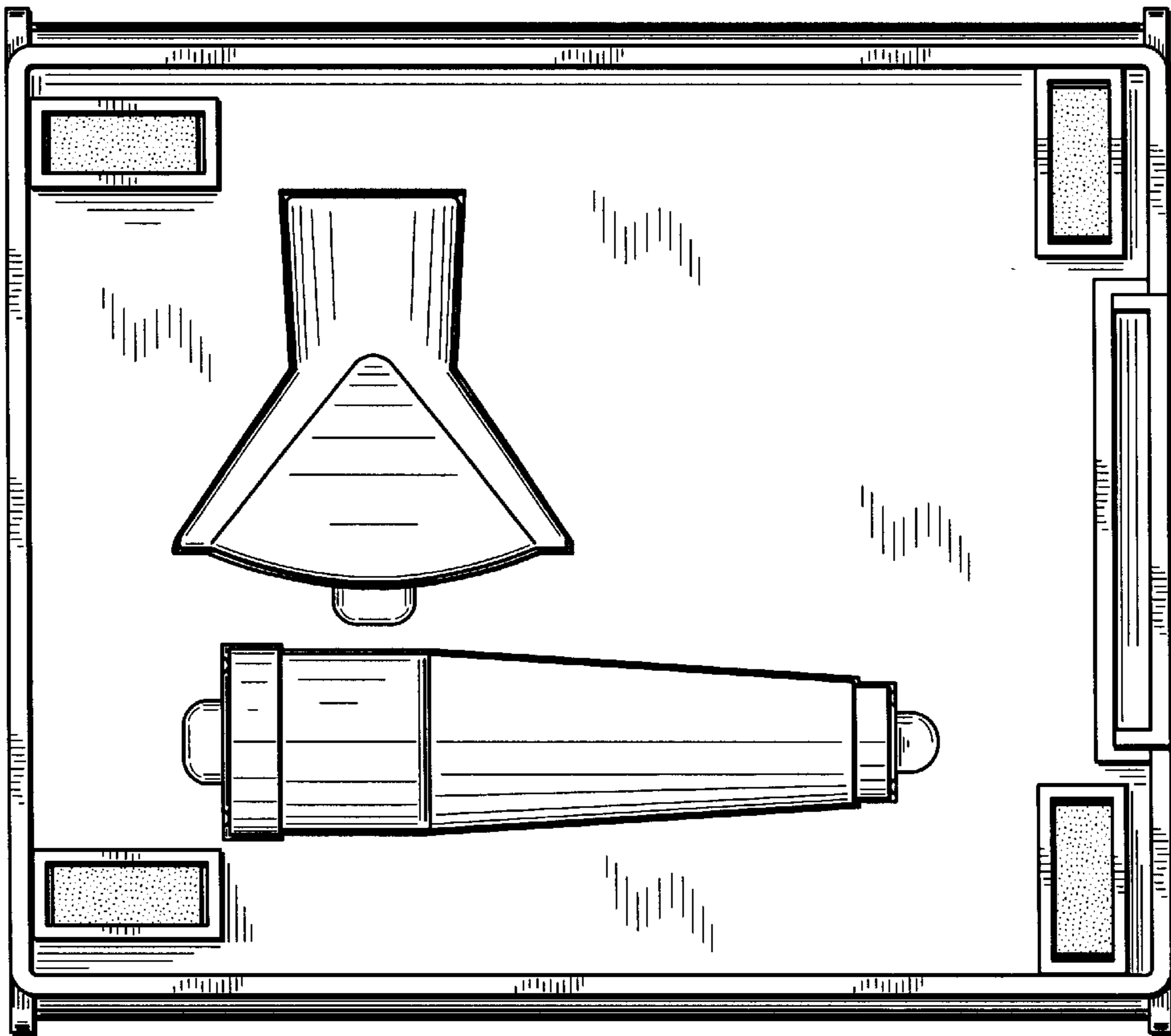



FIG. 8

