



US00D486610S

(12) **United States Design Patent**
Alivo, Jr.

(10) **Patent No.: US D486,610 S**

(45) **Date of Patent: ** Feb. 10, 2004**

(54) **BOWLER'S WRIST SUPPORT**

(76) Inventor: **Martin J. Alivo, Jr.**, 4785B Cara Marie Ct., Brookfield, WI (US) 53005

(**) Term: **14 Years**

(21) Appl. No.: **29/169,970**

(22) Filed: **Oct. 29, 2002**

(51) **LOC (7) Cl.** **29-02**

(52) **U.S. Cl.** **D29/120.1**

(58) **Field of Search** D29/120.1, 121.1,
D29/113; D24/190; 2/16, 910, 20, 170;
602/21; 473/62

(56) **References Cited**

U.S. PATENT DOCUMENTS

3,779,550	A	*	12/1973	Benoun et al.	473/62
3,790,168	A	*	2/1974	Hashimoto	473/62
4,183,098	A	*	1/1980	Knowles, Jr.	2/16
4,479,648	A		10/1984	Alivo, Jr.		
D295,897	S	*	5/1988	Thimm-Kelly	D24/190
4,925,187	A	*	5/1990	Fleenor et al.	473/62
5,445,566	A	*	8/1995	Hayes	473/62
5,819,313	A	*	10/1998	McCrane	2/16

D427,383	S	*	6/2000	Inman	D29/113
D456,081	S	*	4/2002	Bell et al.	D24/190
6,561,994	B1	*	5/2003	Mills et al.	602/20

* cited by examiner

Primary Examiner—Lucy Lieberman
(74) *Attorney, Agent, or Firm*—Andrus, Scales, Starke & Sawall, LLP

(57) **CLAIM**

The ornamental design for a bowler's wrist support, as shown.

DESCRIPTION

FIG. 1 is a perspective view of a bowler's wrist support showing my new ornamental design; FIG. 2 is a front view of the bowler's wrist support; FIG. 3 is a view of the bowler's wrist support taken from the right side of FIG. 2; FIG. 4 is a view of the bowler's wrist support taken from the left side of FIG. 2; FIG. 5 is a rear view of the bowler's wrist support; FIG. 6 is a bottom view of the bowler's wrist support; and, FIG. 7 is a top view of the bowler's wrist support.

1 Claim, 2 Drawing Sheets

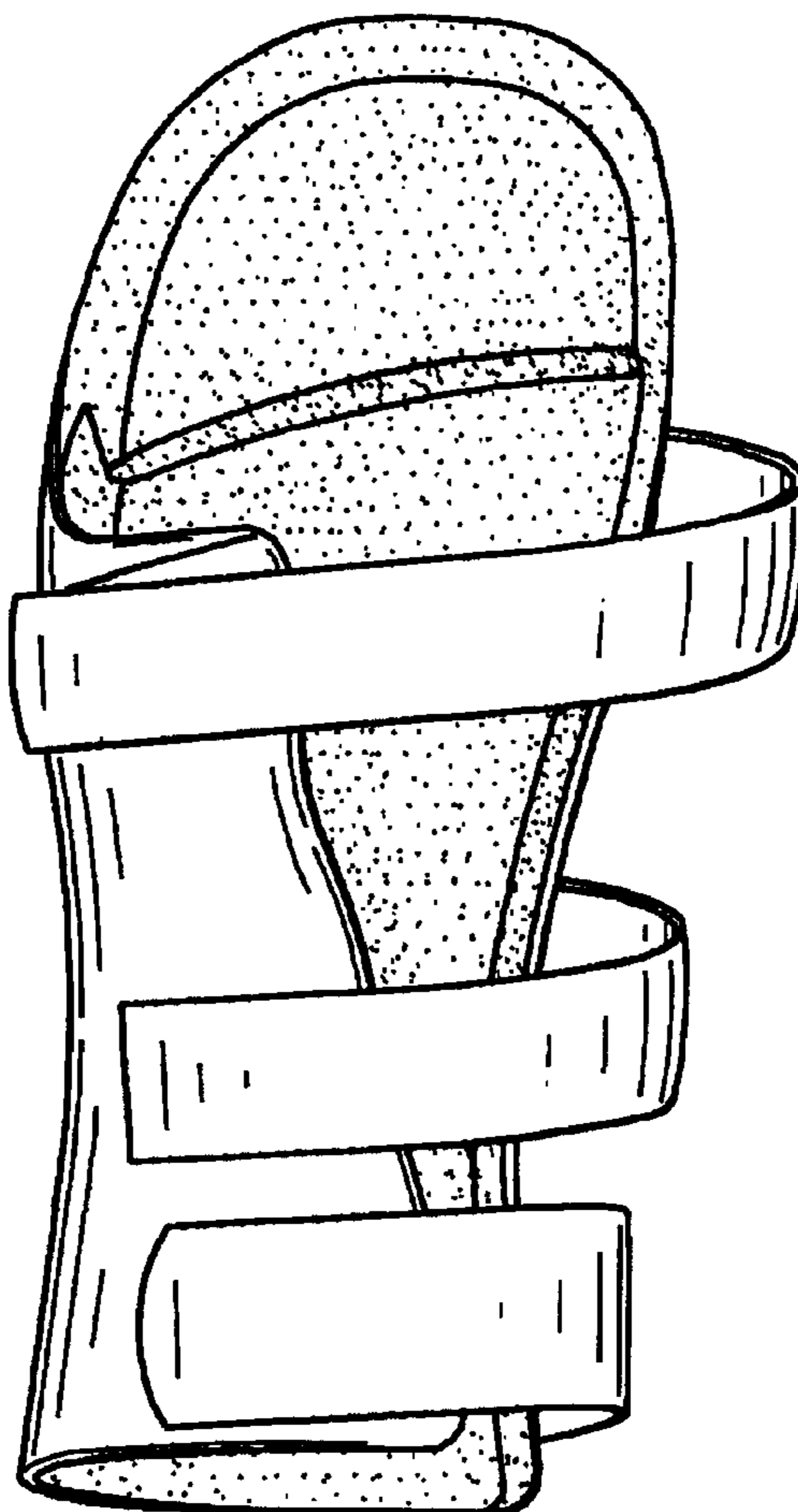

FIG. 1

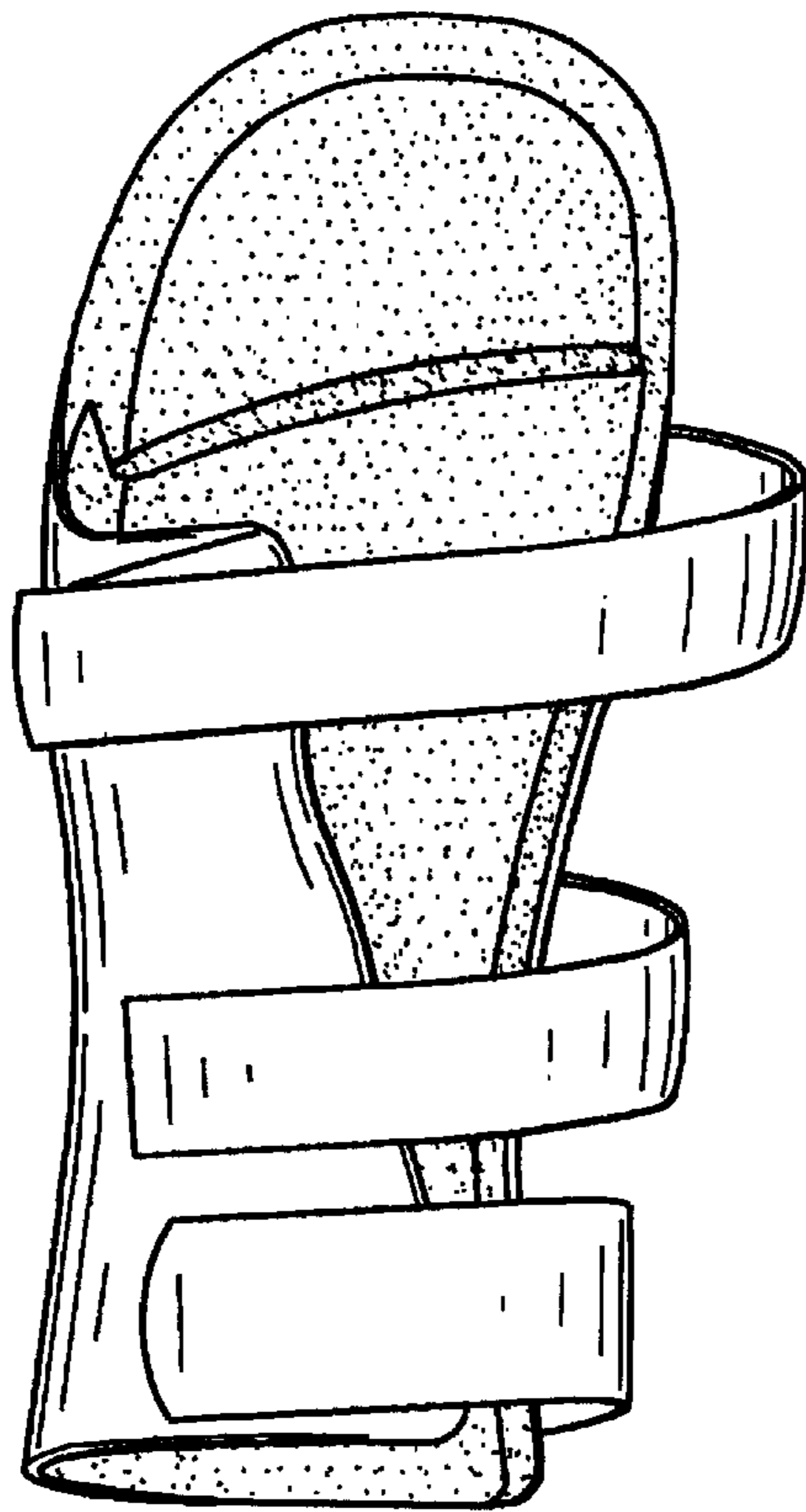
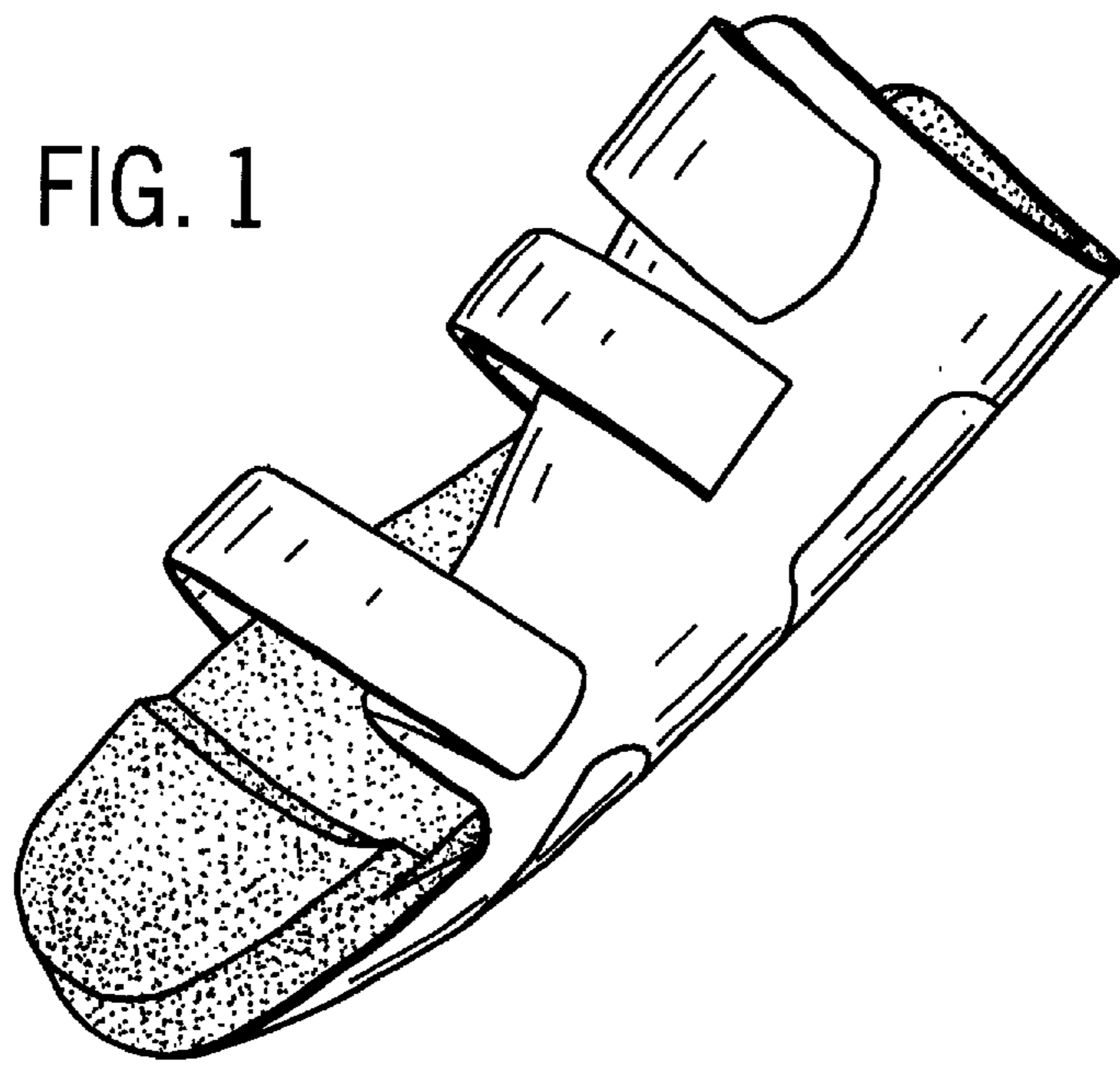

FIG. 2

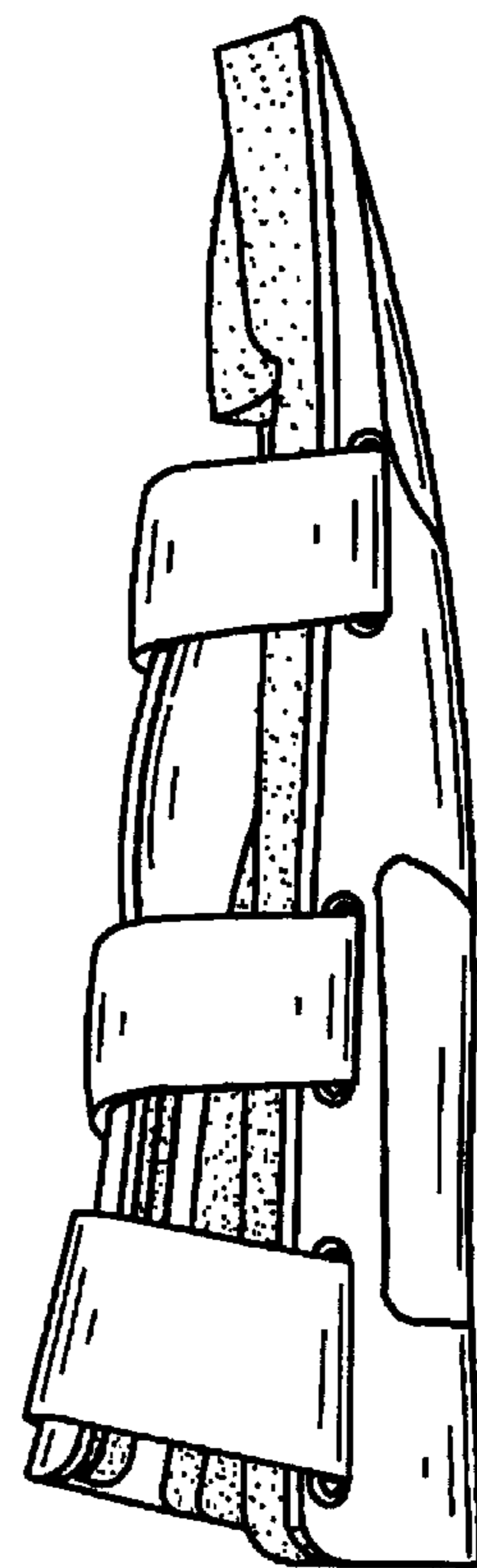

FIG. 3

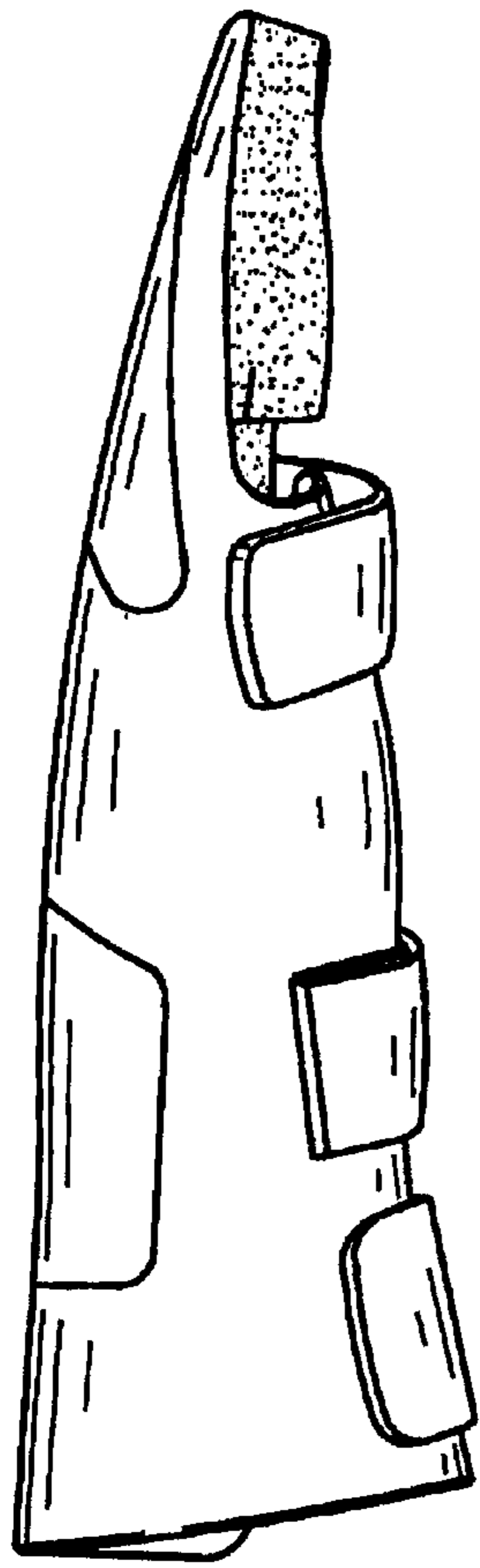

FIG. 4

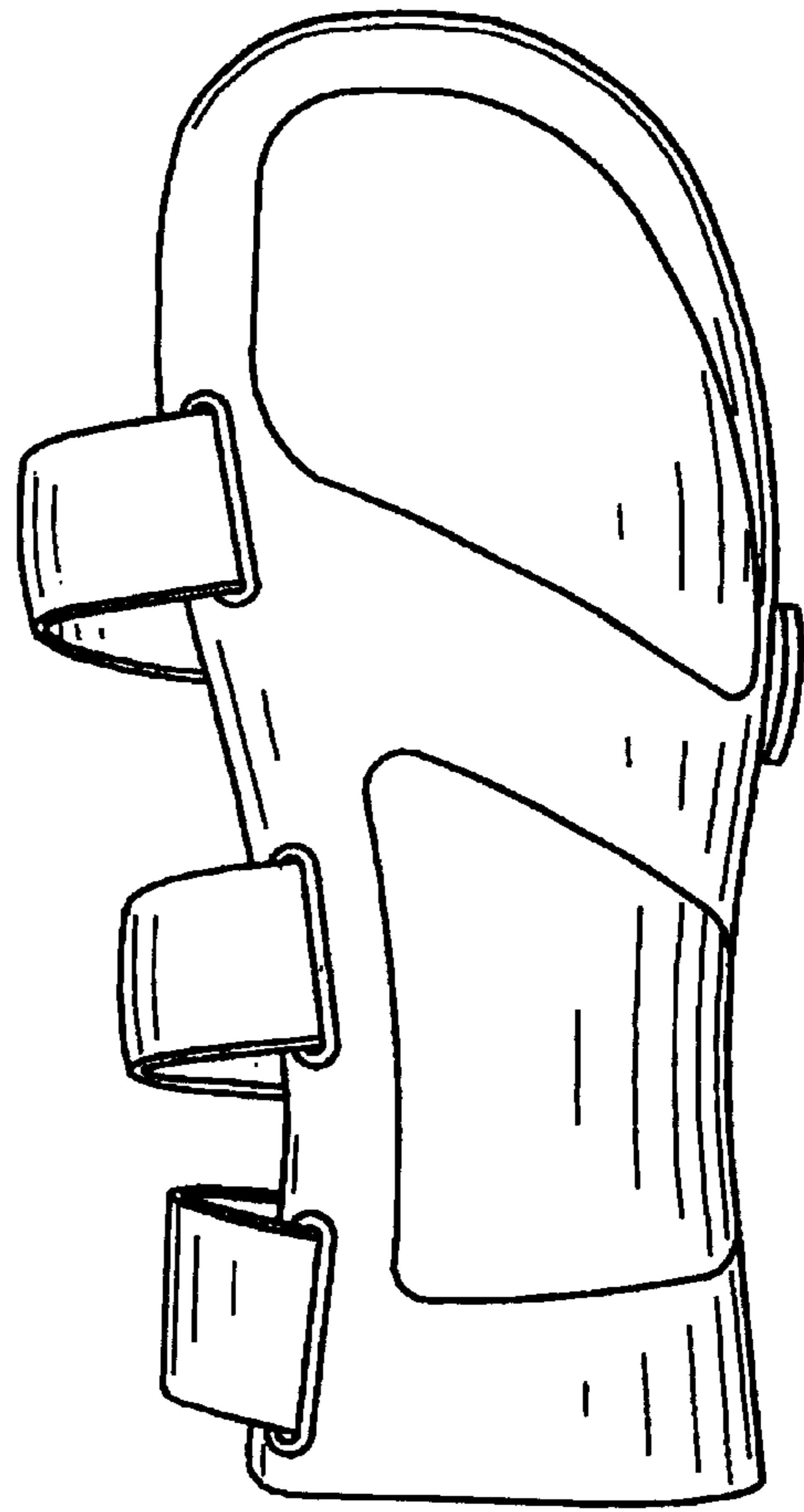

FIG. 5

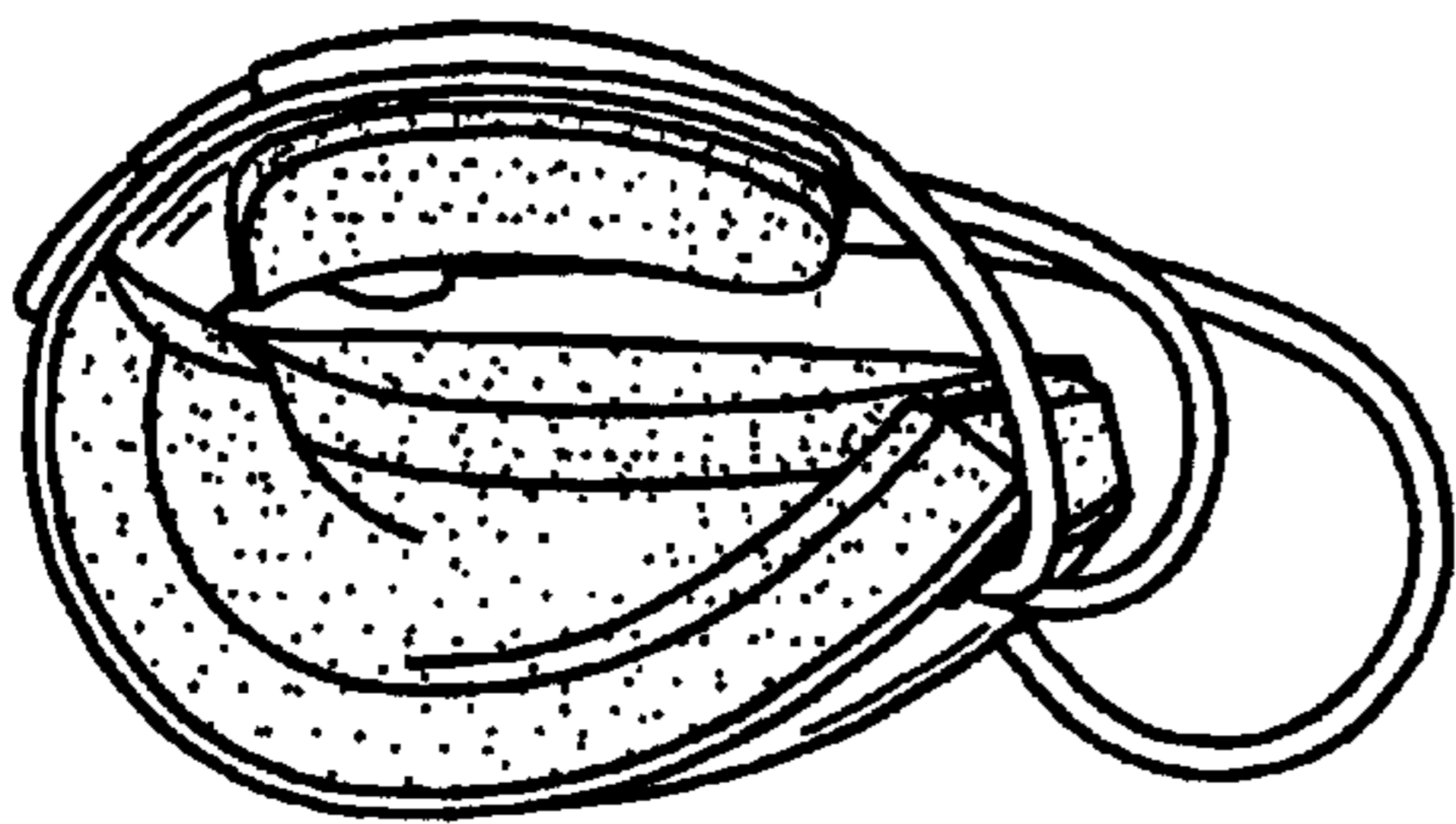

FIG. 6

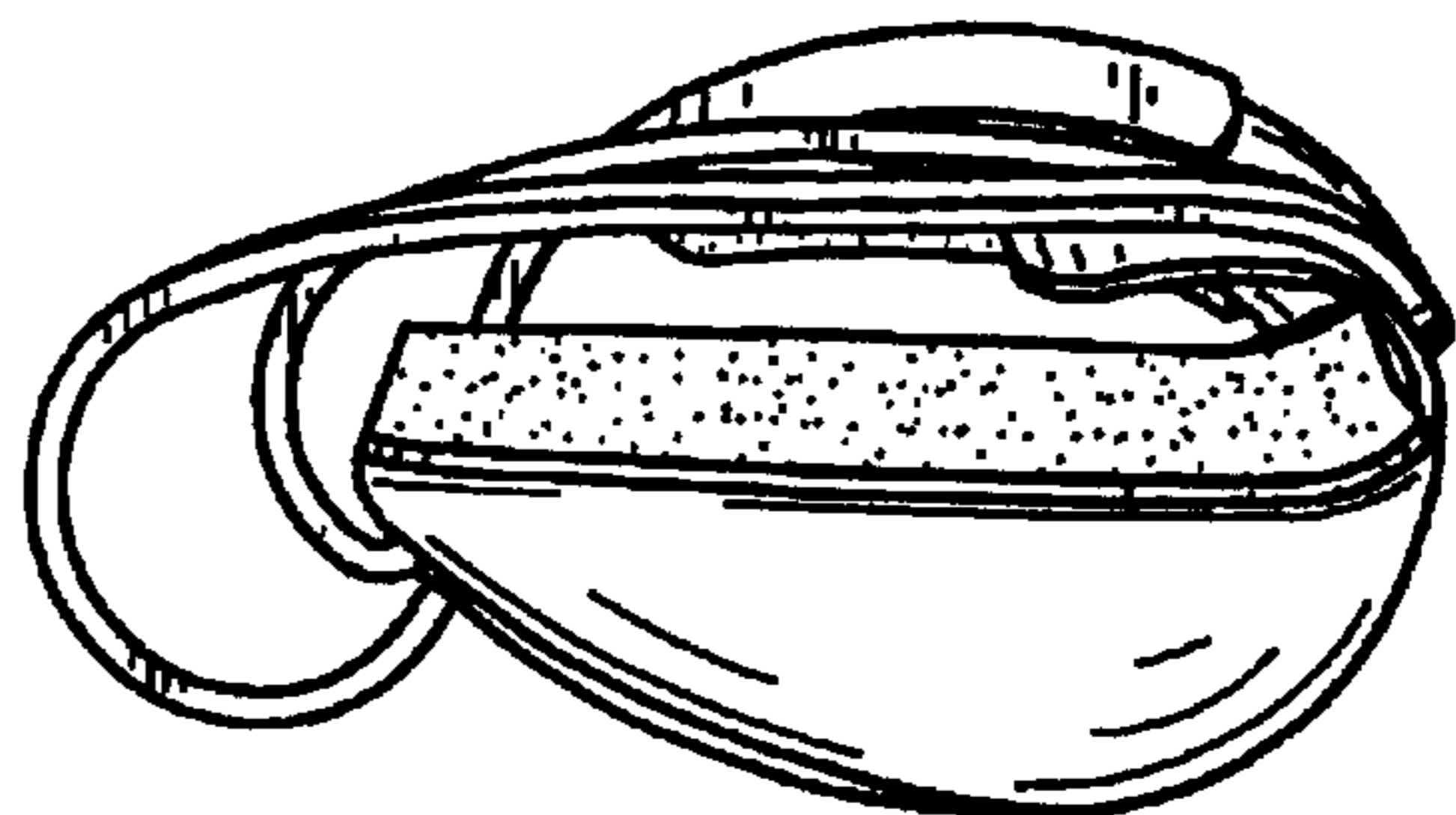

FIG. 7