



US00D486512S

(12) **United States Design Patent**  
**Arnold et al.**

(10) **Patent No.:** **US D486,512 S**

(45) **Date of Patent:** **\*\* Feb. 10, 2004**

(54) **HAND-HELD PRINTER**

D455,454 S \* 4/2002 Swyst et al. .... D18/14

(75) **Inventors:** **Gregory B. Arnold**, Centerville, OH (US); **James A. Makley**, Springboro, OH (US); **Gregory de Swarte**, Cincinnati, OH (US); **Peter C. Mason, Jr.**, Wyoming, OH (US)

(73) **Assignee:** **Paxar Corporation**, White Plains, NY (US)

(\*\*) **Term:** **14 Years**

(21) **Appl. No.:** **29/164,332**

(22) **Filed:** **Jul. 24, 2002**

(51) **LOC (7) Cl.** ..... **19-02**

(52) **U.S. Cl.** ..... **D18/14; D18/19**

(58) **Field of Search** ..... D18/14-19, 50, D18/52, 54-56; D14/217, 429; 156/361, 384, 577, 579, DIG. 47, 49, 51; 347/171, 218, 22; 235/385, 432, 487, 488; 346/136; 400/61, 73, 103; 361/684; 101/103, 106, 327, 368, 371, 405, 406; 118/256, 257

(56) **References Cited**

**U.S. PATENT DOCUMENTS**

D238,101 S	*	12/1975	Mulholland	.....	D18/19
D295,535 S	*	5/1988	Reinke	.....	D18/19
D305,131 S	*	12/1989	Sato et al.	.....	D18/19
5,227,617 A		7/1993	Christopher		
D349,920 S	*	8/1994	Wendt et al.	.....	D18/14
D360,890 S	*	8/1995	Tremlett	.....	D18/19
5,486,259 A		1/1996	Goodwin		
D389,859 S	*	1/1998	Thuma et al.	.....	D18/14
D409,230 S	*	5/1999	Gilbertson et al.	.....	D18/14

**OTHER PUBLICATIONS**

Pathfinder® Plus Printer; Monarch Marking Systems; A-704, B-19216, 9/93 Brochure.

Monarch DOS Based Pathfinder® Ultra® System; Paxar; A-952, 4/00 Brochure.

Pathfinder® Labeler; Portable Electronic Marking System; Monarch Marking; A-22, B-16112, 12/86 Brochure.

Pathfinder® Scott®6021™; Monarch Marking Systems; Portable Bar Code Printing; Scott It Out! Advertisement.

\* cited by examiner

*Primary Examiner*—Charles A. Rademaker

(74) *Attorney, Agent, or Firm*—Joseph J. Grass

(57) **CLAIM**

The ornamental design for a hand-held printer, as shown and described.

**DESCRIPTION**

FIG. 1 is a perspective view of a first embodiment of the invention;

FIGS. 2 through 7 are, respectively, left side, right side, rear, front, top and bottom views of the first embodiment also shown in FIG. 1;

FIG. 8 is a perspective view of a second embodiment of the invention, wherein the design includes contrasting areas, and wherein the contrasting areas are color-contrasting areas, or light and dark areas, or are both color-contrasting and light and dark; and,

FIGS. 9 through 14 are, respectively, left side, right side, rear, front, top and bottom views of the second embodiment also shown in FIG. 8.

**1 Claim, 14 Drawing Sheets**

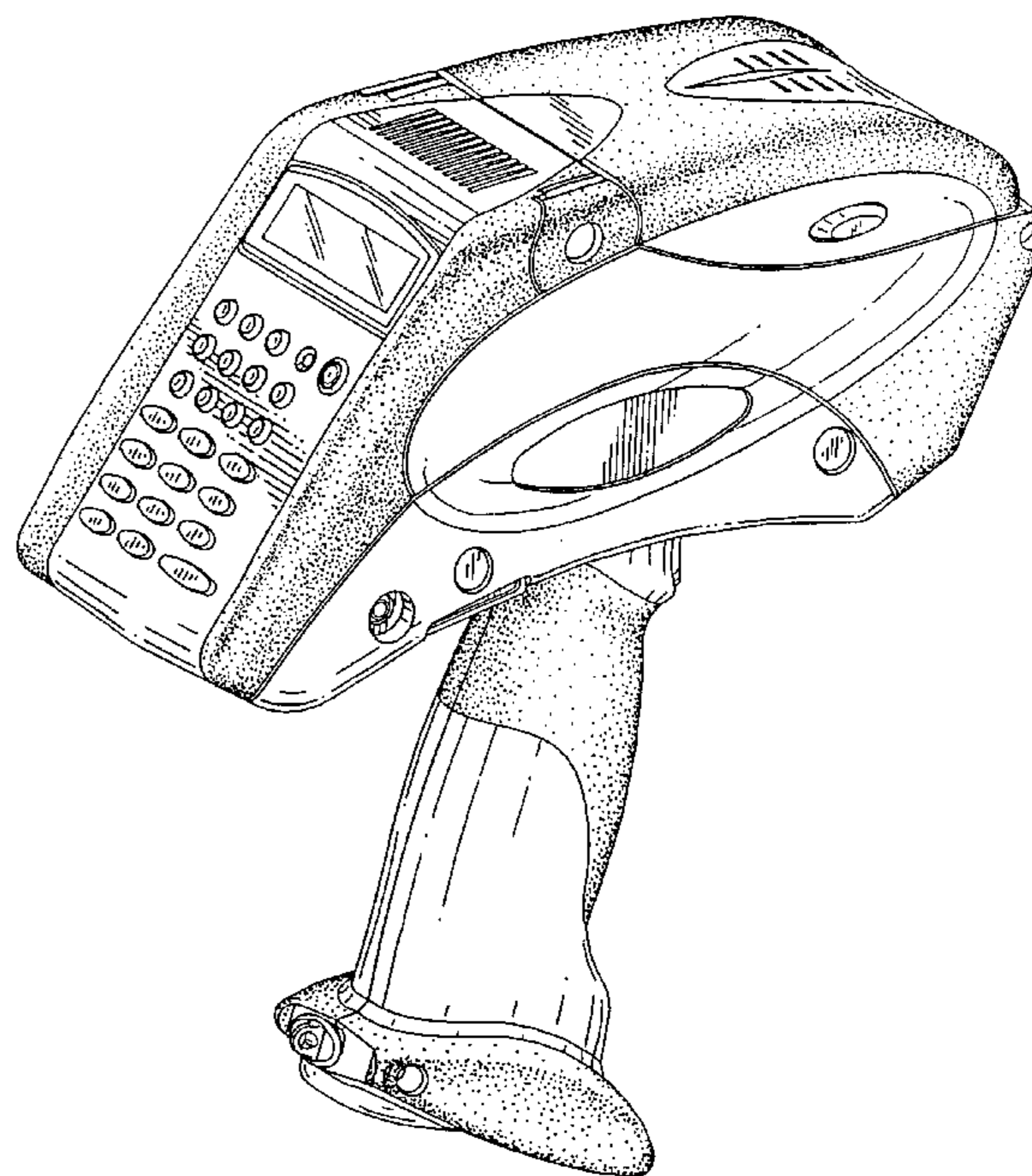
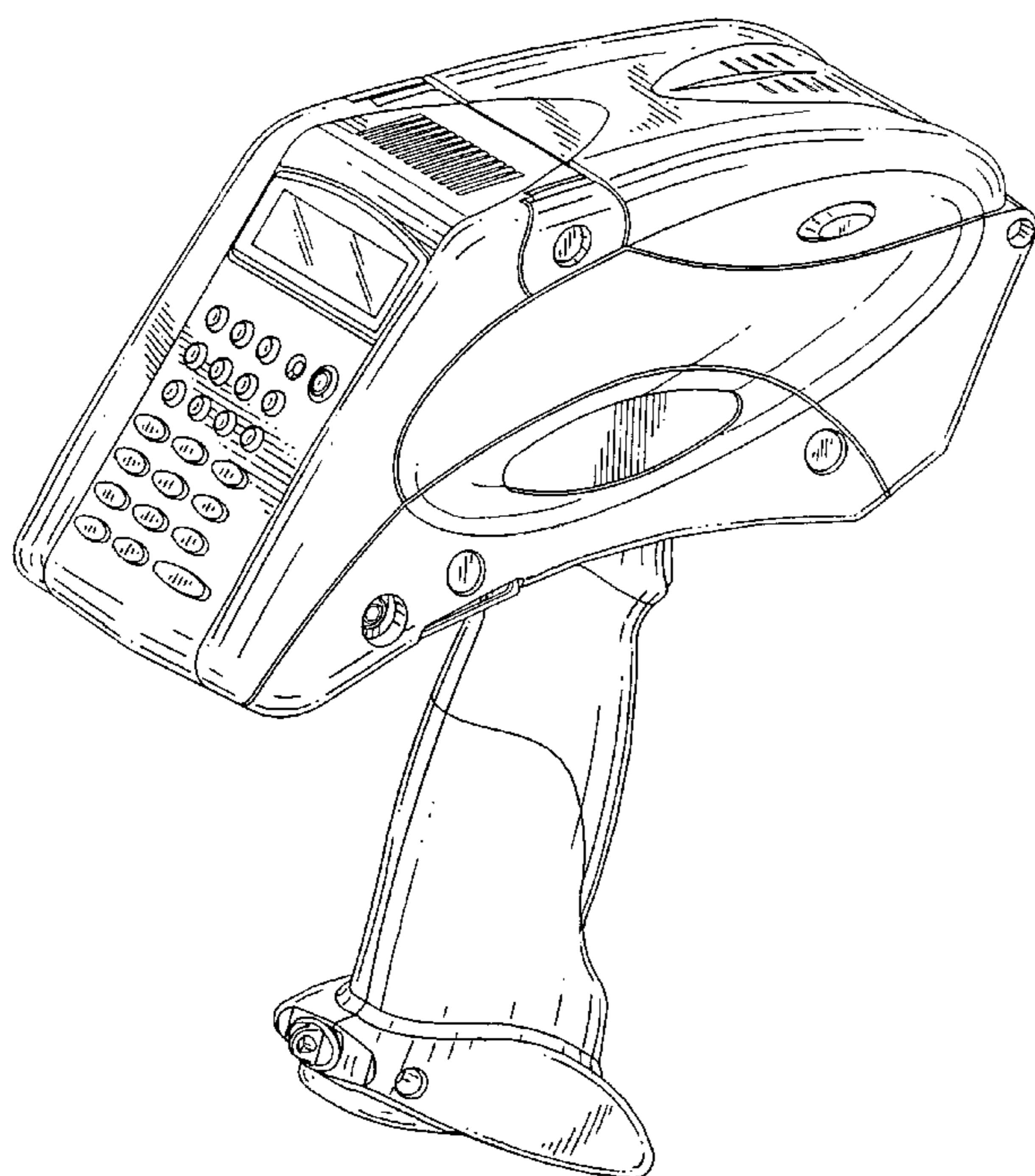

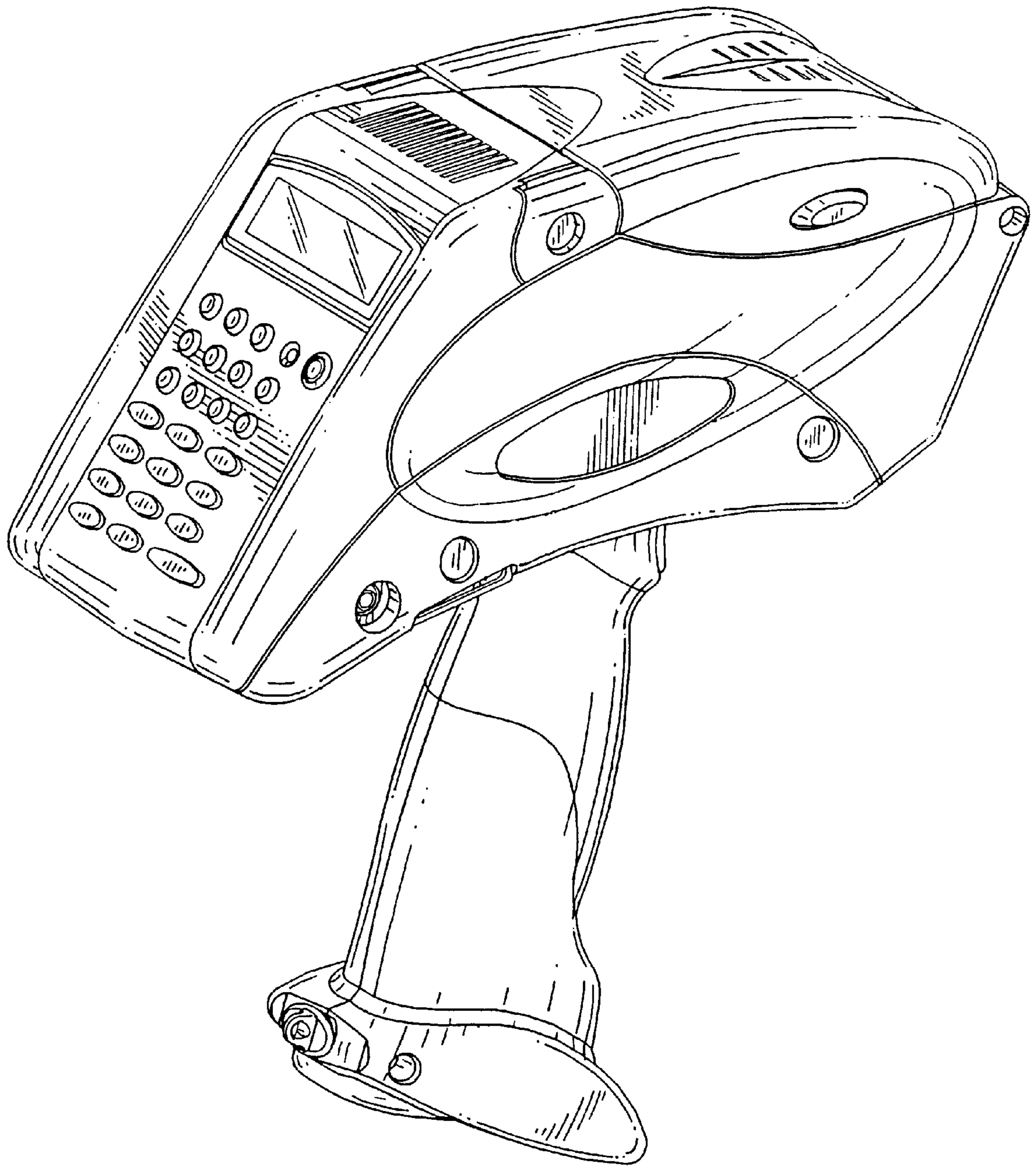

FIG. 1

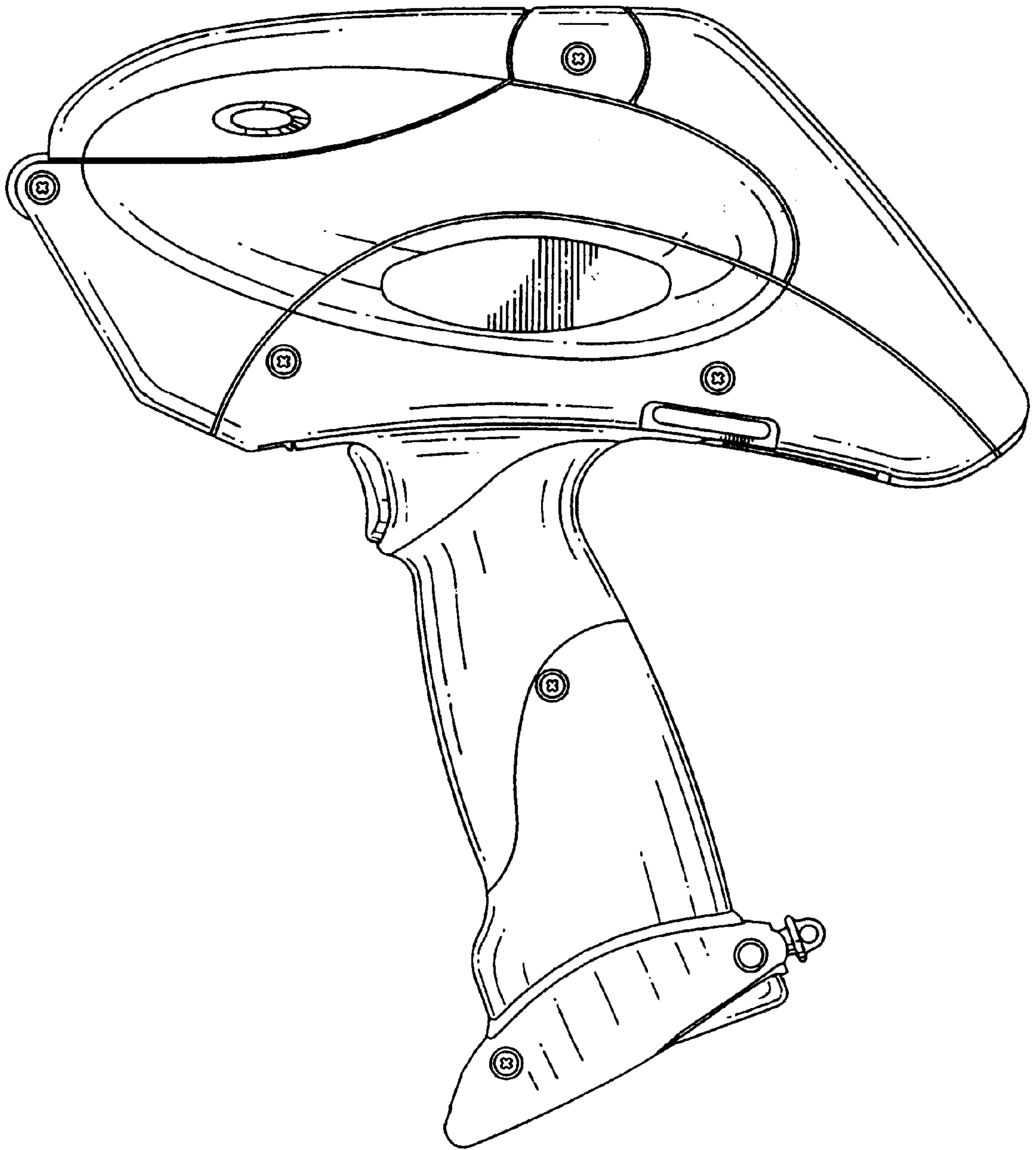

FIG.2

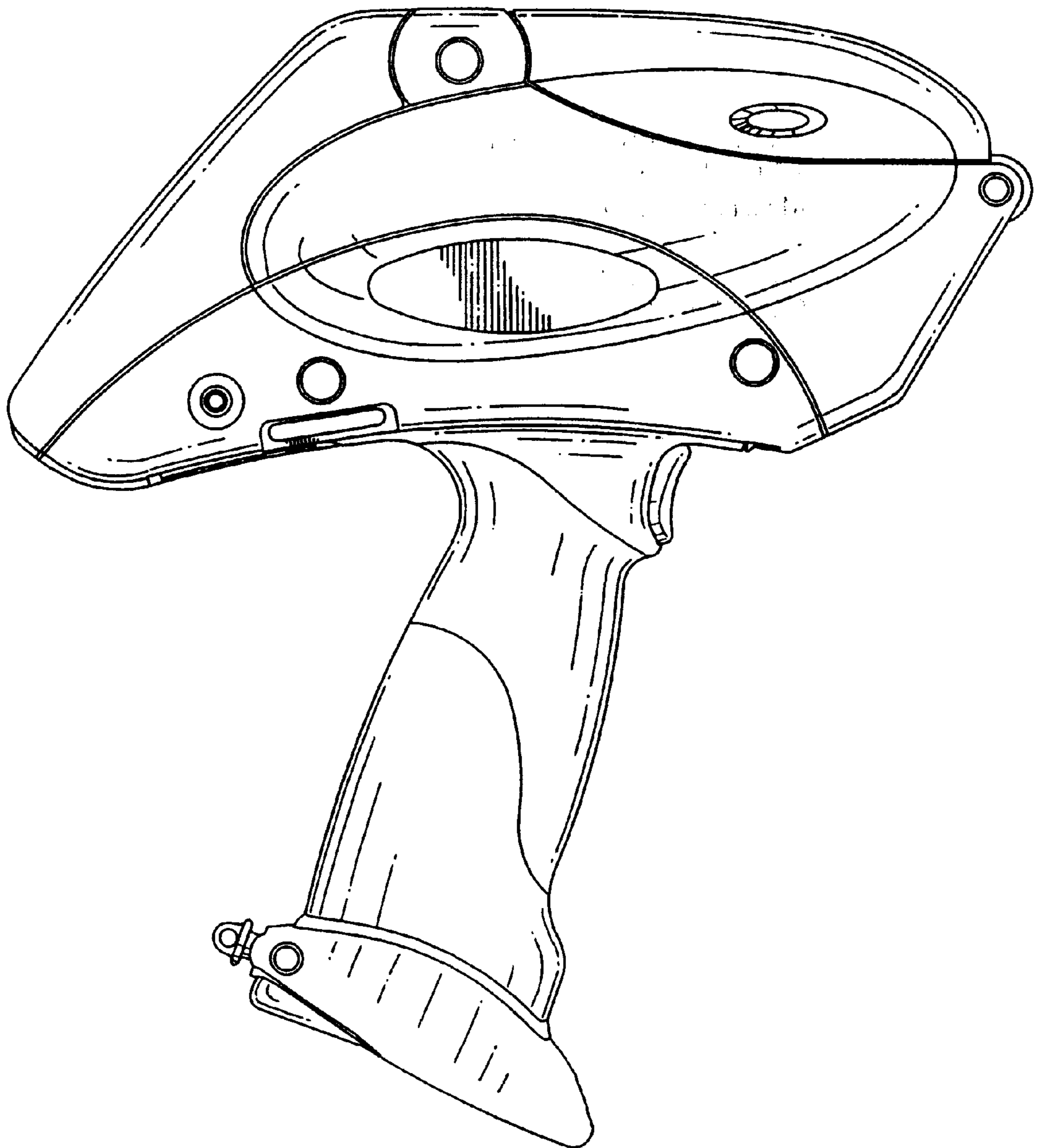

FIG.3

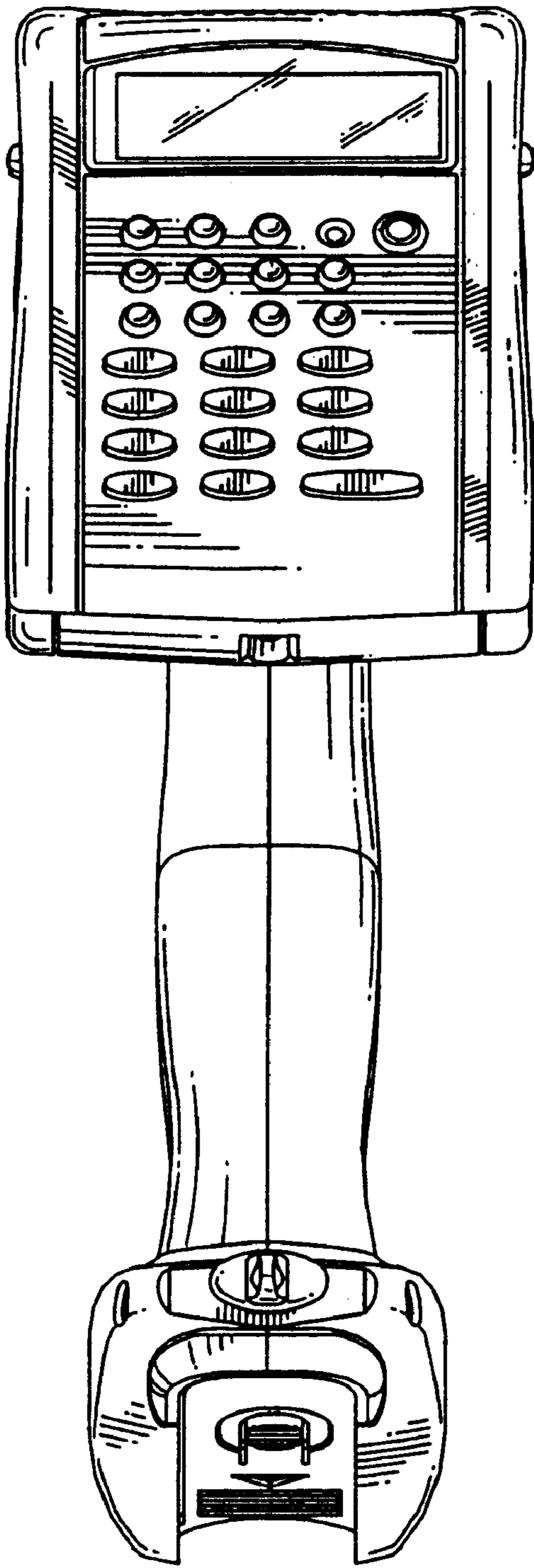

FIG. 4

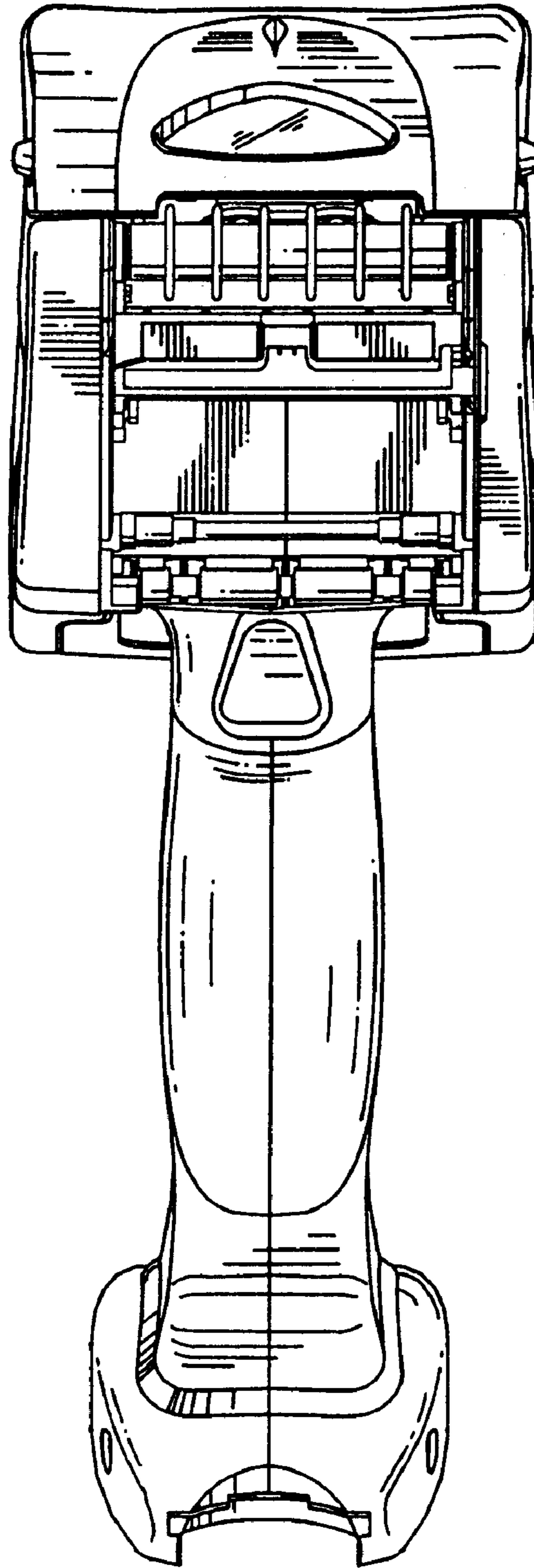

FIG.5

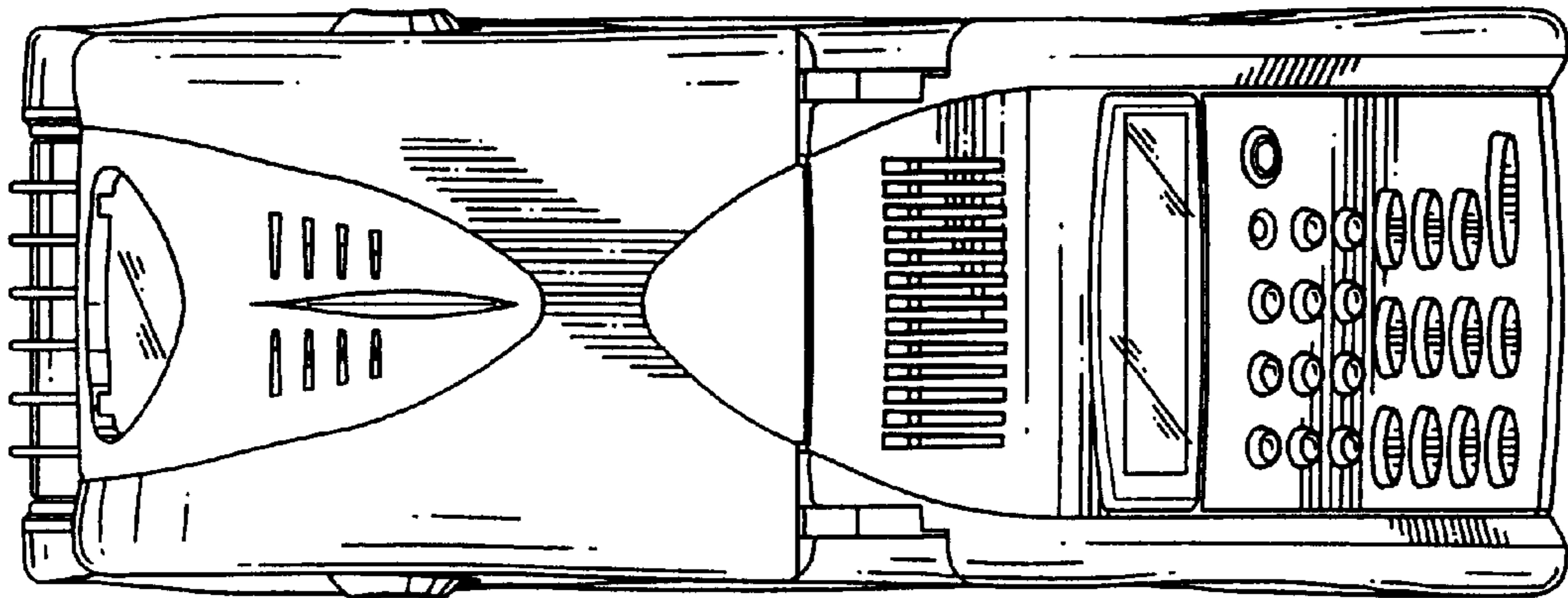

FIG.6

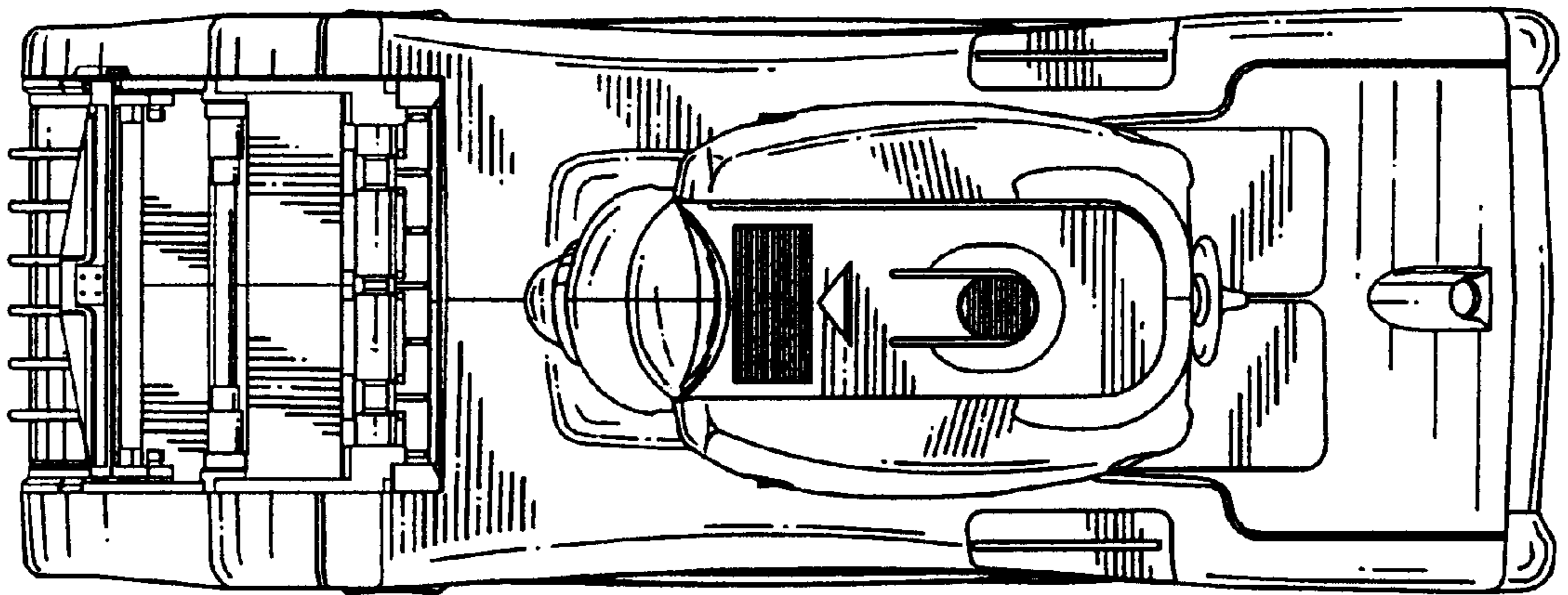

FIG.7



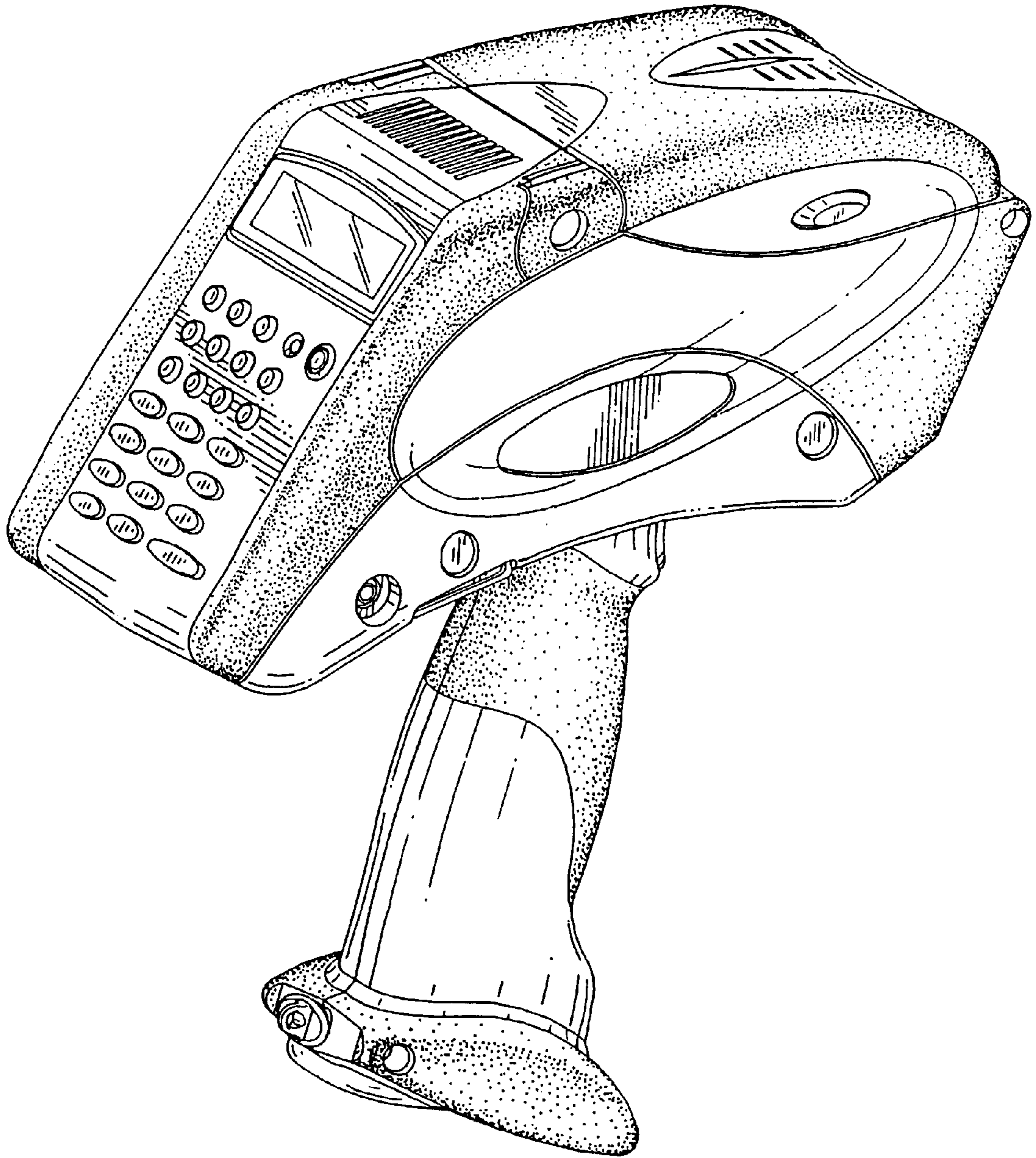

FIG.8

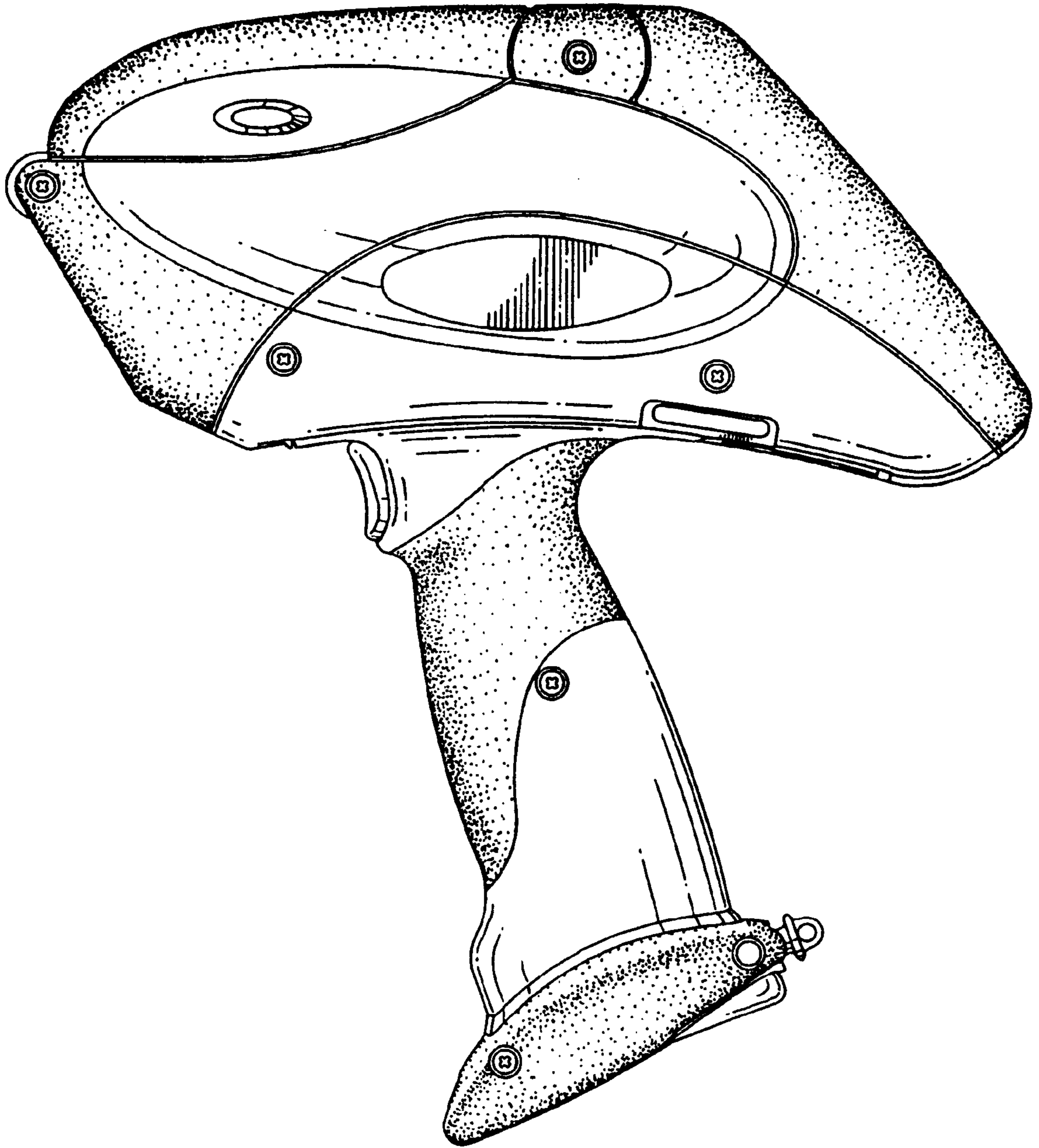

FIG.9

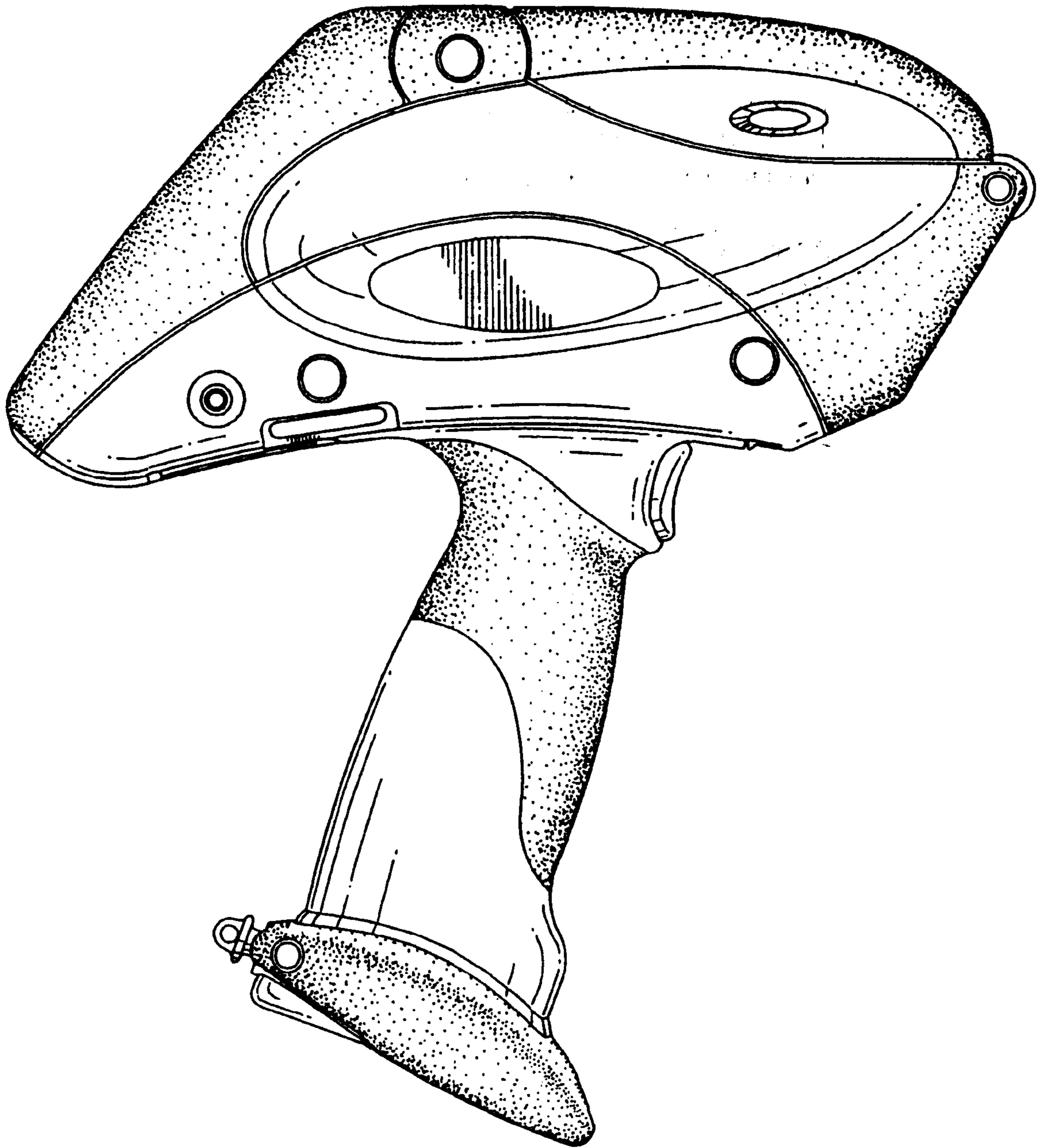

FIG. 10

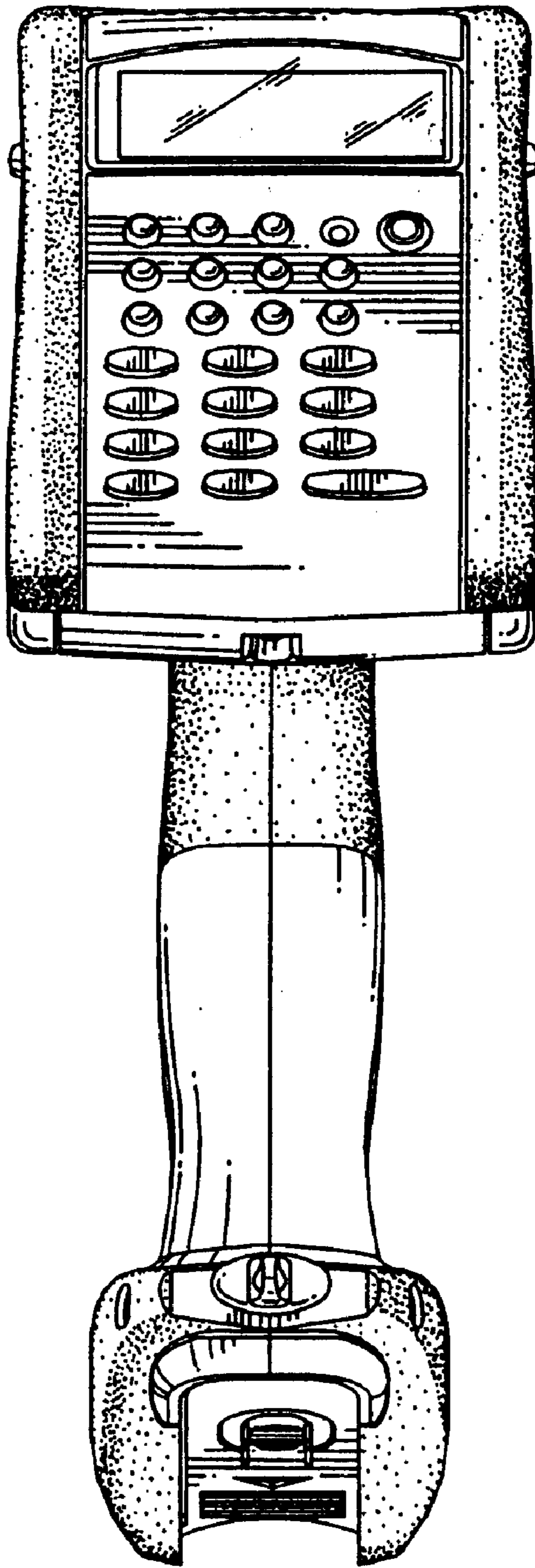

FIG. 11

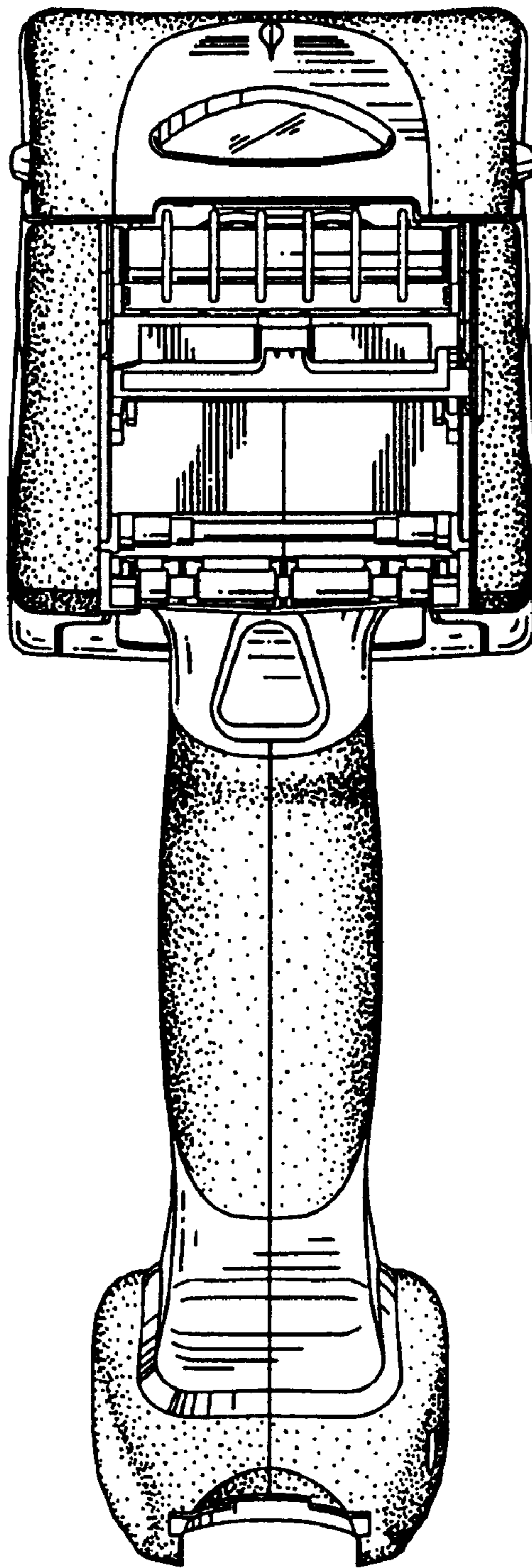

FIG.12

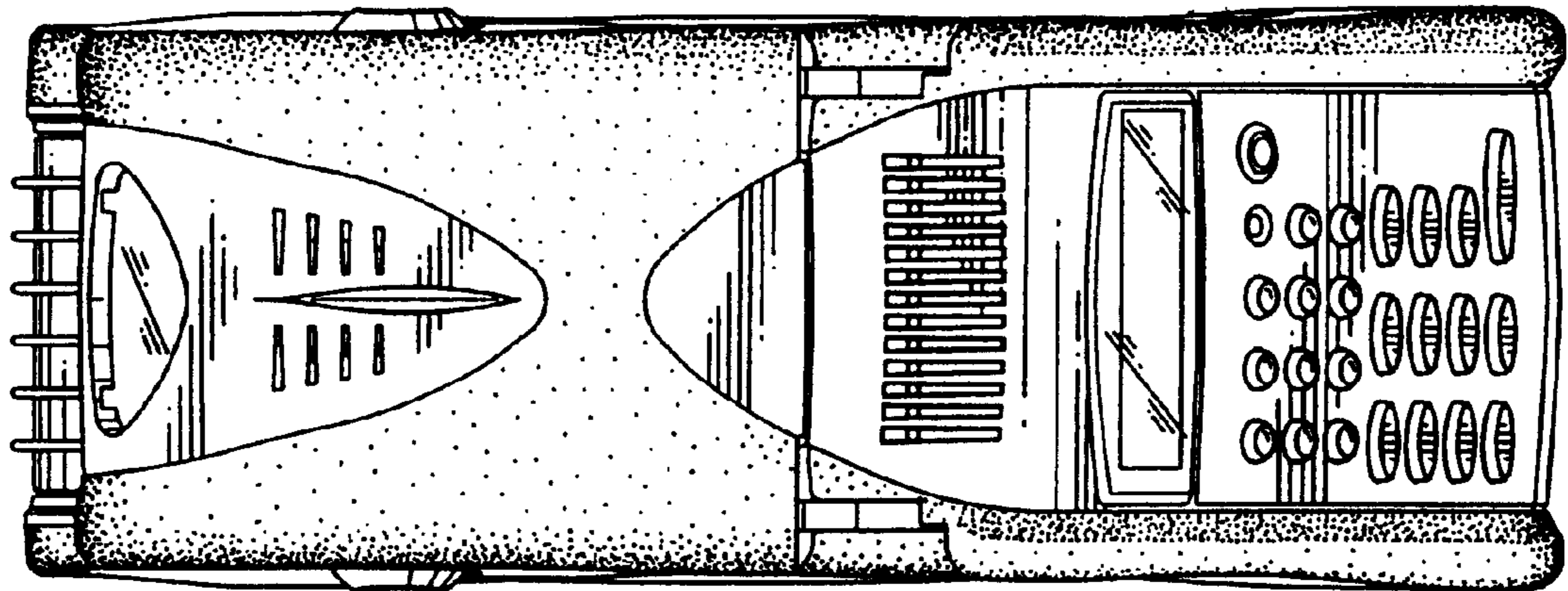

FIG.13

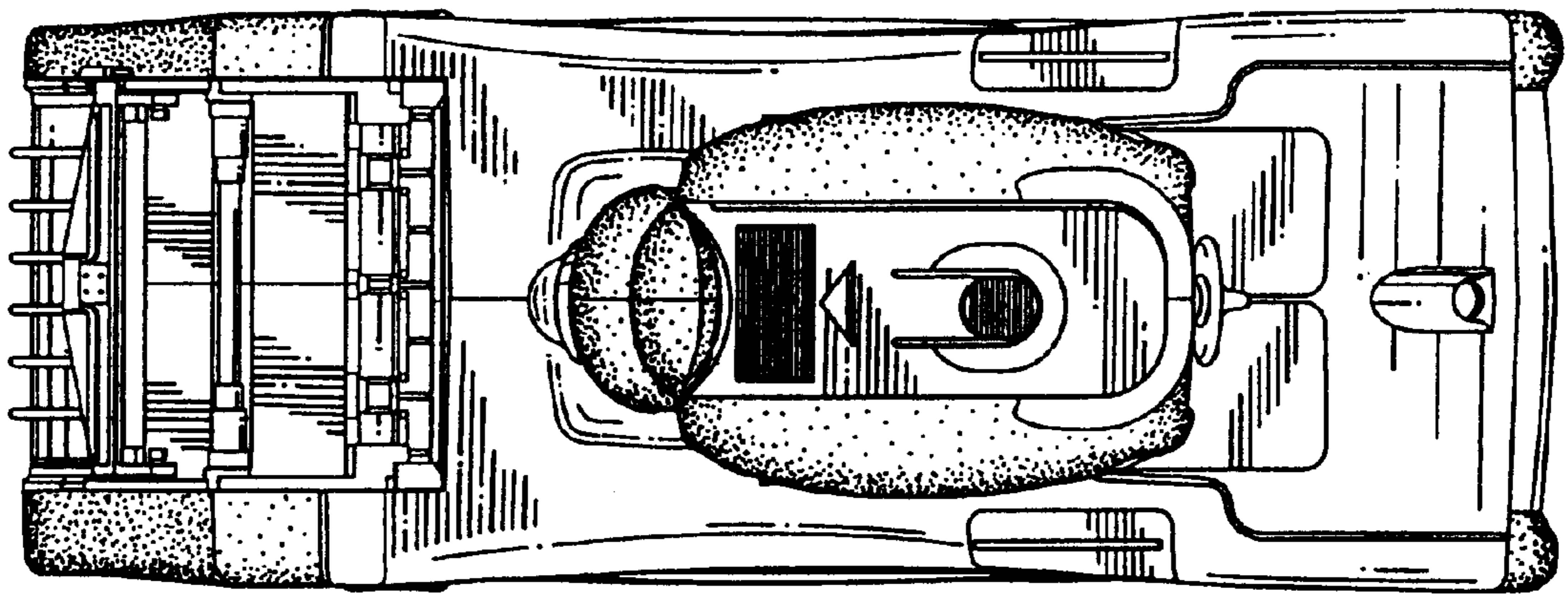

FIG.14