



US00D486453S

(12) **United States Design Patent**
Prior, Jr.

(10) **Patent No.:** **US D486,453 S**

(45) **Date of Patent:** **** Feb. 10, 2004**

(54) **PLUG CONNECTION COVER**

Primary Examiner—Joel Sincavage

(76) **Inventor:** **Arthur G. Prior, Jr.**, 449 Grove St.,
Mundelein, IL (US) 60060

(57) **CLAIM**

(**) **Term:** **14 Years**

The ornamental design for a plug connection cover, as shown and described.

(21) **Appl. No.:** **29/176,513**

DESCRIPTION

(22) **Filed:** **Feb. 24, 2003**

(51) **LOC (7) Cl.** **13-02**

(52) **U.S. Cl.** **D13/156**

(58) **Field of Search** D13/154, 156;
439/133, 367, 369

FIG. 1 is a front elevated view of a plug connection cover showing my new design.

FIG. 2 is a rear elevated view of the plug connection cover.

FIG. 3 is a side elevated view of the plug connection cover.

FIG. 4 is a top plan view of the plug connection cover.

FIG. 5 is a bottom plan view of the plug connection cover; and,

FIG. 6 is a perspective view of the plug connection cover.

The broken lines showing the cable throughout the drawing figures are included for the purpose of illustrating environmental structure only and form no part of the claimed design.

(56) **References Cited**

U.S. PATENT DOCUMENTS

D318,268 S	*	7/1991	Oikawa et al.	D13/156
5,185,691 A	*	2/1993	Korinsky	361/720
D419,526 S	*	1/2000	Hardi-Haasz	D13/154
6,099,340 A	*	8/2000	Florentine	439/367
D432,092 S	*	10/2000	Stebbleton et al.	D13/156
D469,410 S	*	1/2003	Lyon	D13/156

* cited by examiner

1 Claim, 2 Drawing Sheets

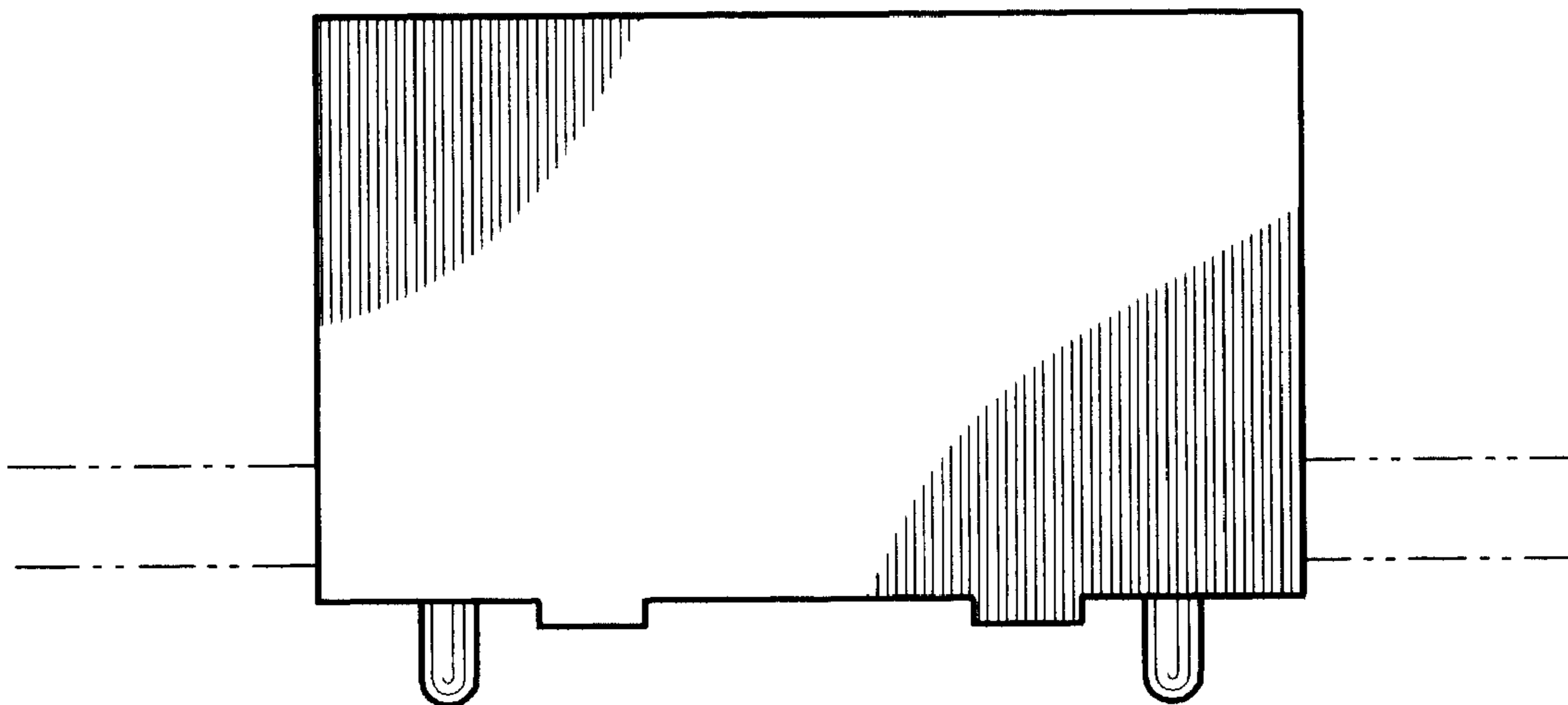

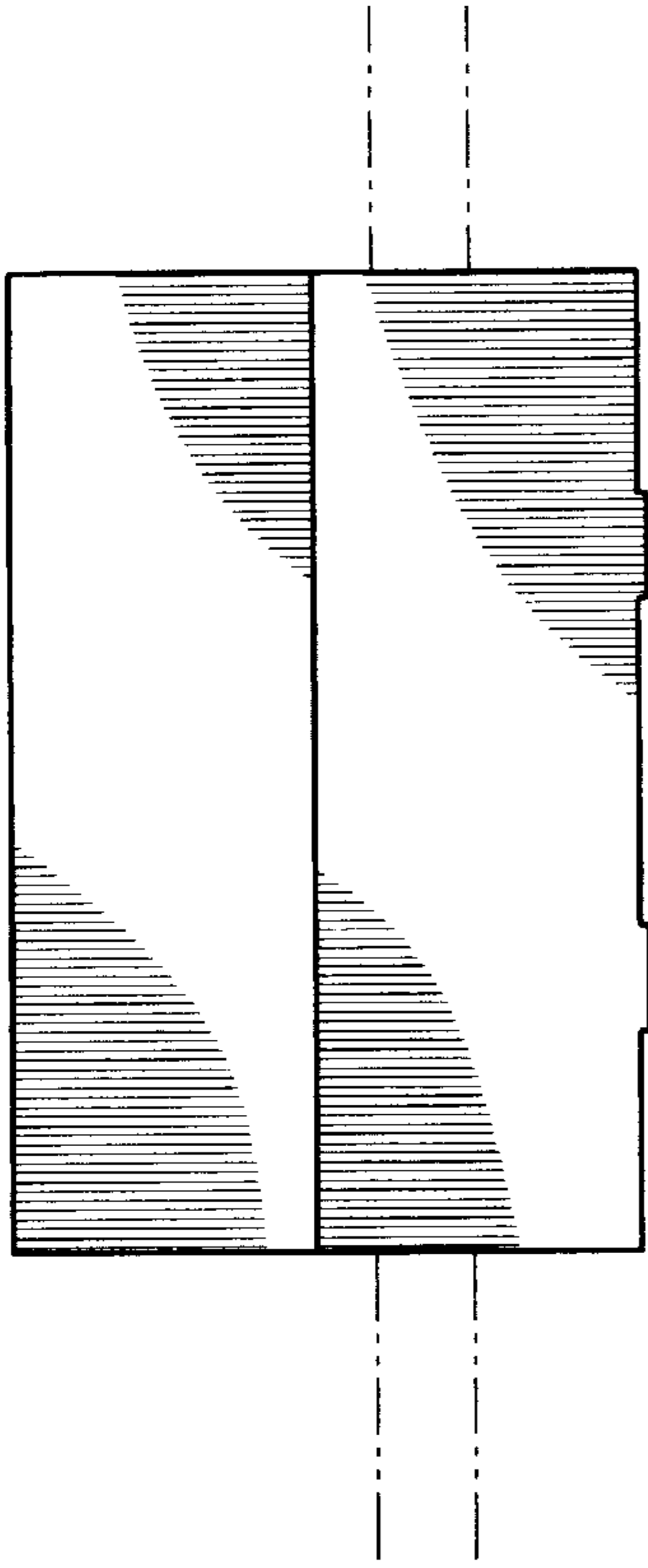

FIG. 4

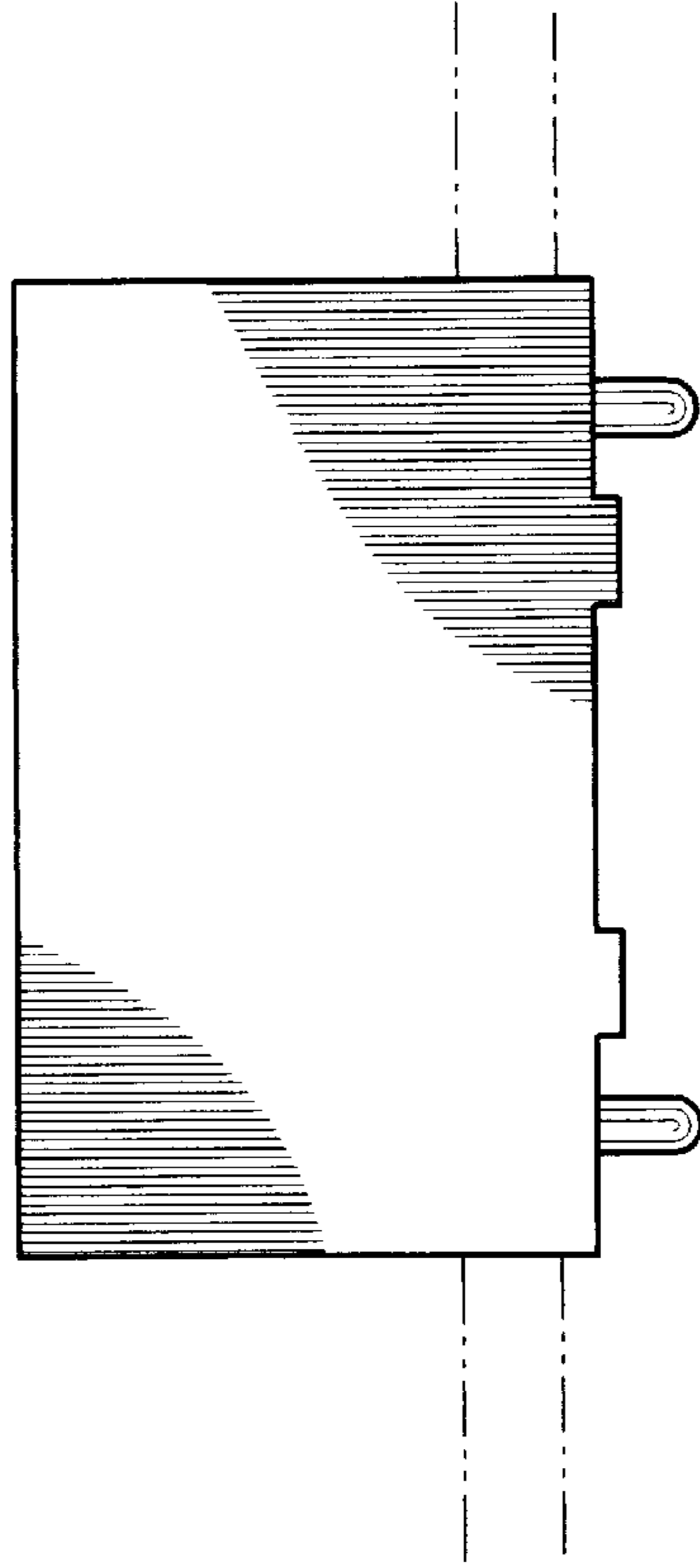

FIG. 1

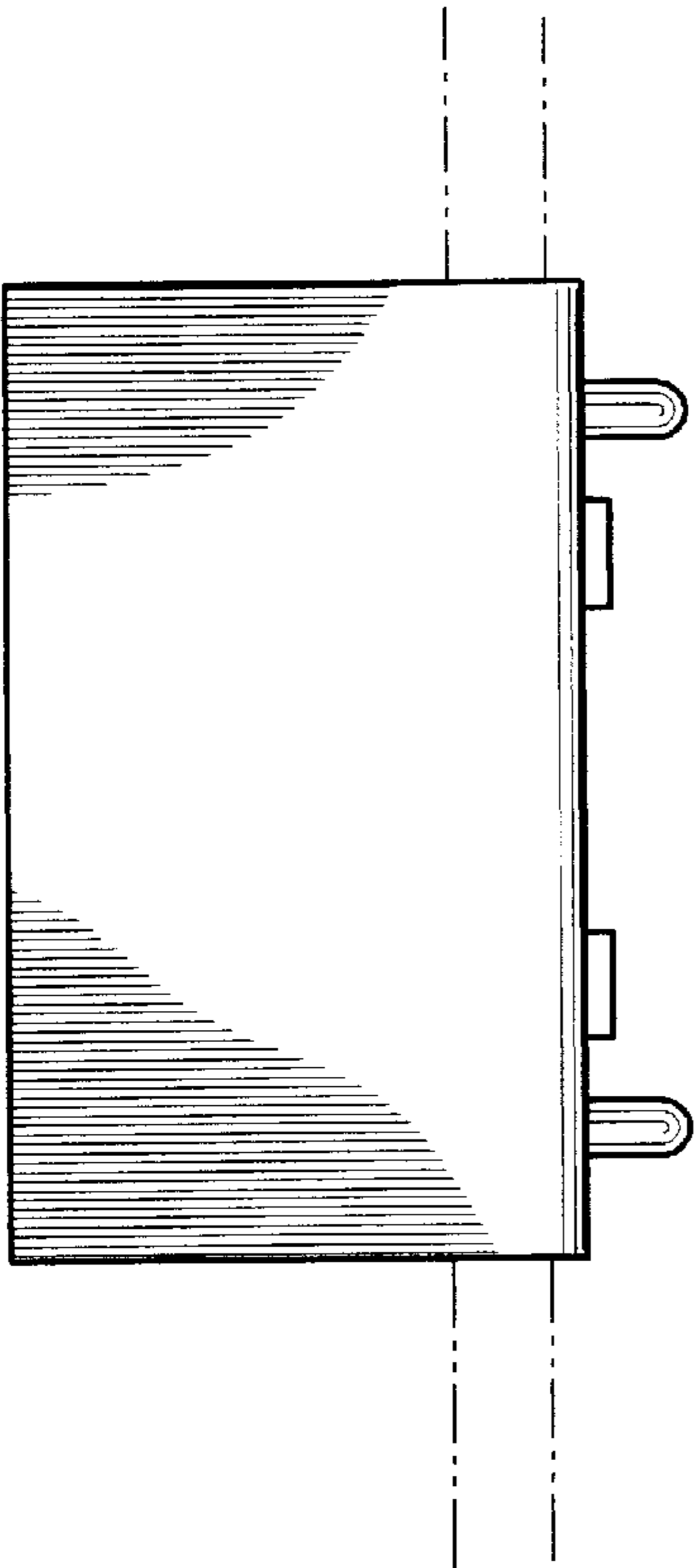

FIG. 2

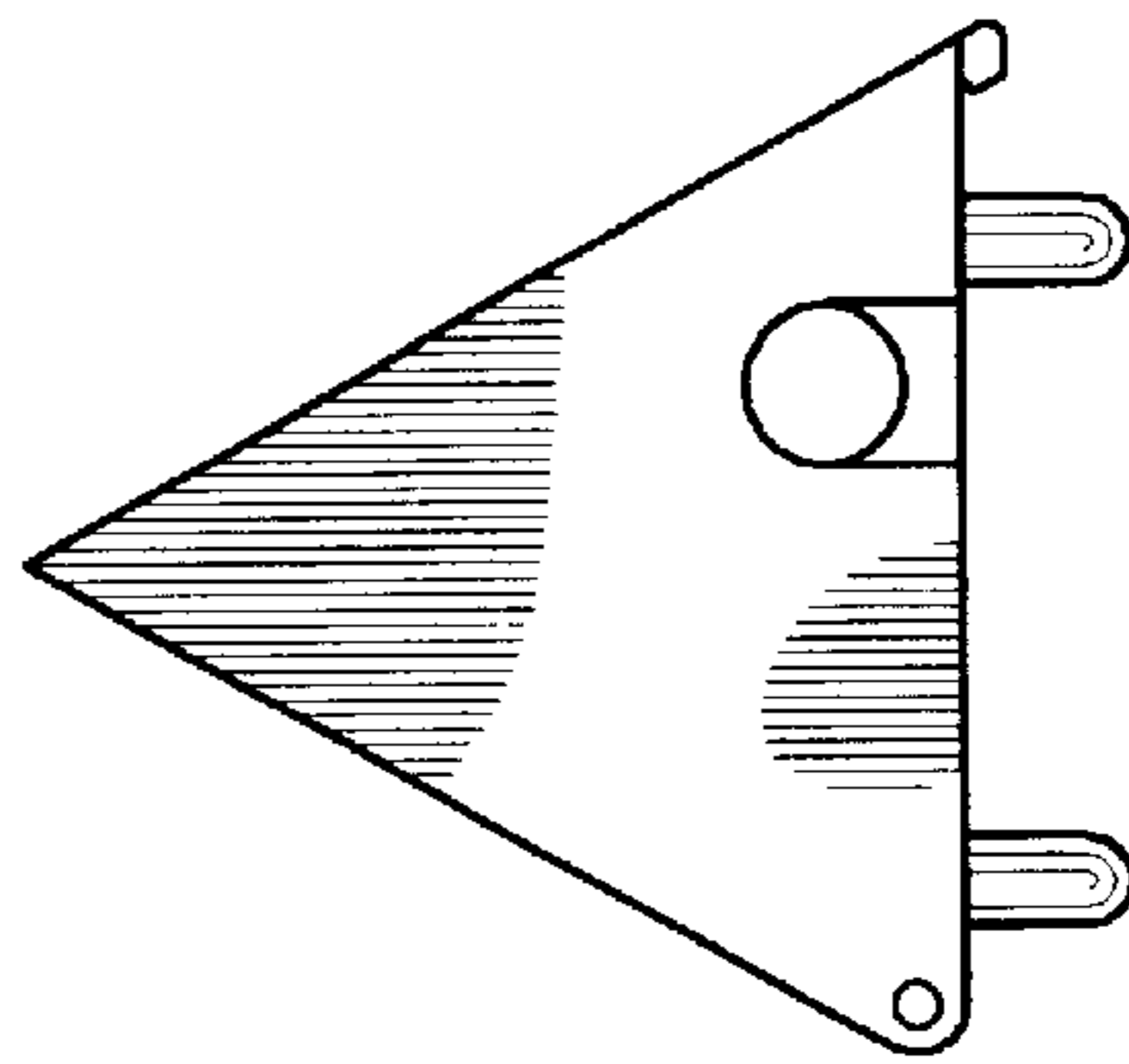

FIG. 3

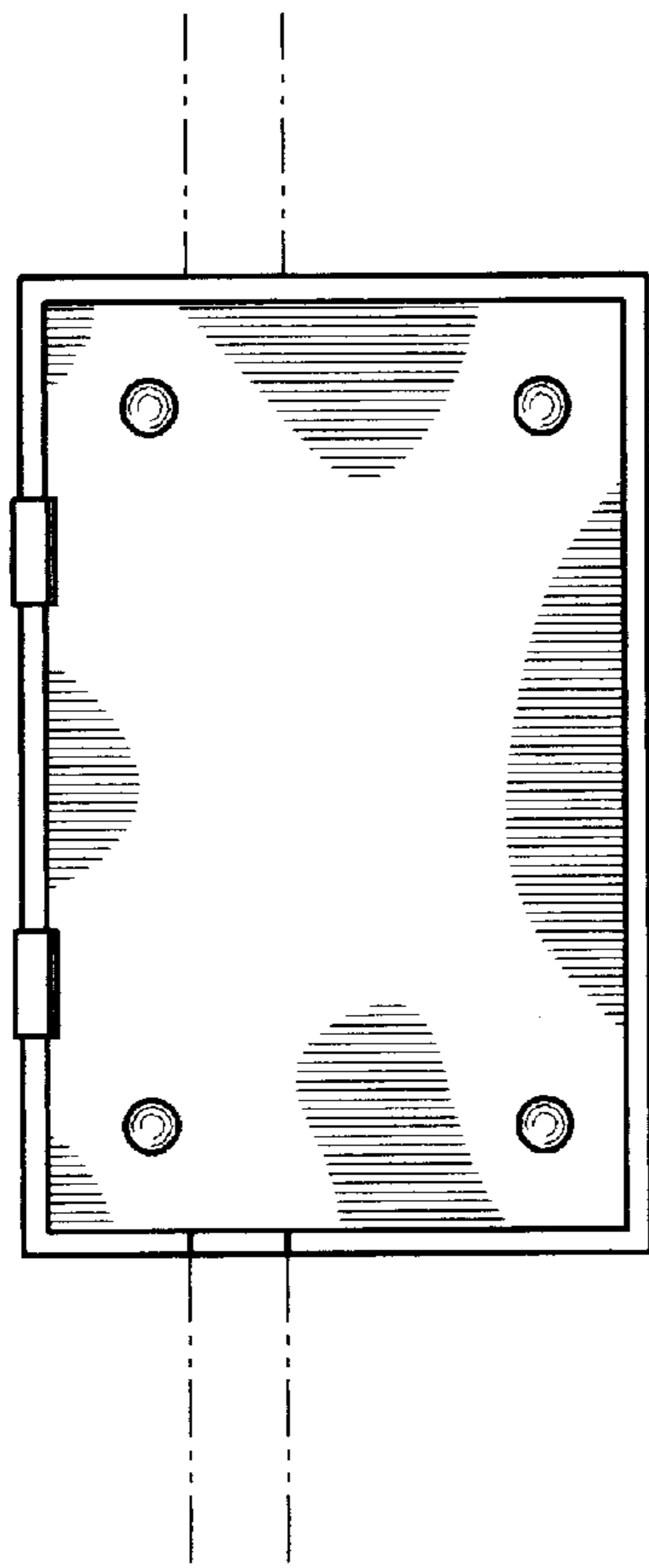

FIG. 5

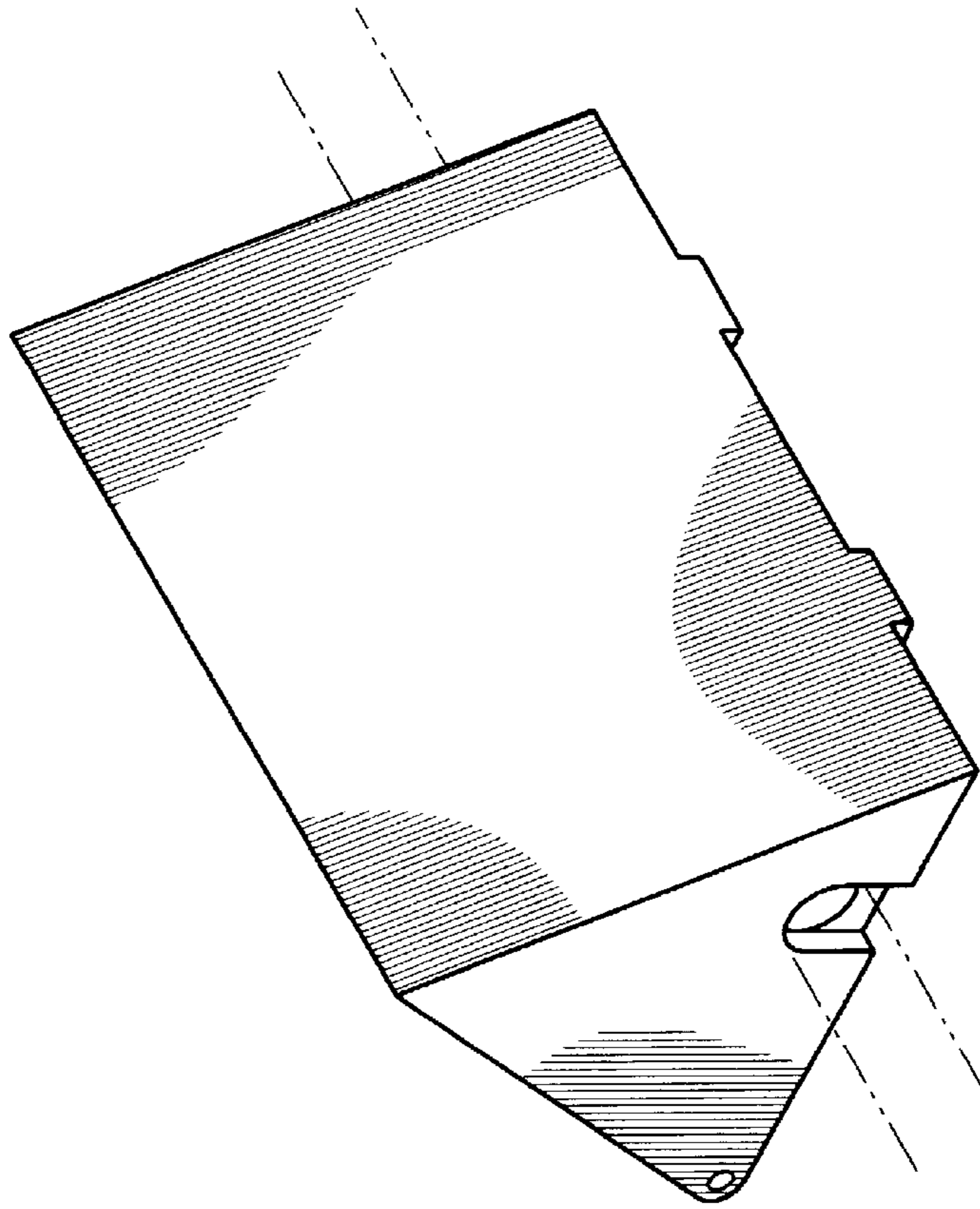

FIG. 6