



US00D486402S

(12) **United States Design Patent**  
**Shoubayashi**

(10) **Patent No.:** **US D486,402 S**

(45) **Date of Patent:** **\*\* Feb. 10, 2004**

(54) **WATCH CASE**

(75) **Inventor:** **Seiji Shoubayashi, Tachikawa (JP)**

(73) **Assignee:** **Casio Keisanki Kabushiki Kaisha, Tokyo (JP)**

(\*\*) **Term:** **14 Years**

(21) **Appl. No.:** **29/182,263**

(22) **Filed:** **May 22, 2003**

(51) **LOC (7) Cl. .... 10-02**

(52) **U.S. Cl. .... D10/30**

(58) **Field of Search .... D10/1-40, 122-132; 368/280-282, 276-277, 285, 294-295**

(56) **References Cited**

**U.S. PATENT DOCUMENTS**

- D442,500 S \* 5/2001 Moriai ..... D10/30
- D456,276 S \* 4/2002 Shiraishi ..... D10/30
- D459,237 S \* 6/2002 Hasegawa ..... D10/30

- D462,622 S \* 9/2002 Sugisawa ..... D10/30
- D462,623 S \* 9/2002 Fujihara ..... D10/30
- D479,691 S \* 9/2003 Goto ..... D10/30

\* cited by examiner

*Primary Examiner*—Nelson C. Holtje

(74) *Attorney, Agent, or Firm*—Frishauf, Holtz, Goodman & Chick, P.C.

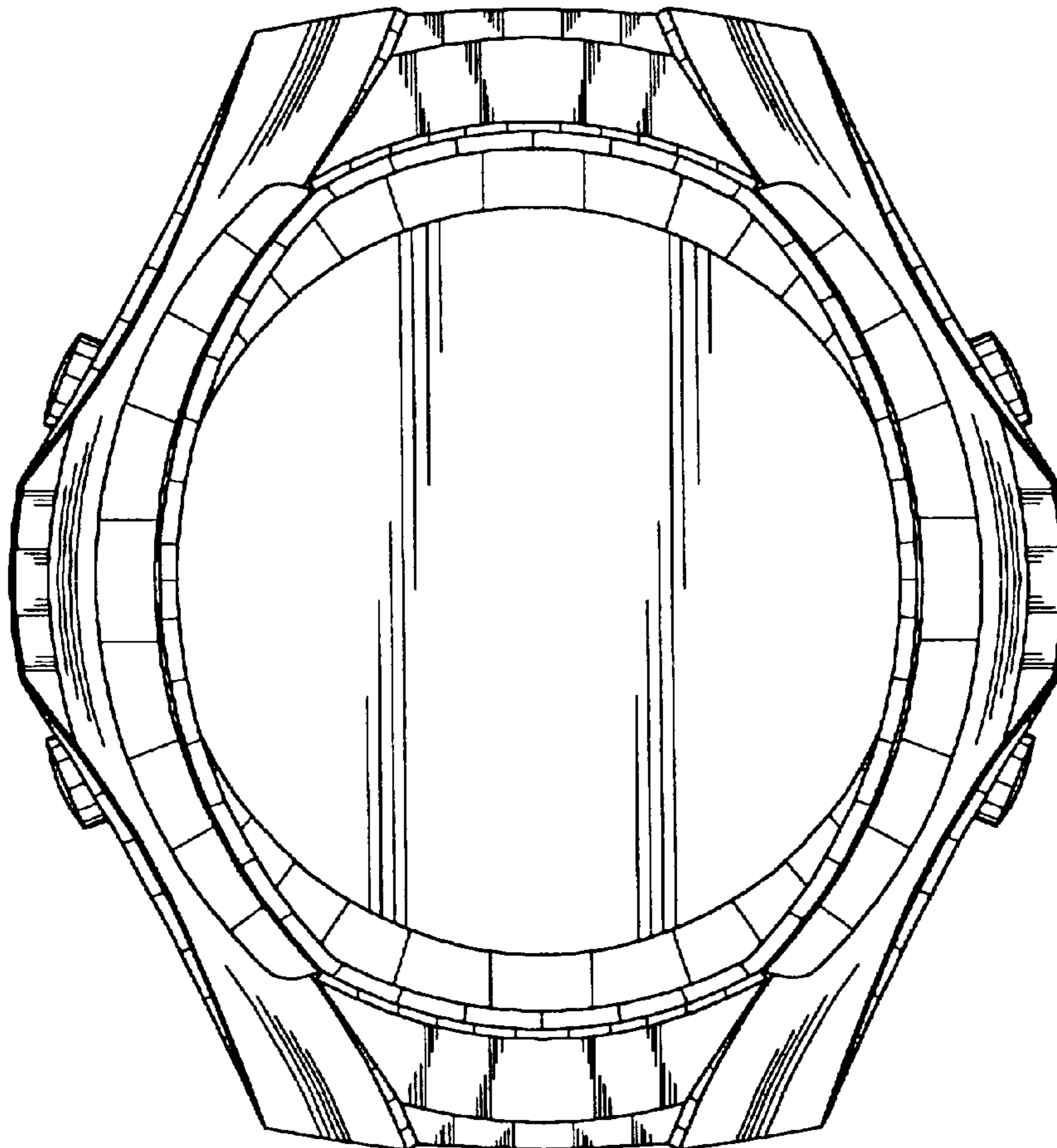
(57) **CLAIM**

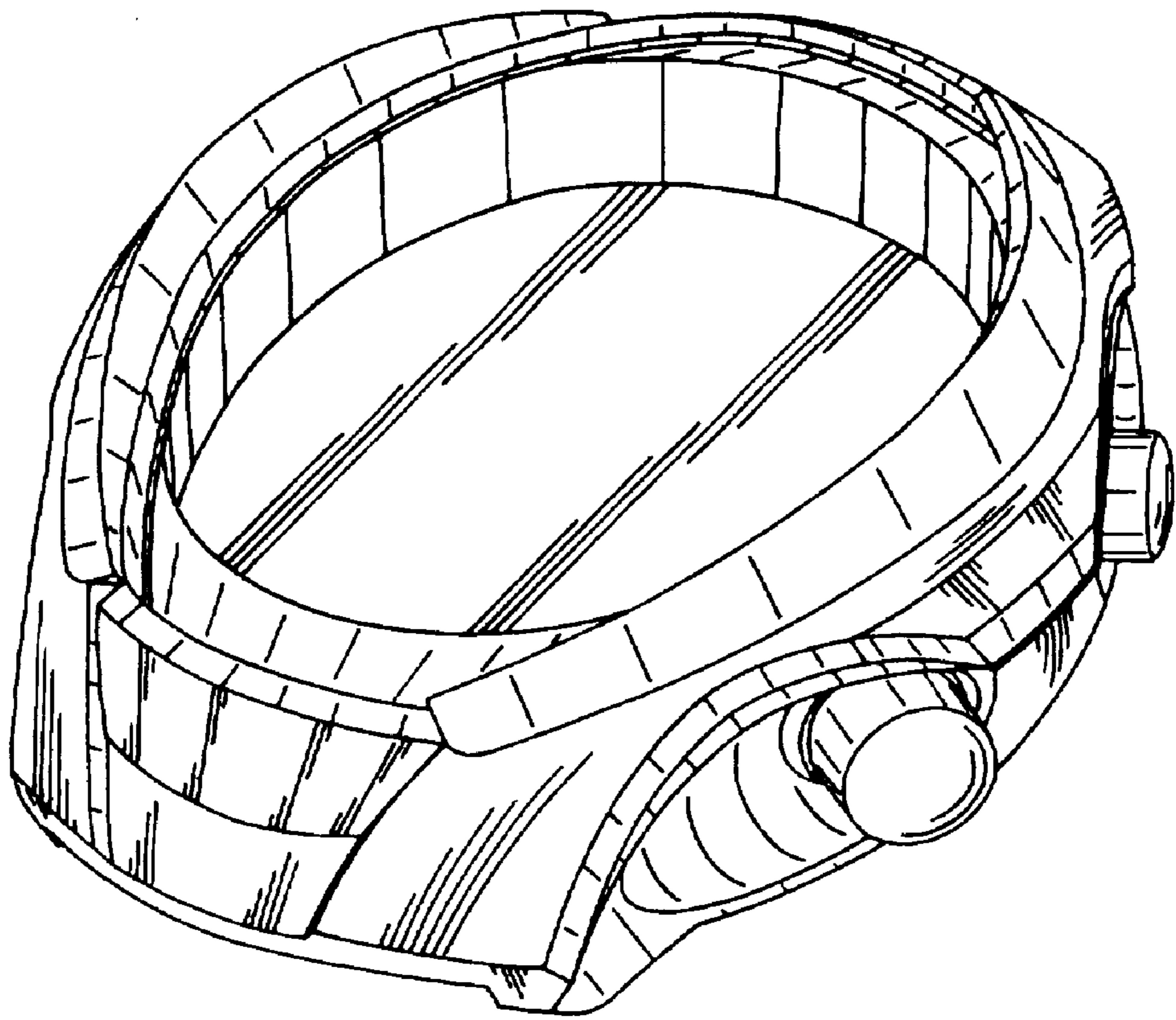
The ornamental design for watch case, as shown.

**DESCRIPTION**

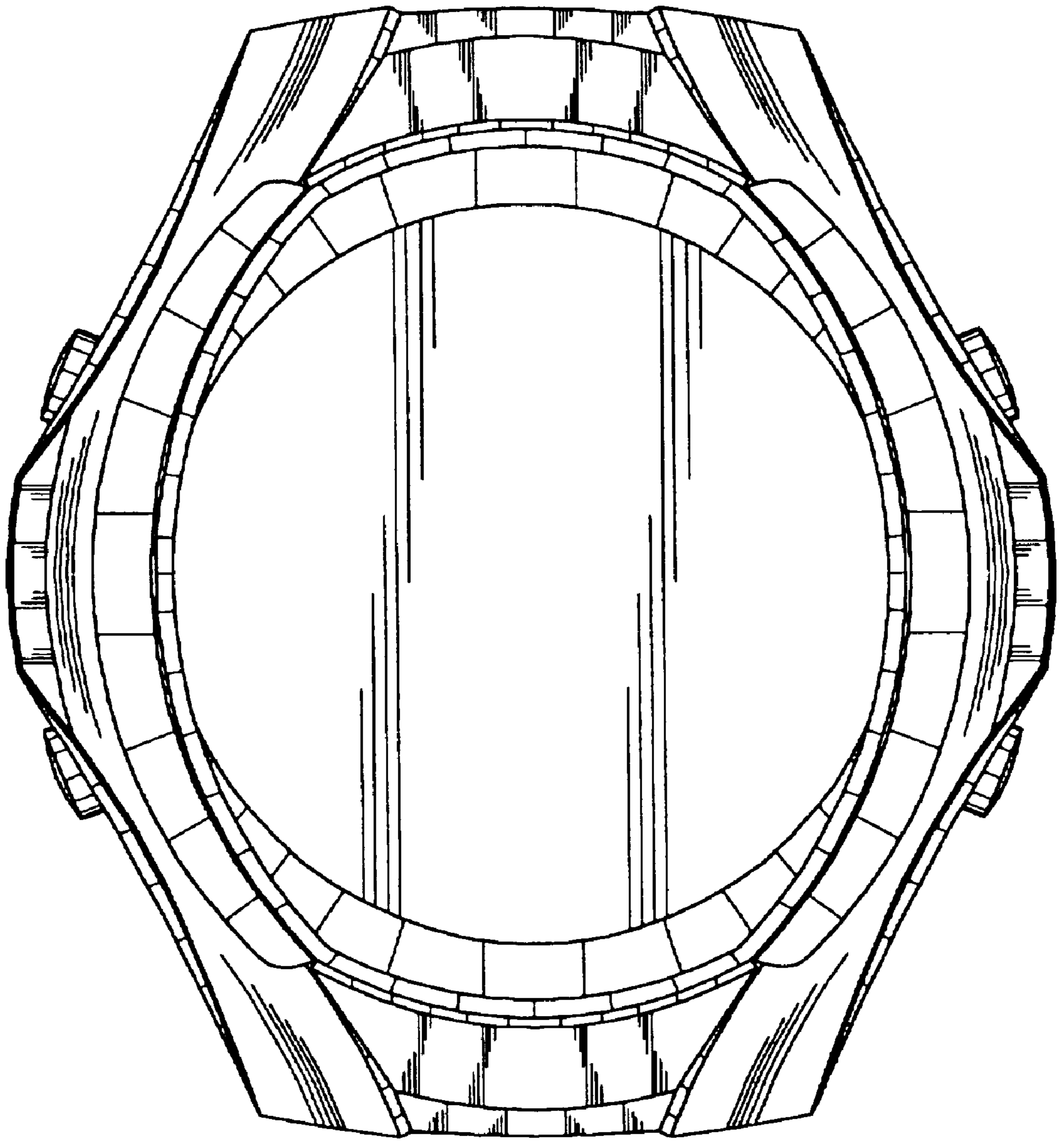
FIG. 1 is a front, right, bottom side perspective view of a watch case showing my new design;  
 FIG. 2 is a front elevational view thereof;  
 FIG. 3 is a rear elevational view thereof;  
 FIG. 4 is a left side view thereof;  
 FIG. 5 is a right side view thereof;  
 FIG. 6 is a top plan view thereof; and,  
 FIG. 7 is a bottom plan view thereof.

**1 Claim, 7 Drawing Sheets**

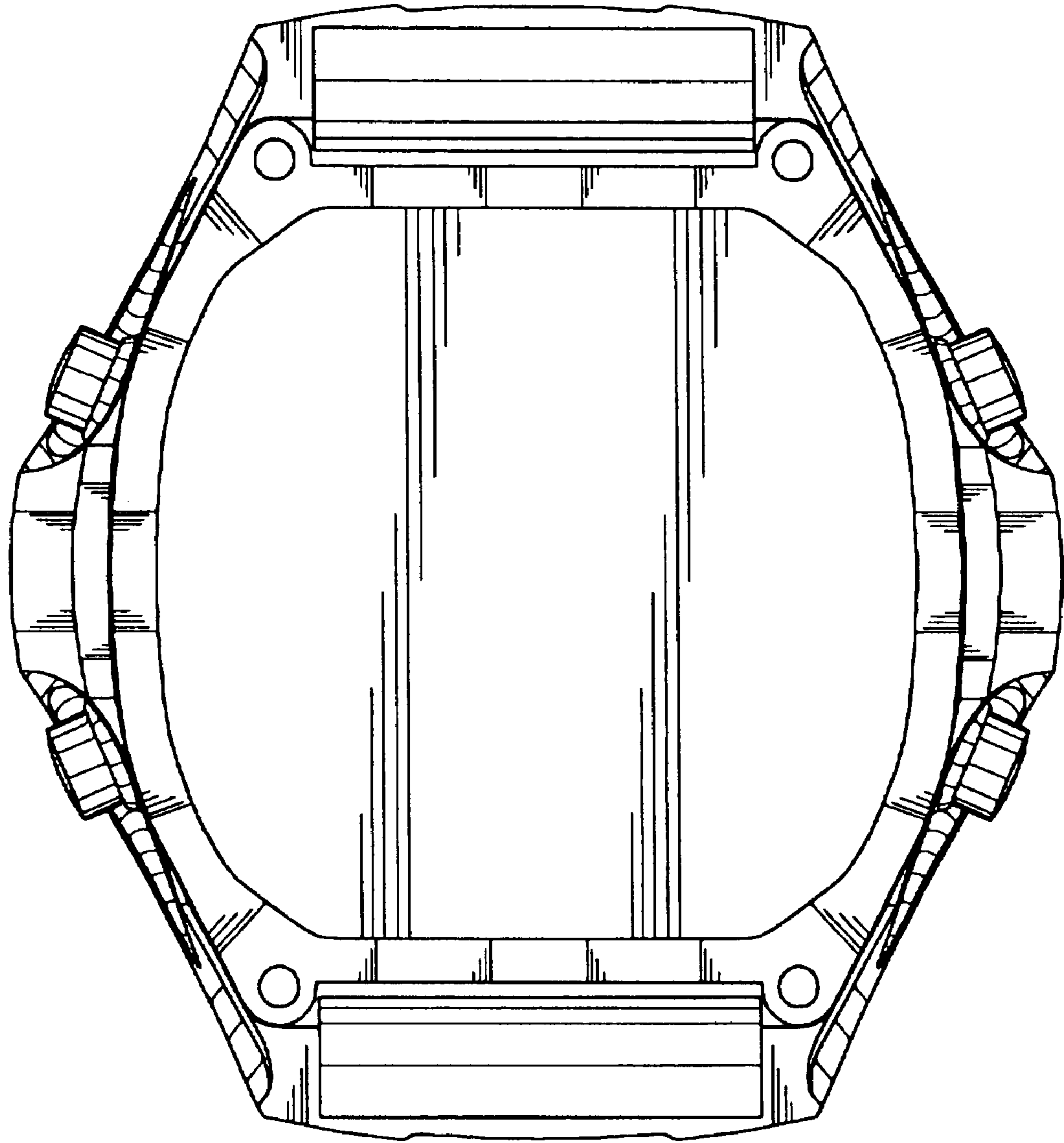




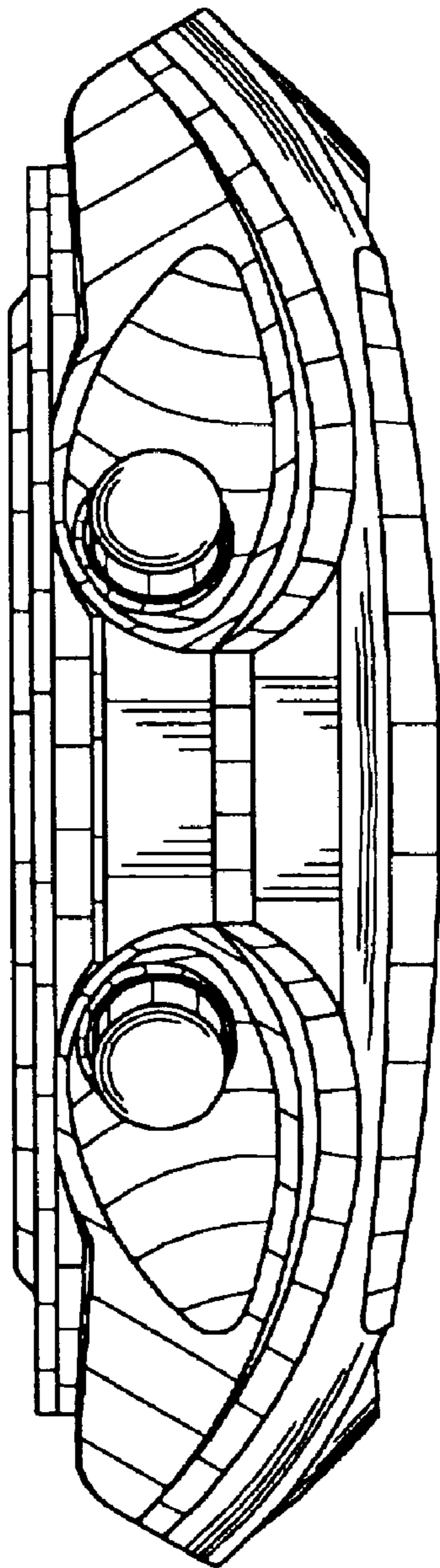
**FIG. 1**



**FIG. 2**

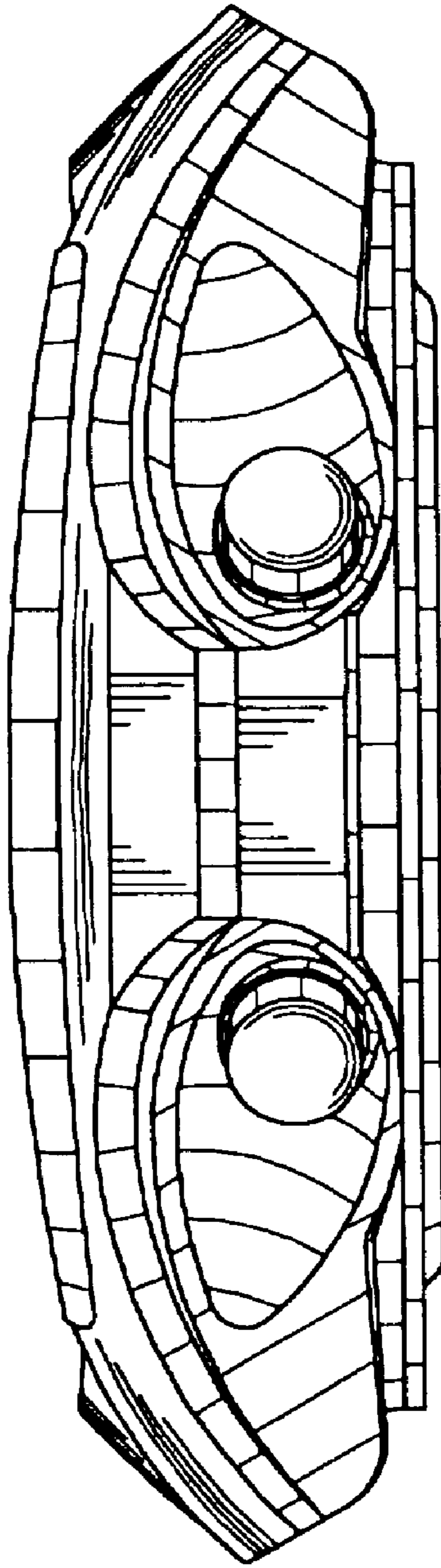


**FIG. 3**

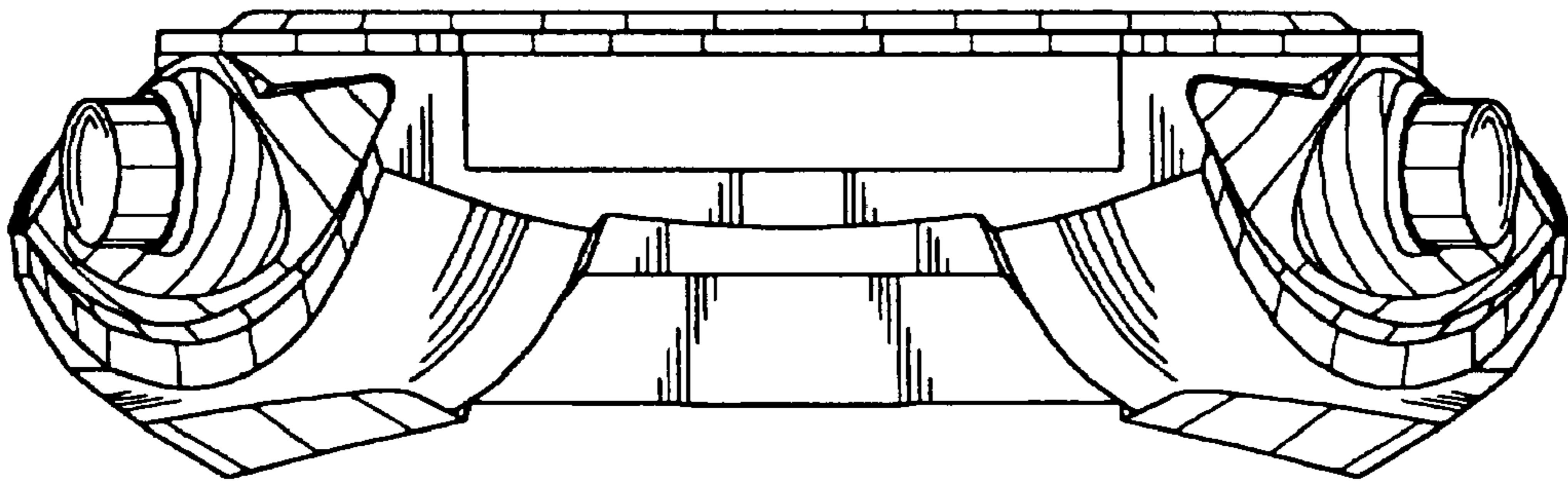


**FIG. 4**

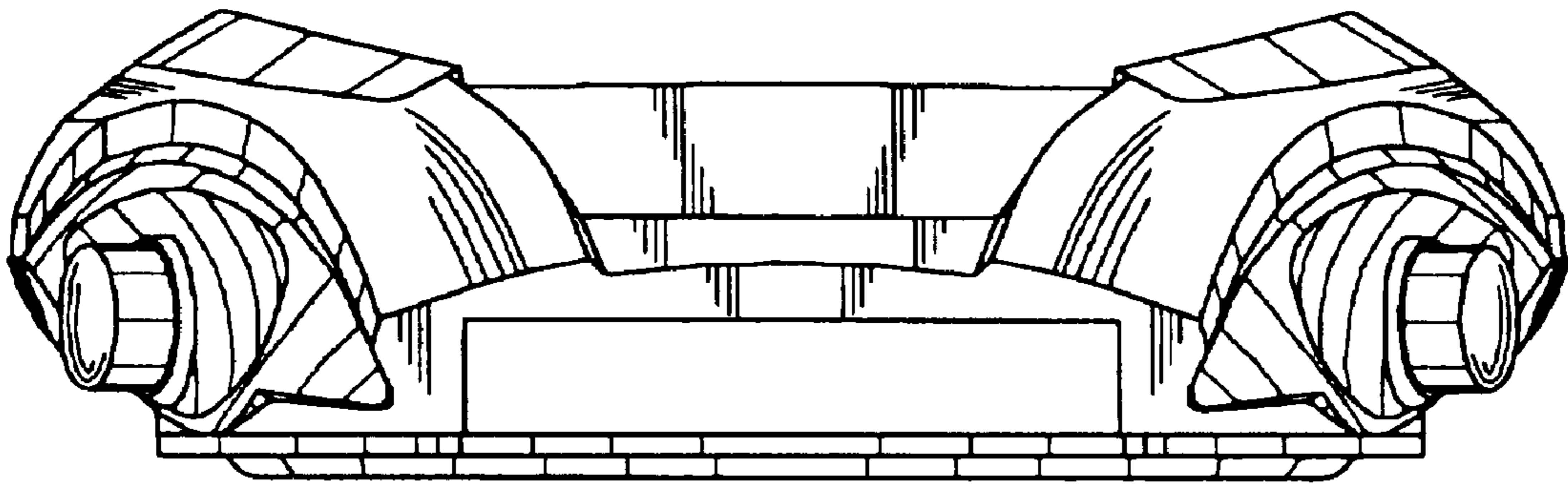




**FIG. 5**



**FIG. 6**



**FIG. 7**