



US00D486380S

(12) **United States Design Patent**
McDaniel

(10) **Patent No.:** **US D486,380 S**

(45) **Date of Patent:** **** Feb. 10, 2004**

(54) **WALL HANGING**

(76) **Inventor:** **Eilbert L. McDaniel**, 370 E. St. Clair St., Indianapolis, IN (US) 46202

(**) **Term:** **14 Years**

(21) **Appl. No.:** **29/174,866**

(22) **Filed:** **Jan. 27, 2003**

(51) **LOC (7) Cl.** **08-07**

(52) **U.S. Cl.** **D8/372**

(58) **Field of Search** D6/553, 567, 569, D6/572, 315, 320, 323, 327, 552; D8/349, 354, 367, 372; 211/13.1, 85.9, 30, 32, 34, 35, 86.01, 87.01; 248/309.1, 309.2

(56) **References Cited**

U.S. PATENT DOCUMENTS

D236,567 S	*	9/1975	Ballin	D6/323
D268,890 S	*	5/1983	Morin	D7/641
D275,629 S	*	9/1984	Einhorn	D8/372
D304,984 S	*	12/1989	French	D6/552
D387,569 S		12/1997	Goodman et al.		
D390,014 S		2/1998	Ho		
D397,152 S		8/1998	Weller		
D398,451 S		9/1998	Sharpe		
D409,398 S		5/1999	Sweetman		
D410,804 S		6/1999	Murray		
D423,339 S	*	4/2000	Snell	D8/372
D441,966 S		5/2001	Lai		
D444,958 S		7/2001	Lindberg		
D446,658 S		8/2001	Osborne		

D446,972 S	8/2001	Aguayo, Jr.
D456,150 S	4/2002	Moore
D459,200 S	6/2002	Zhao
D462,844 S	9/2002	Chou

* cited by examiner

Primary Examiner—Brian N. Vinson
(74) *Attorney, Agent, or Firm*—E. Victor Indiano; Indiano, Vaughan, Roberts & Filomena, P.A.

(57) **CLAIM**

The ornamental design for a wall hanging, as shown and described.

DESCRIPTION

FIG. 1 is a perspective view of a wall hanging showing my new design;
 FIG. 2 is a front view thereof;
 FIG. 3 is a right side view thereof;
 FIG. 4 is a left side view thereof;
 FIG. 5 is a rear view thereof;
 FIG. 6 is a top view thereof;
 FIG. 7 is a bottom view thereof;
 FIG. 8 is a perspective view showing an alternate embodiment of my wall hanging showing my new design;
 FIG. 9 is a front view thereof;
 FIG. 10 is a right side view thereof;
 FIG. 11 is a left side view thereof;
 FIG. 12 is a rear view thereof;
 FIG. 13 is a top view thereof; and,
 FIG. 14 is a bottom view thereof.

1 Claim, 6 Drawing Sheets

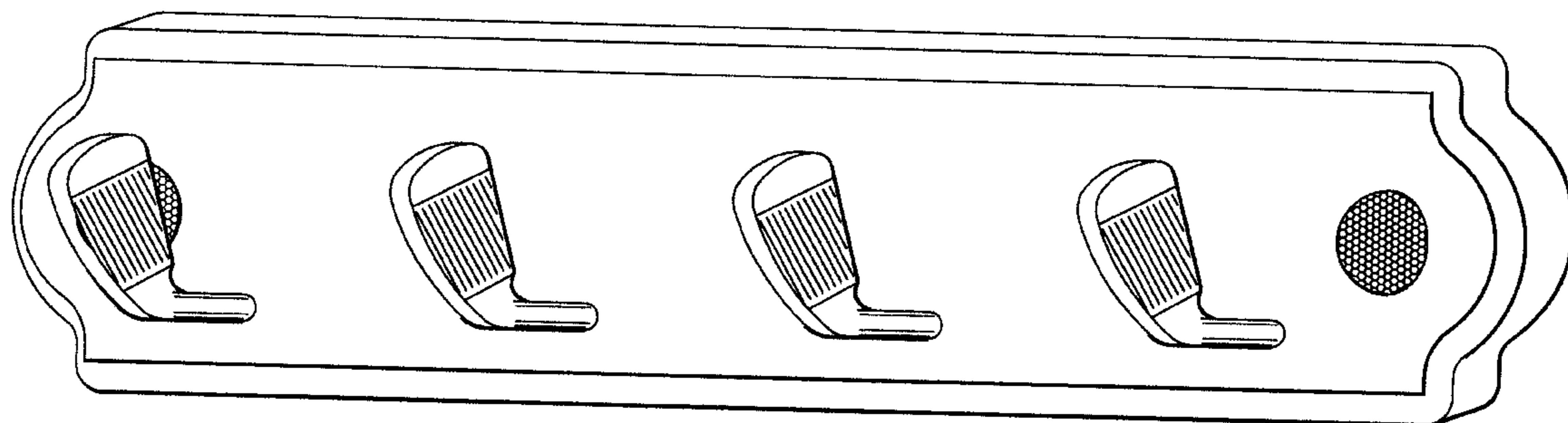
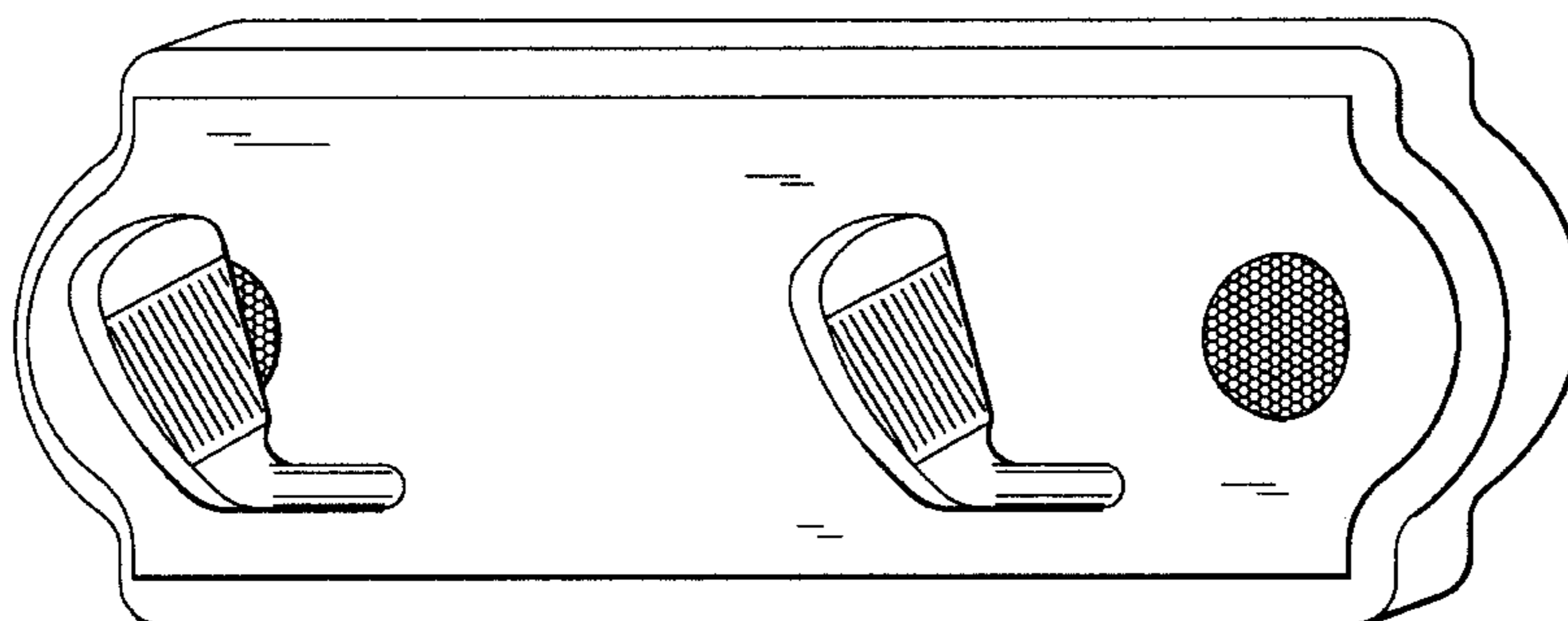

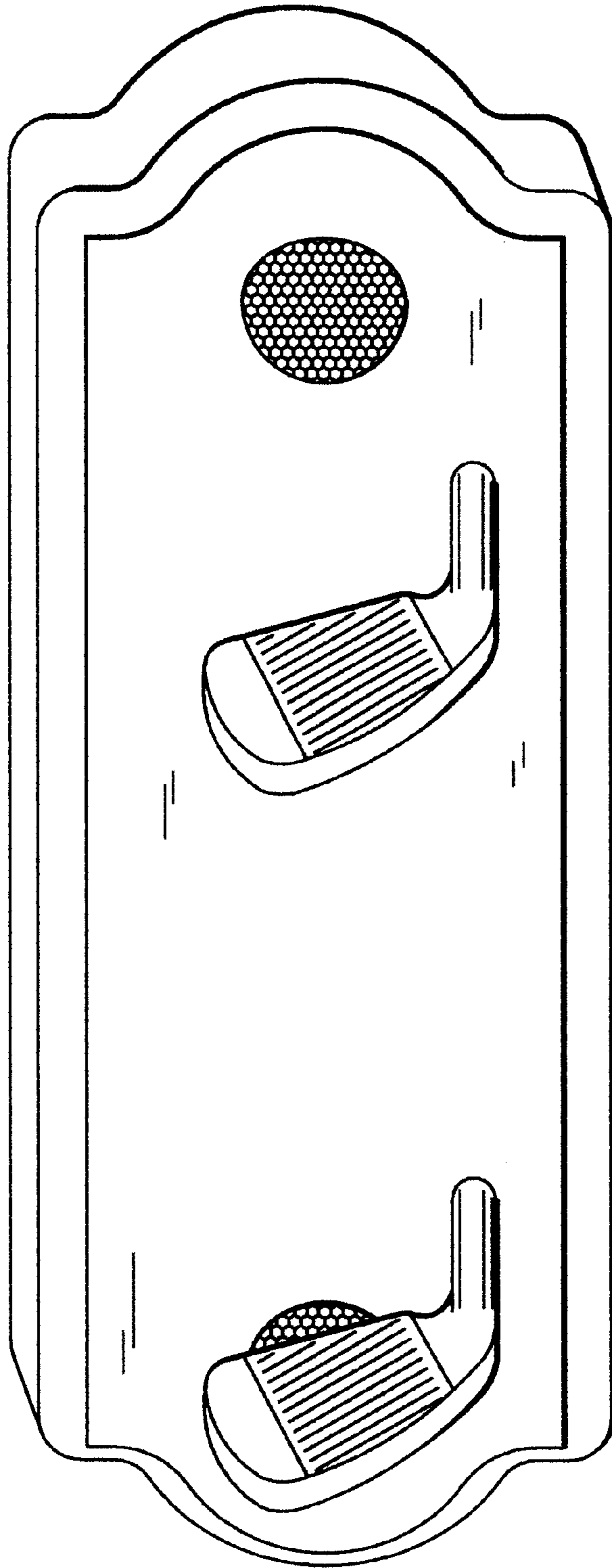

Fig. 1

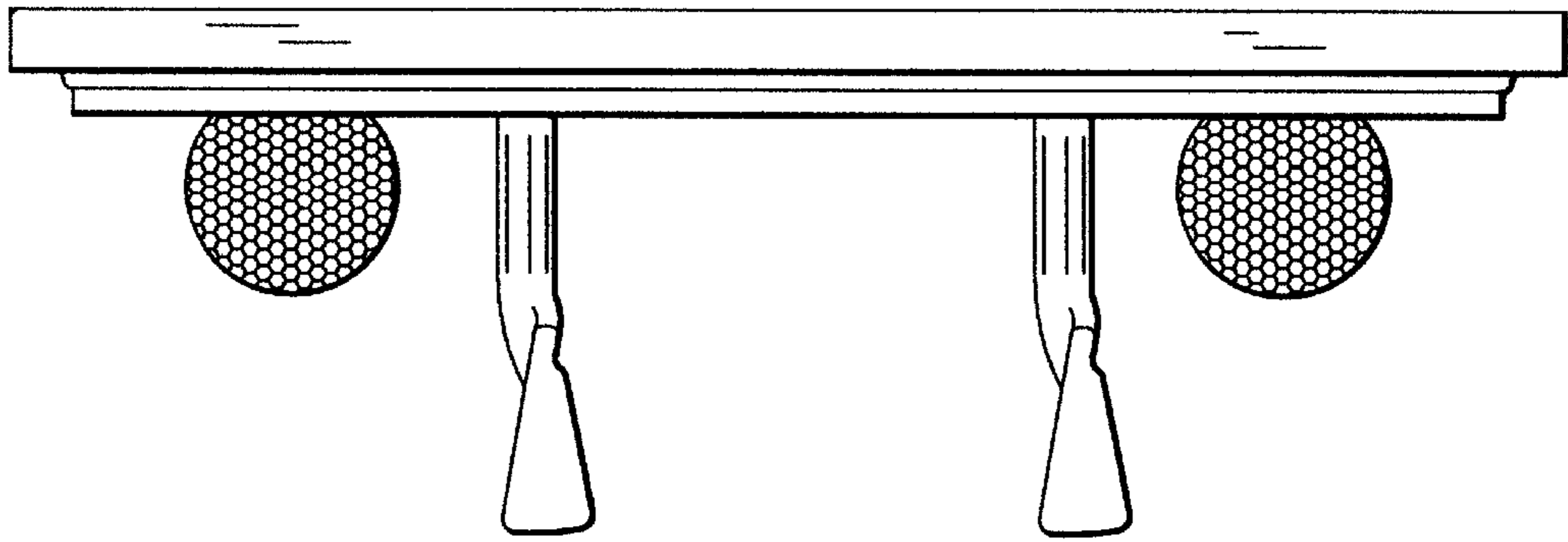

Fig. 6

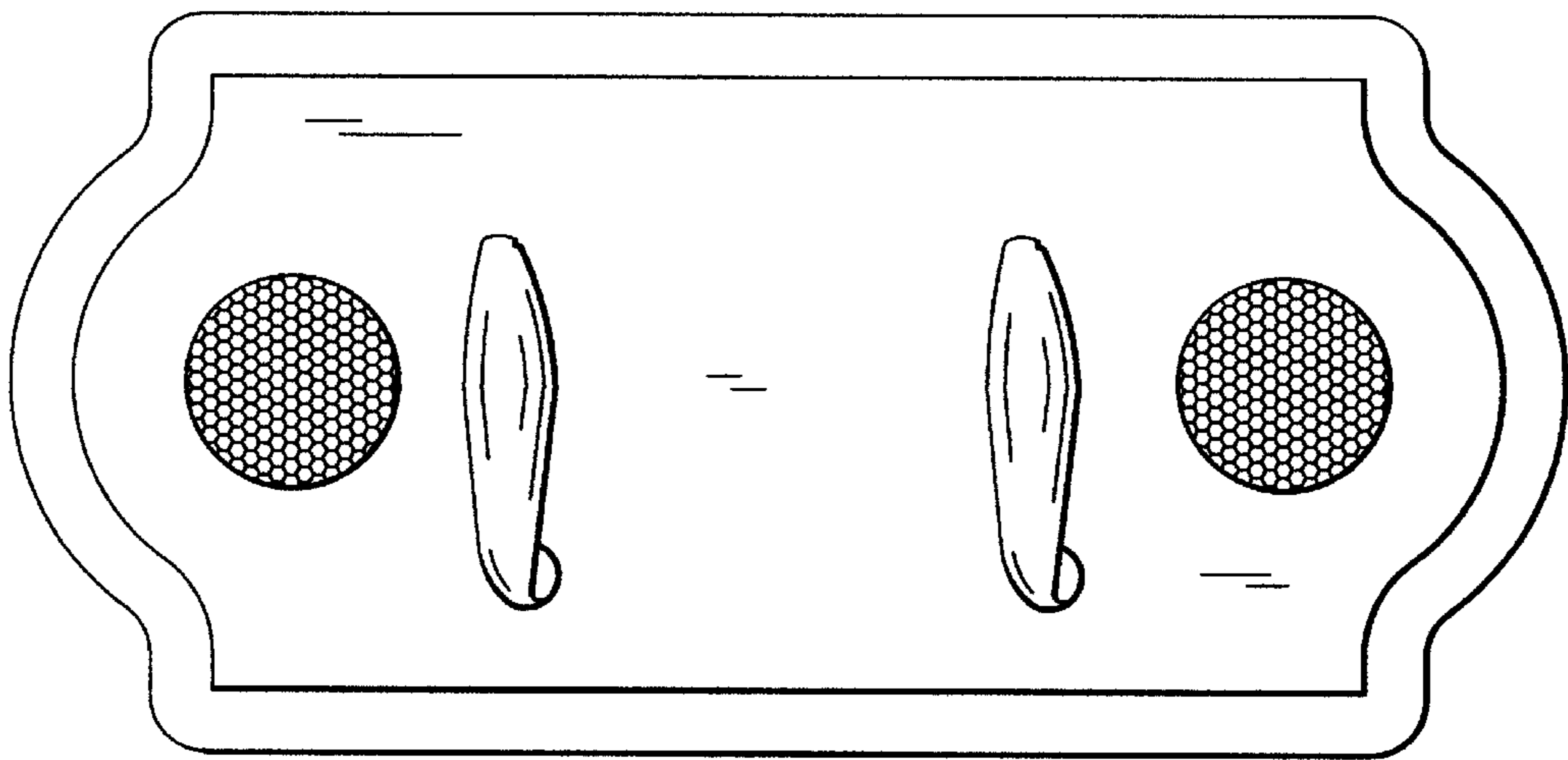

Fig. 2

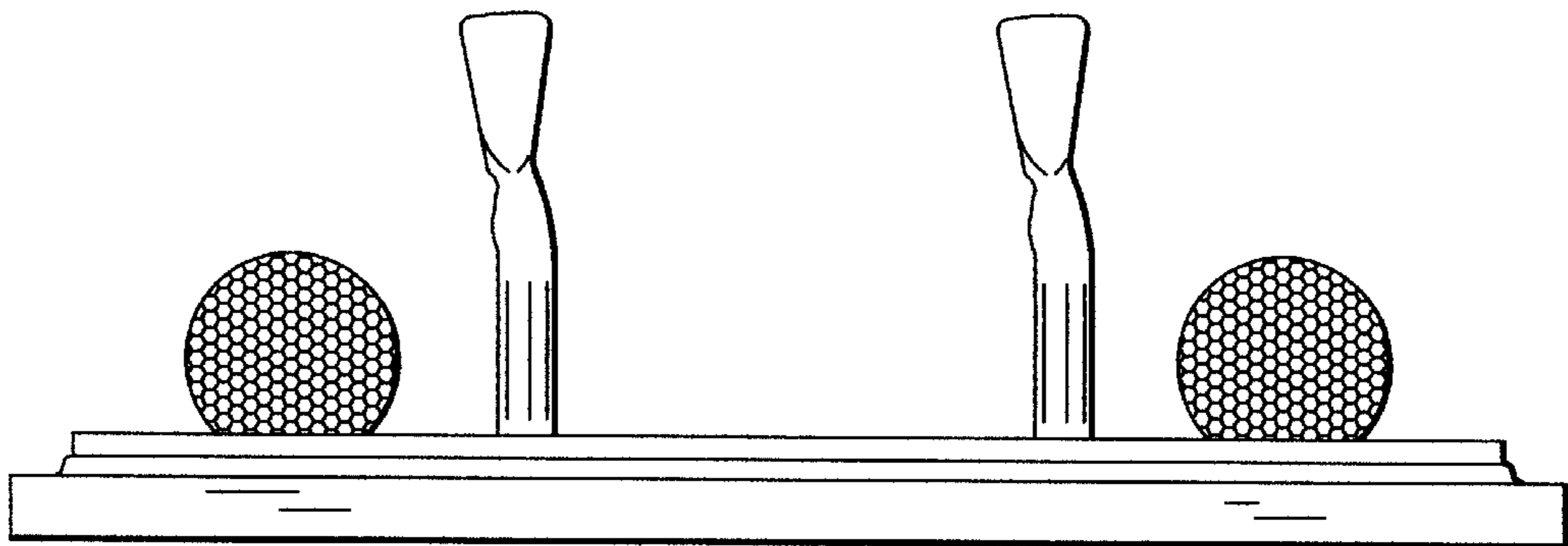

Fig. 7

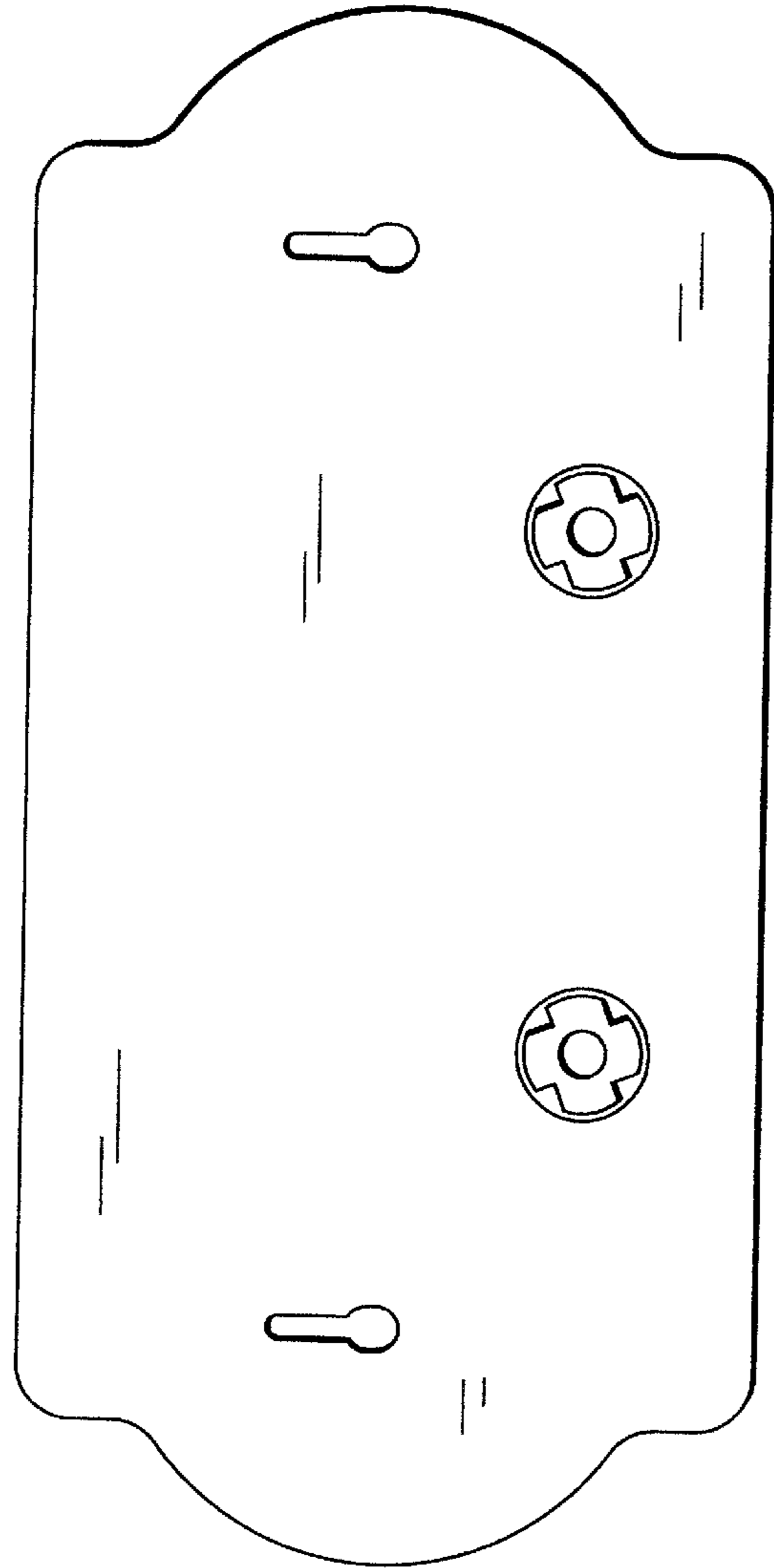

Fig. 5

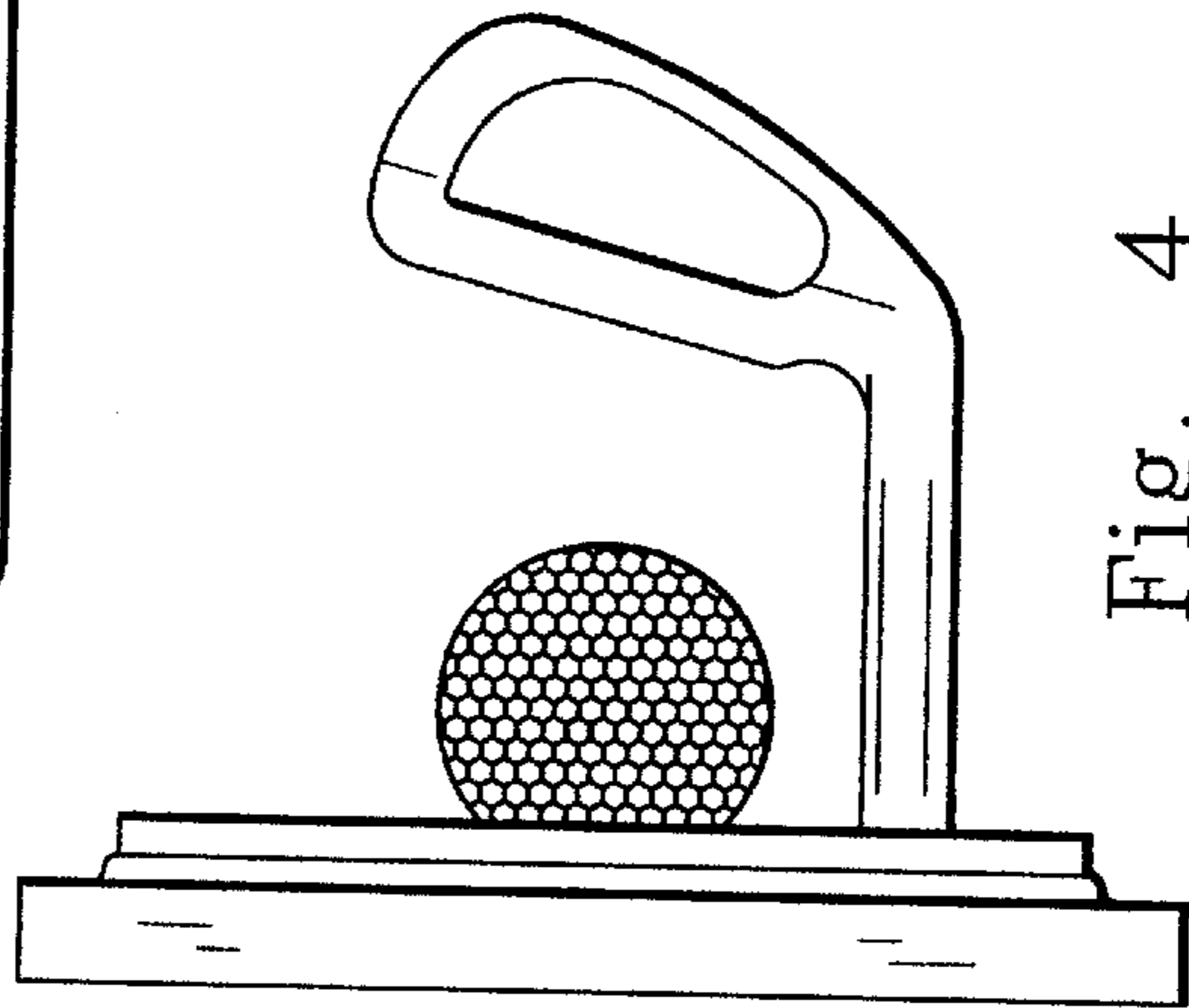

Fig. 4

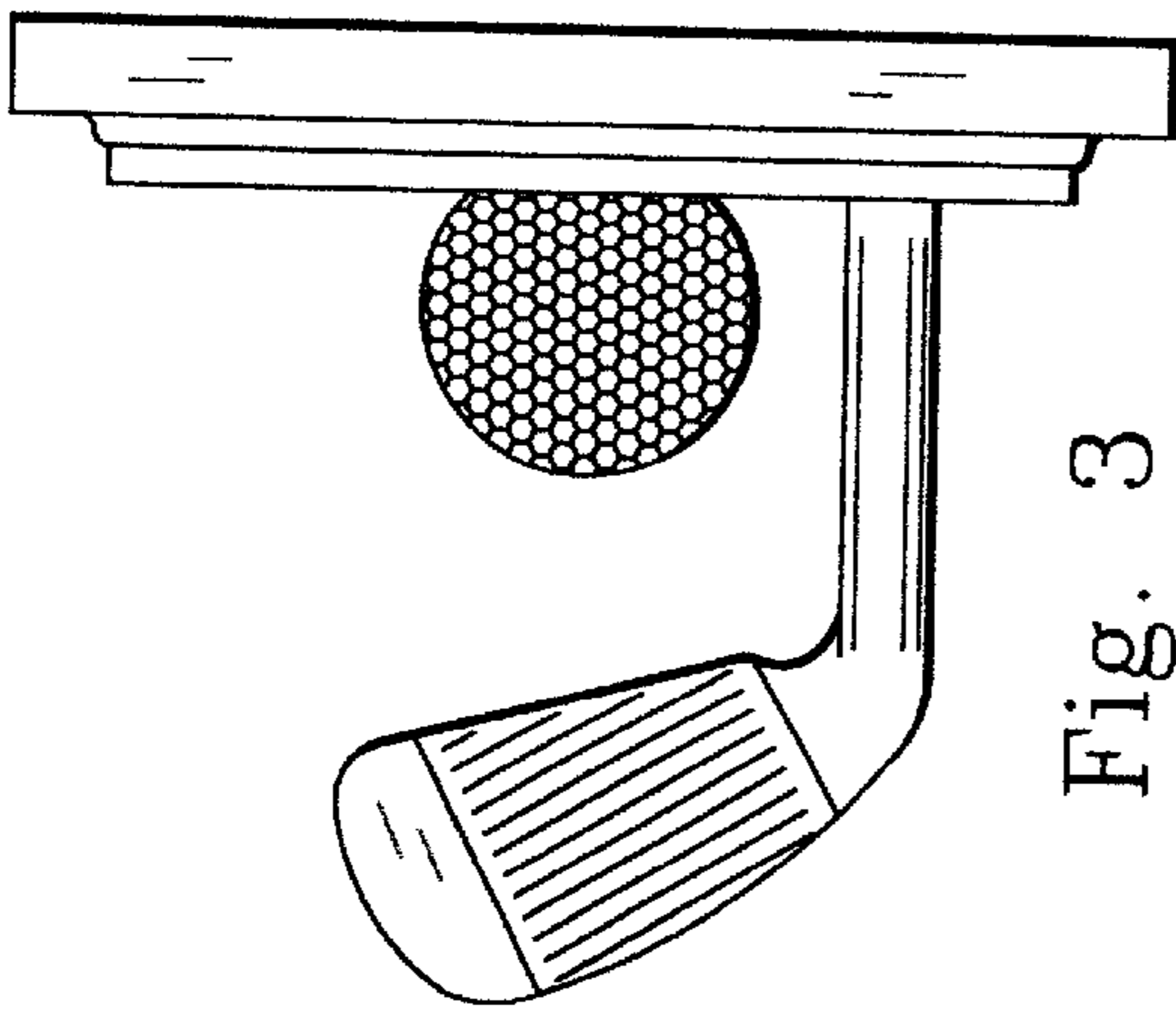

Fig. 3

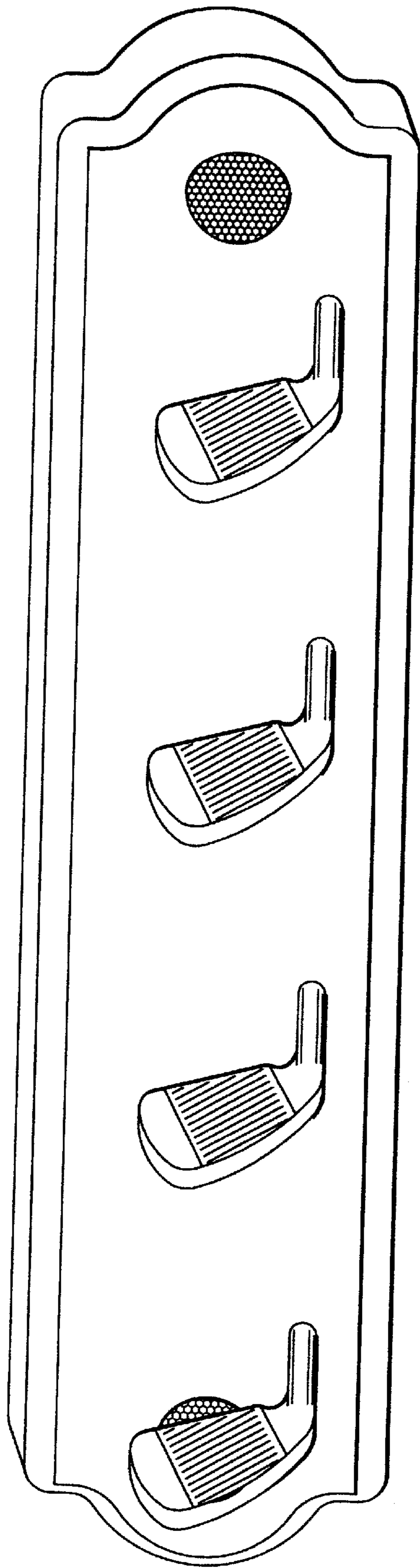

Fig. 8

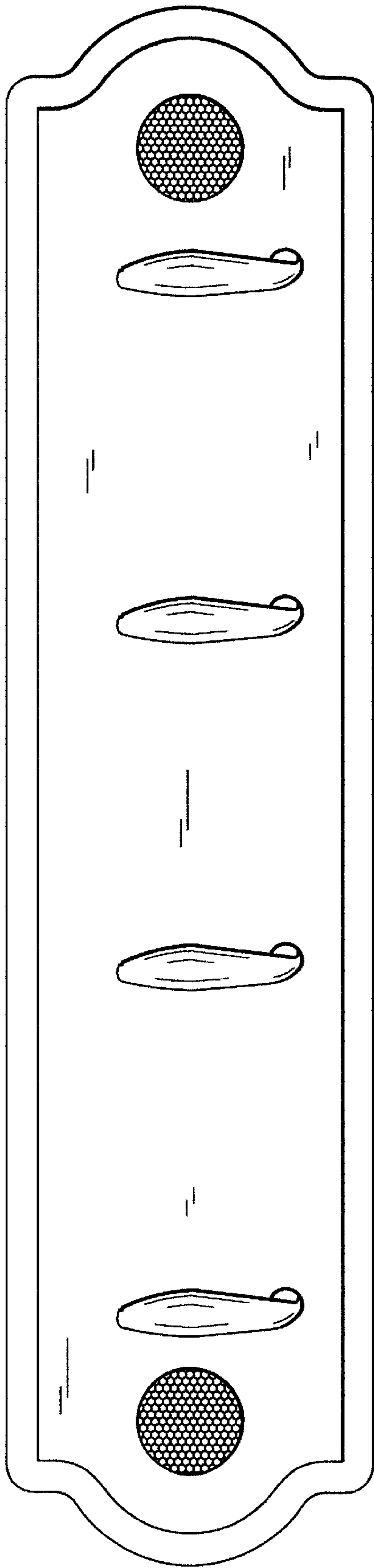

Fig. 9

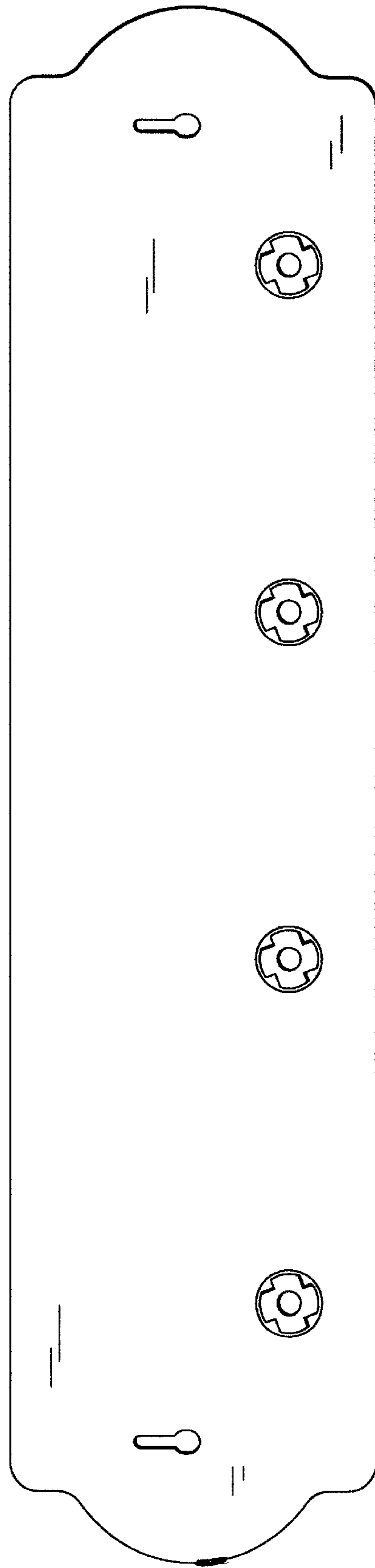

Fig. 12

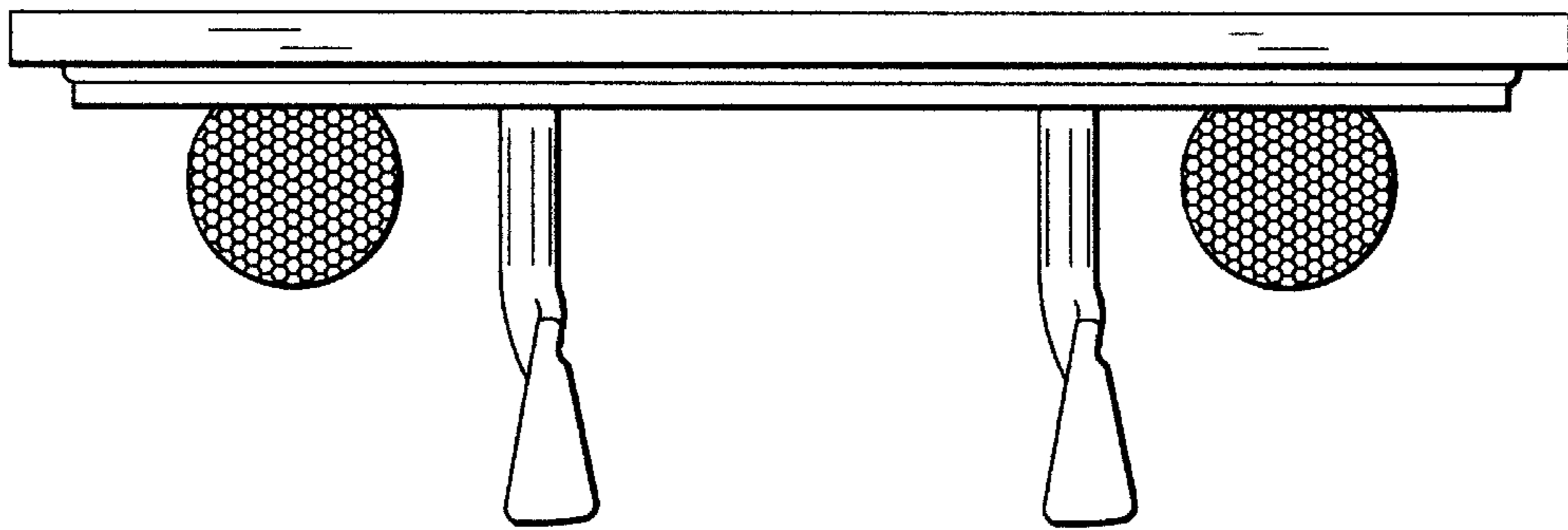

Fig. 13

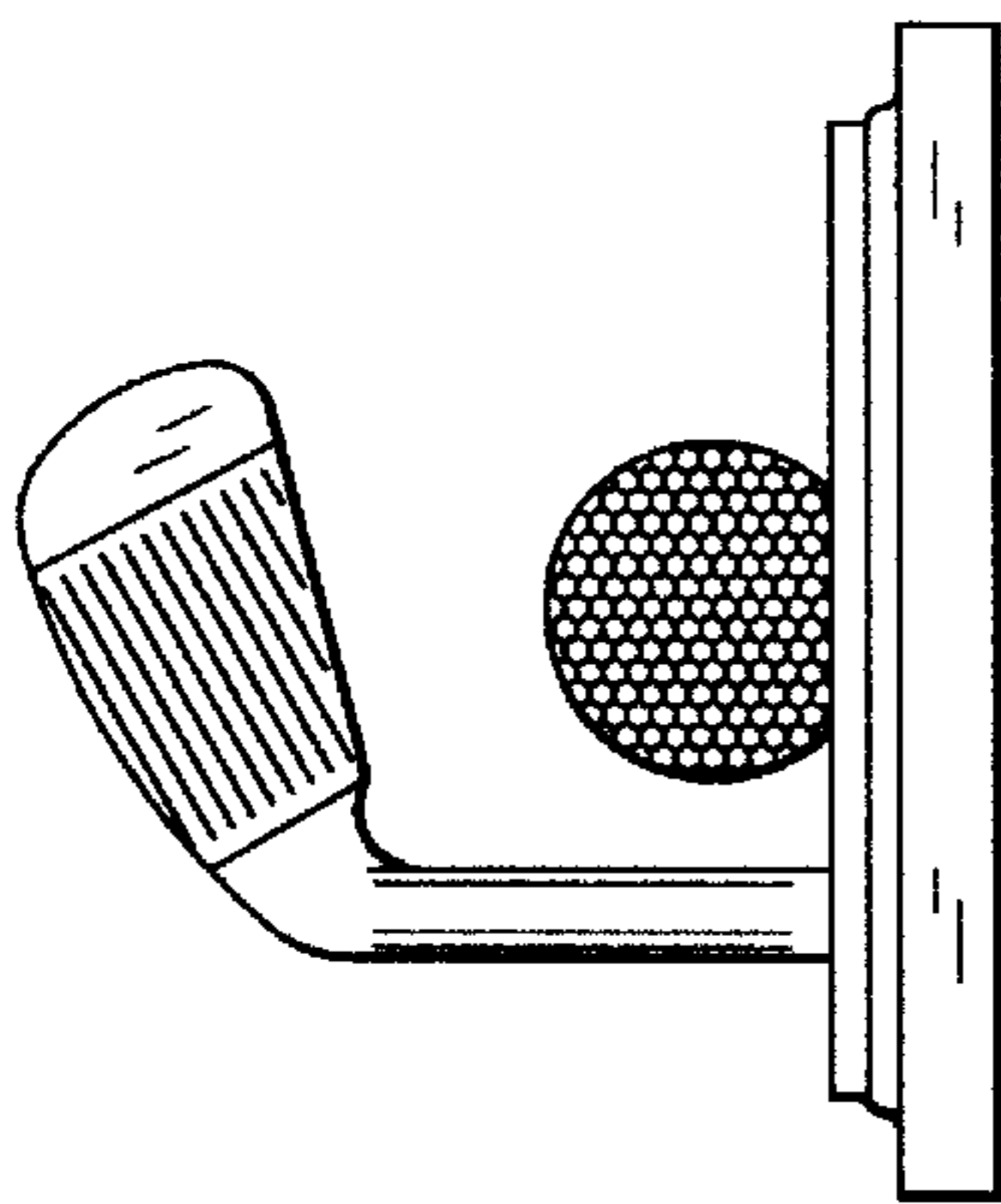

Fig. 10

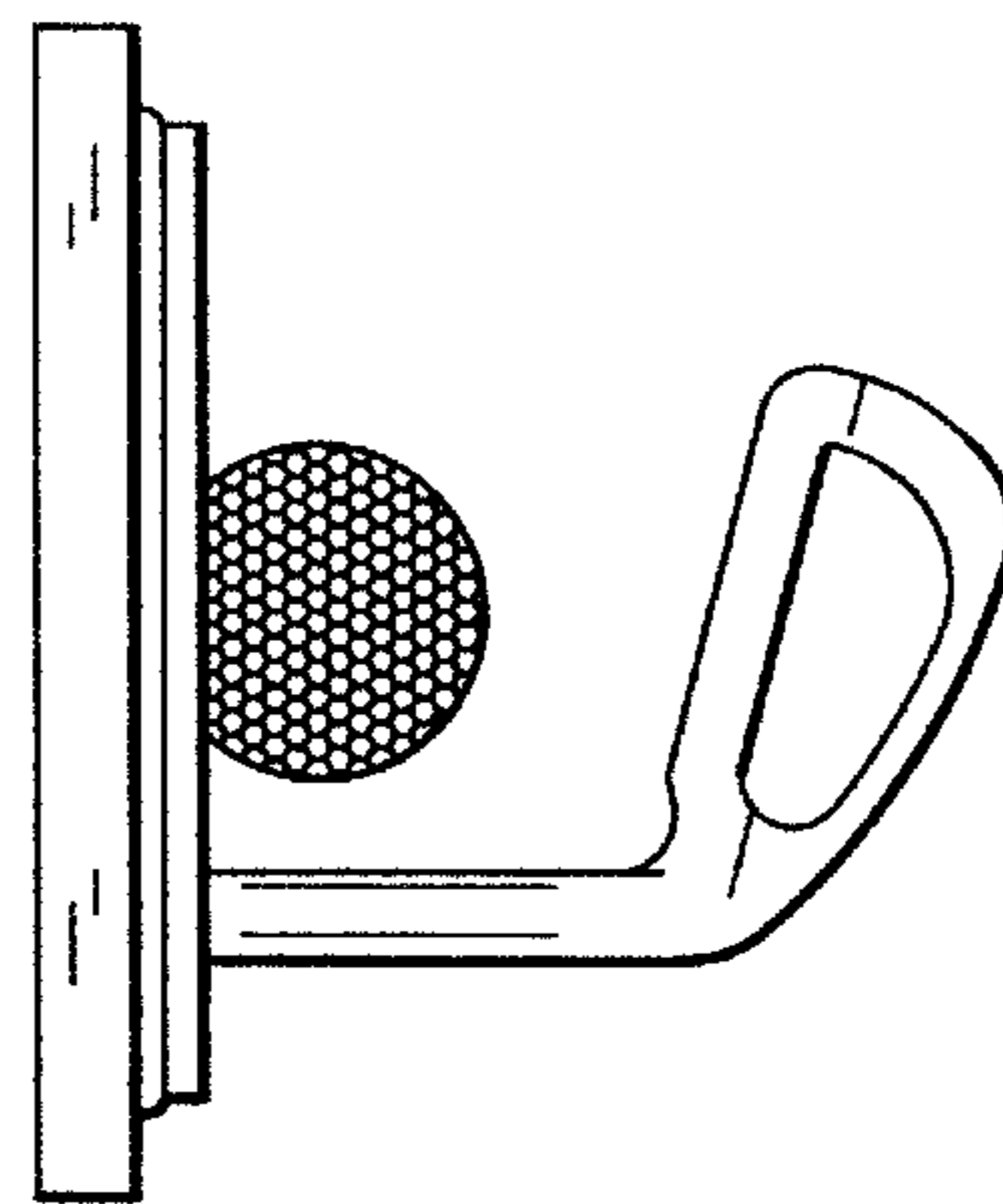

Fig. 11

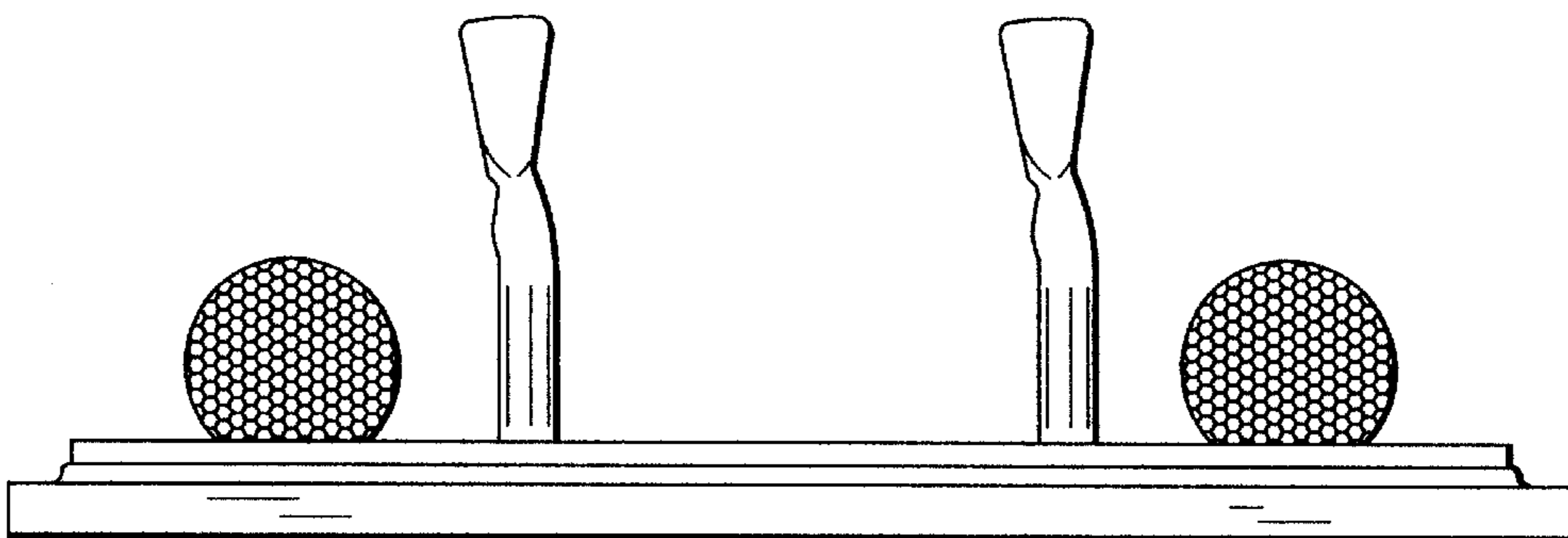

Fig. 14