



US00D486361S

(12) **United States Design Patent**
Wu

(10) **Patent No.:** **US D486,361 S**

(45) **Date of Patent:** **** Feb. 10, 2004**

(54) **SHEAR**

(76) **Inventor:** **Shih-Piao Wu**, 220-1 Lu Ho Road, Sec. 1, Lu Kang Town, Changhua (TW)

(**) **Term:** **14 Years**

(21) **Appl. No.:** **29/183,619**

(22) **Filed:** **Jun. 16, 2003**

(51) **LOC (7) Cl.** **08-01**

(52) **U.S. Cl.** **D8/5**

(58) **Field of Search** **D8/4, 5; 30/252-254**

(56) **References Cited**

U.S. PATENT DOCUMENTS

- D426,755 S * 6/2000 Wu D8/5
- D459,168 S * 6/2002 Meyerratken D8/5
- D462,586 S * 10/2002 Halpern et al. D8/5

* cited by examiner

Primary Examiner—Holly Baynham

(74) *Attorney, Agent, or Firm*—Rabin & Berdo, P.C.

(57) **CLAIM**

The ornamental design for a shear, as shown and described.

DESCRIPTION

FIG. 1. is a front elevational view of a shear showing my new design;

FIG. 2. is a rear elevational view thereof;

FIG. 3. is a left side elevational view thereof;

FIG. 4. is a right side elevational view thereof;

FIG. 5. is a top plan view thereof;

FIG. 6. is a bottom plan view thereof; and,

FIG. 7. is a perspective view thereof.

1 Claim, 4 Drawing Sheets

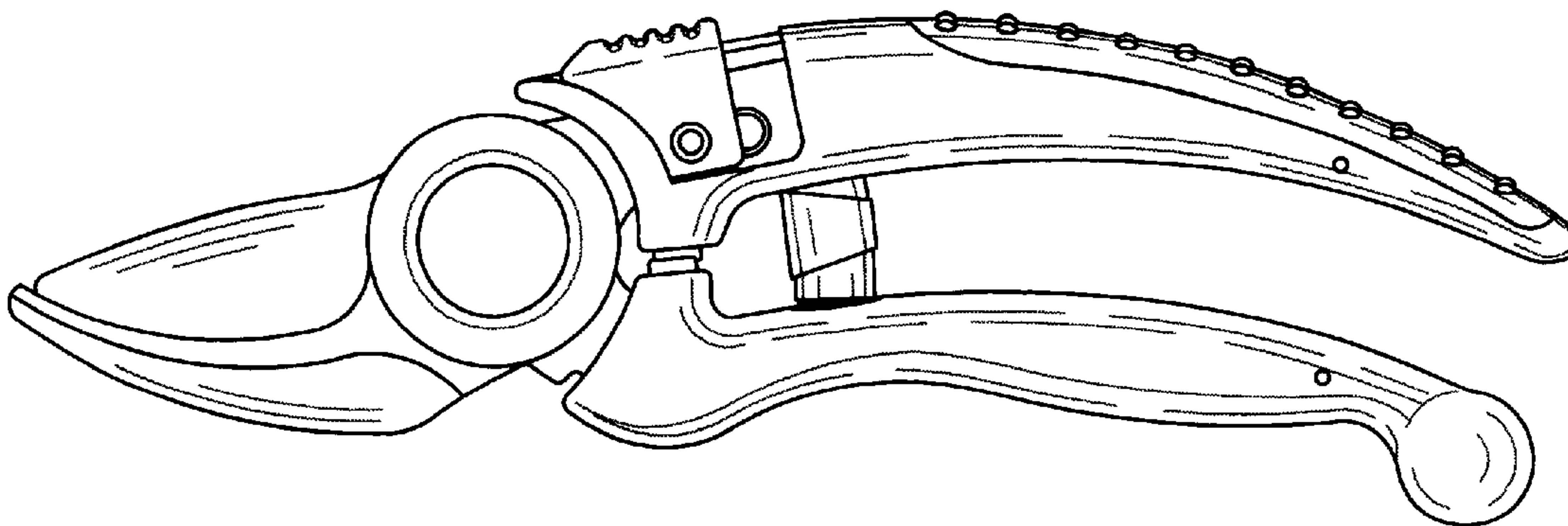

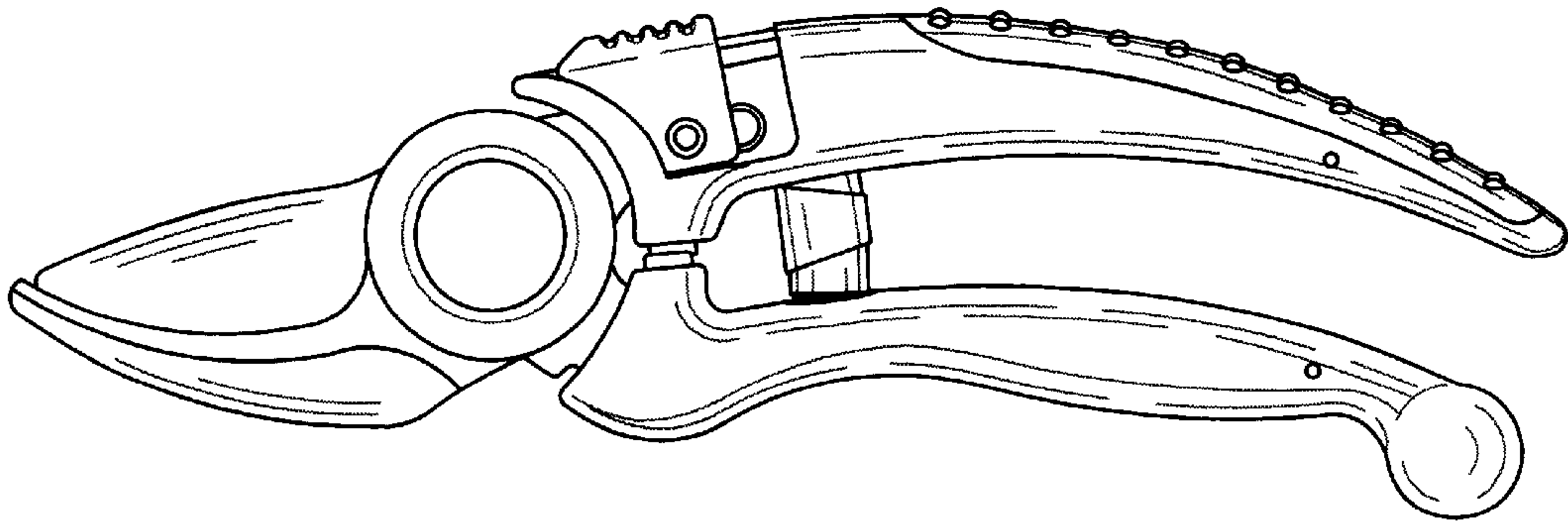

FIG.1

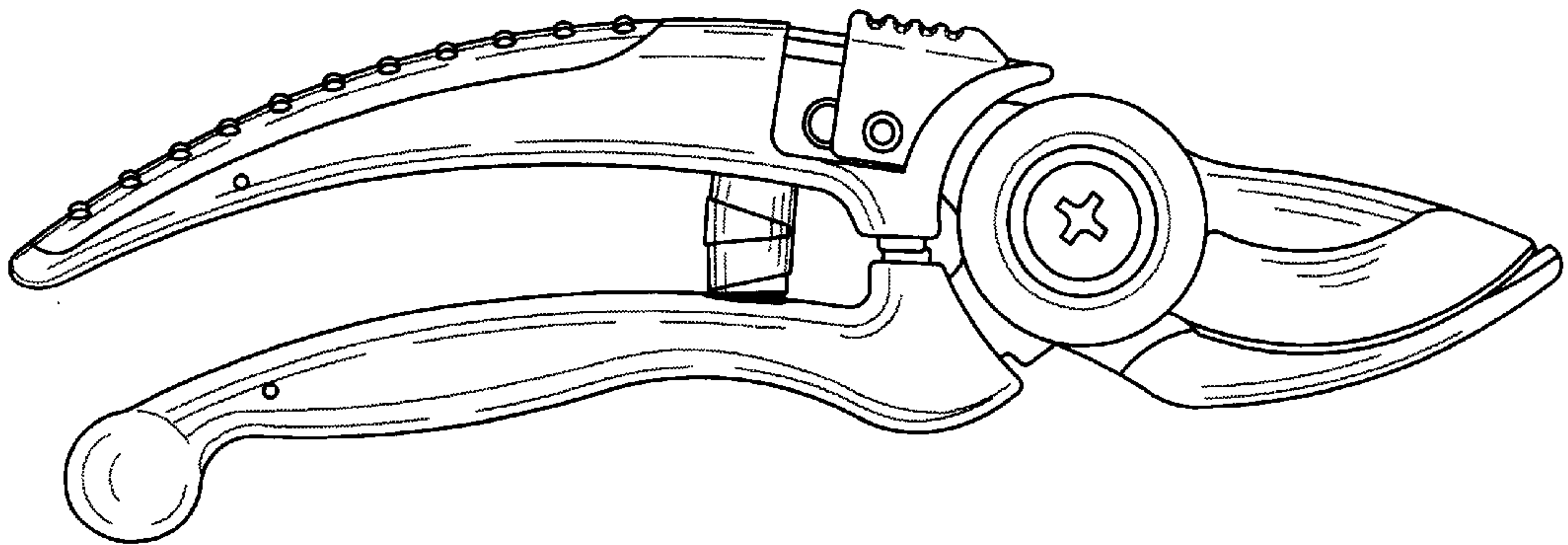

FIG.2

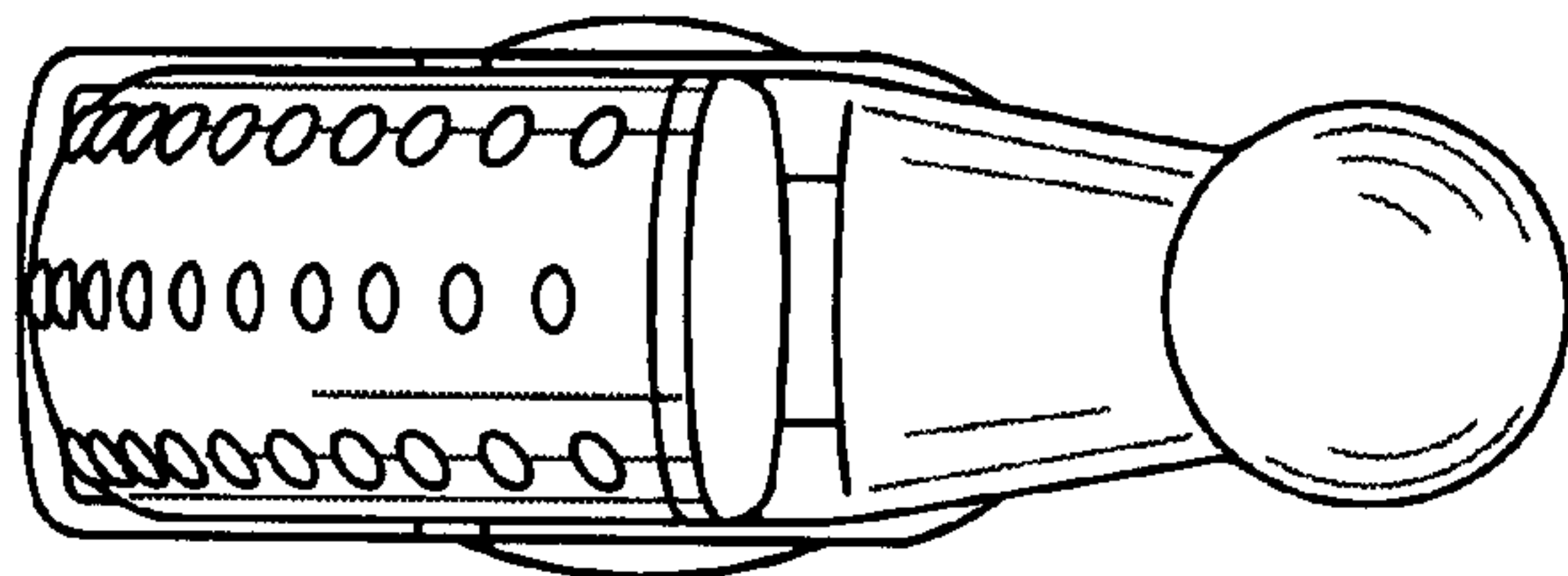

FIG. 4

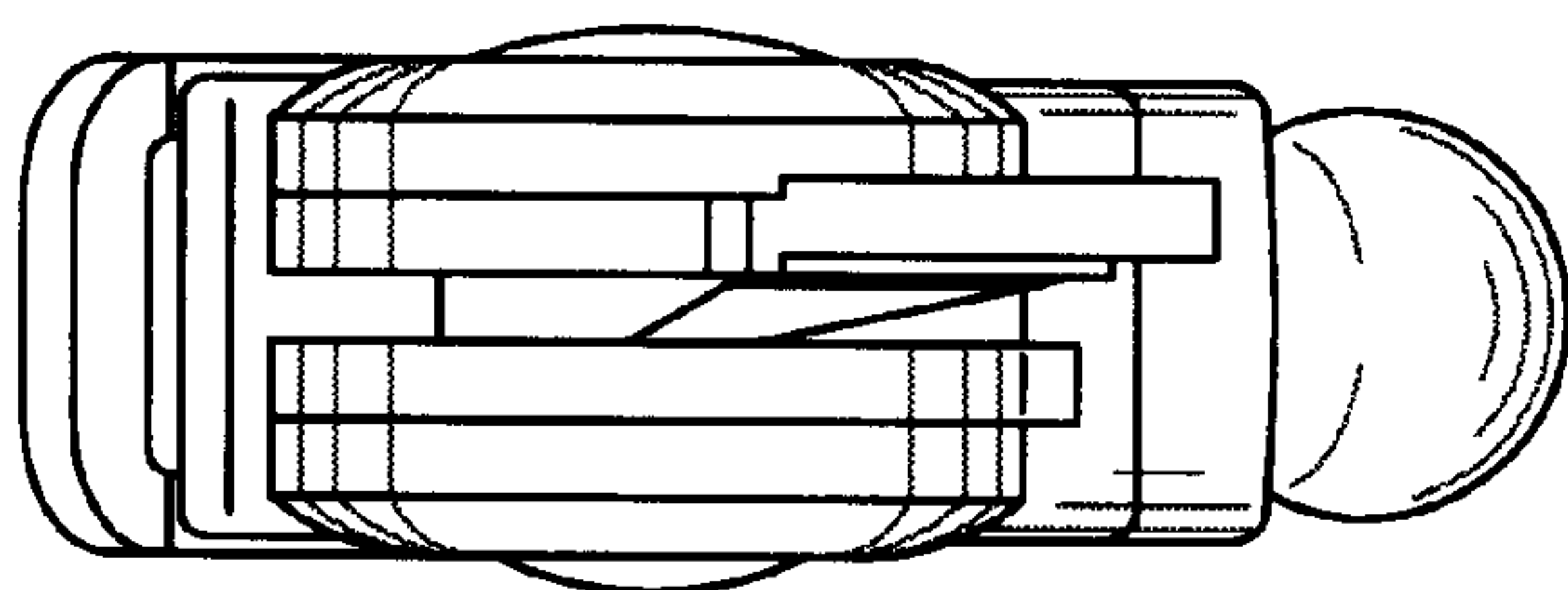

FIG. 3

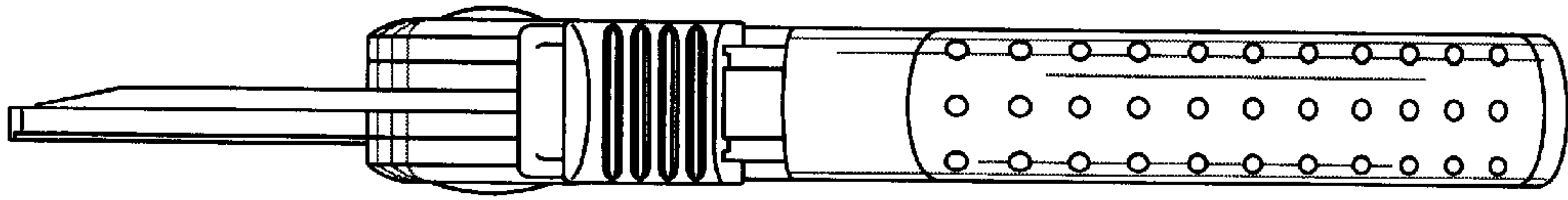

FIG. 5

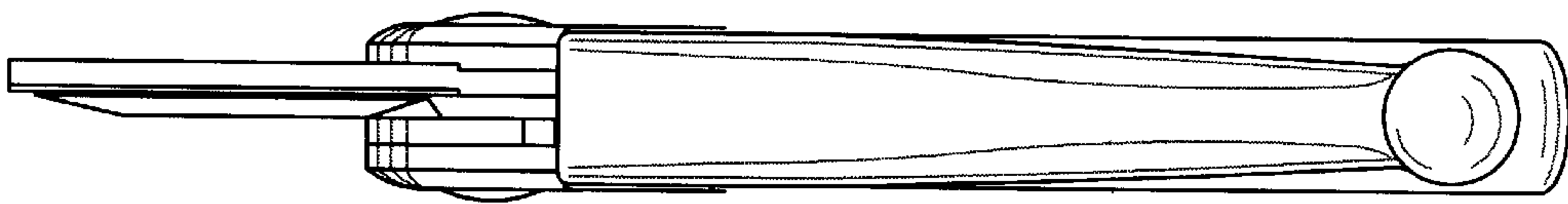

FIG. 6

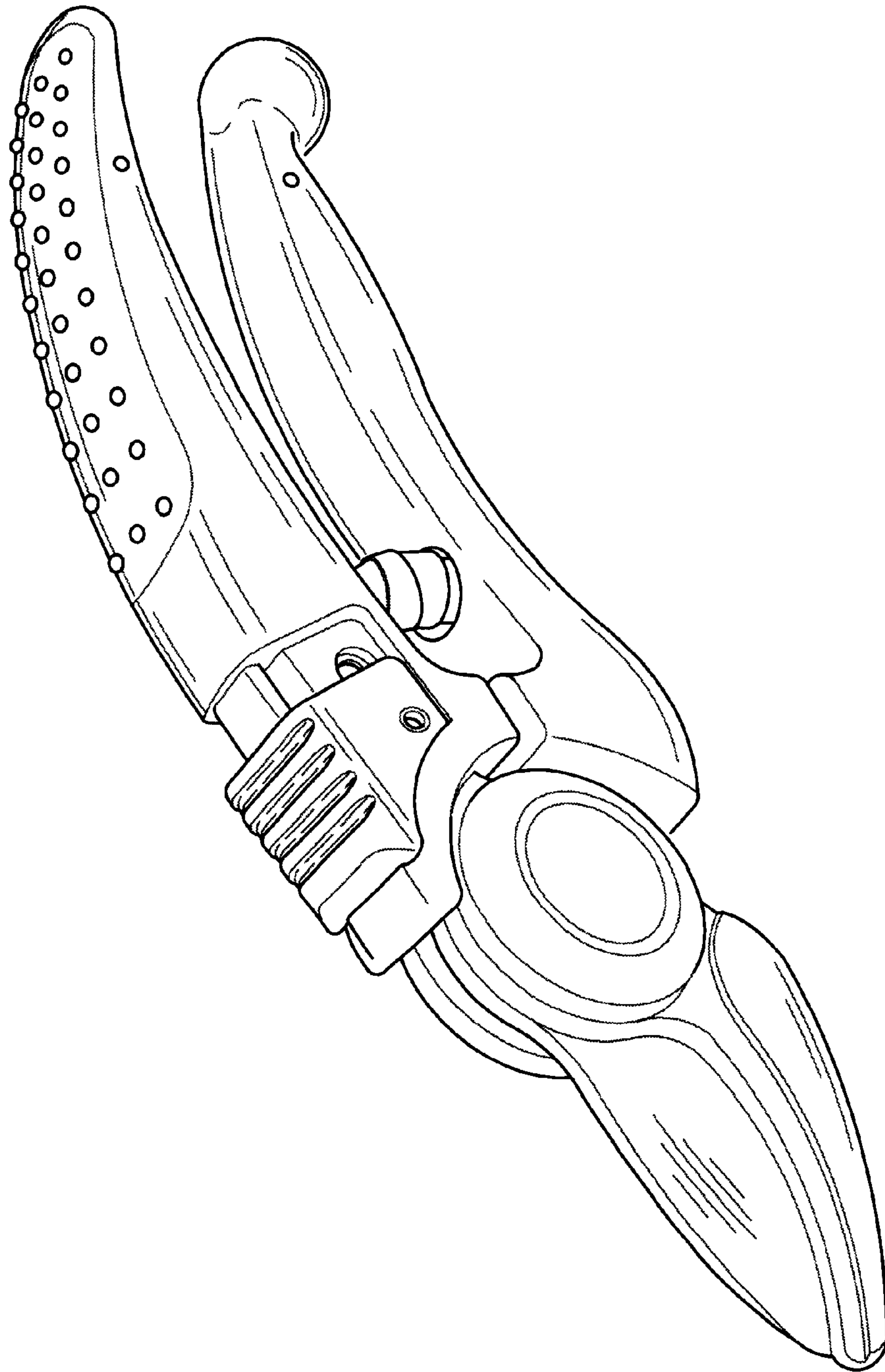

FIG. 7