



US00D486277S

(12) **United States Design Patent**  
Stern et al.

(10) **Patent No.:** **US D486,277 S**

(45) **Date of Patent:** **\*\* Feb. 3, 2004**

(54) **DOG HOUSE DRYER**

D377,406 S \* 1/1997 McKinstry ..... D30/108  
D443,732 S \* 6/2001 Gelhar ..... D30/108

(75) Inventors: **Jules Stern**, Spring Valley, NY (US);  
**David Stern**, Montebello, NY (US);  
**Kenneth Stern**, Montebello, NY (US);  
**Peter Stankus**, Pearl River, NY (US)

\* cited by examiner

*Primary Examiner*—Pamela Burgess  
(74) *Attorney, Agent, or Firm*—Michael E. Zall

(73) Assignee: **Metropolitan Vacuum Cleaner Co., Inc.**, Suffern, NY (US)

(57) **CLAIM**

I claim the ornamental design for the dog house dryer, as shown and described.

(\*\*) Term: **14 Years**

**DESCRIPTION**

(21) Appl. No.: **29/179,665**

FIG. 1 is a perspective view of the dog house dryer from the right front side showing our new design;  
FIG. 2 is a front view thereof;  
FIG. 3 is a rear view thereof;  
FIG. 4 is a left view thereof;  
FIG. 5 is a right view thereof;  
FIG. 6 is a top view thereof;  
FIG. 7 is a bottom view thereof; and,  
FIG. 8 is a perspective view from the right front side thereof, the broken lines showing accessories are for illustrative purposes only and form no part of the claimed design.  
The broken lines in FIGS. 1-7 are for illustrative purposes only and form no part of the claimed design.

(22) Filed: **Apr. 14, 2003**

(51) **LOC (7) Cl.** ..... **30-99**

(52) **U.S. Cl.** ..... **D30/158**; D30/108

(58) **Field of Search** ..... D30/158, 108,  
D30/109, 126; 119/673, 676, 677, 678,  
606, 668, 753, 756; 34/523; D21/511

(56) **References Cited**

**U.S. PATENT DOCUMENTS**

3,596,636 A \* 8/1971 Stobaugh ..... 119/174  
D333,367 S \* 2/1993 Pirri ..... D30/110  
5,448,966 A \* 9/1995 McKinnon et al. .... 119/676

**1 Claim, 8 Drawing Sheets**

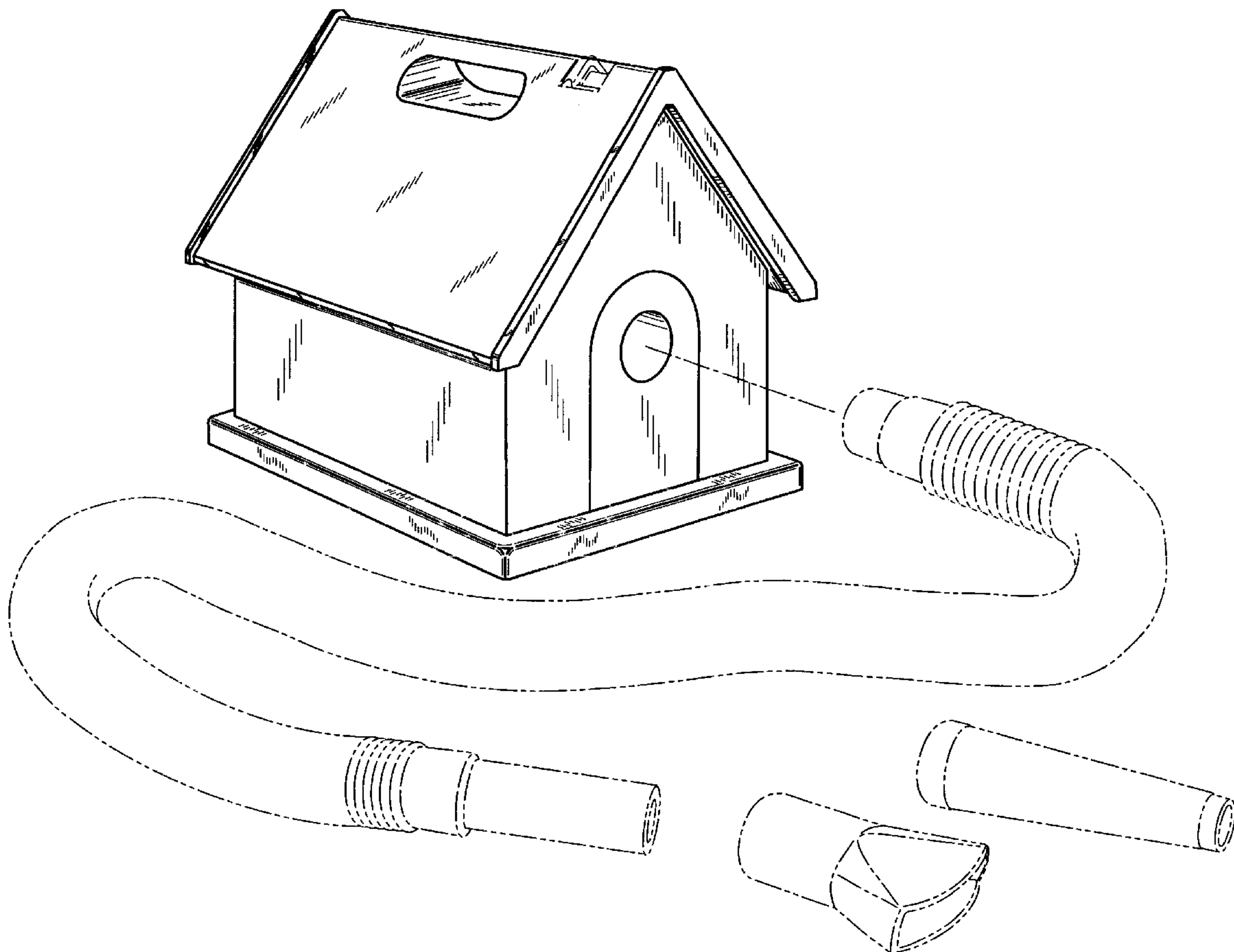

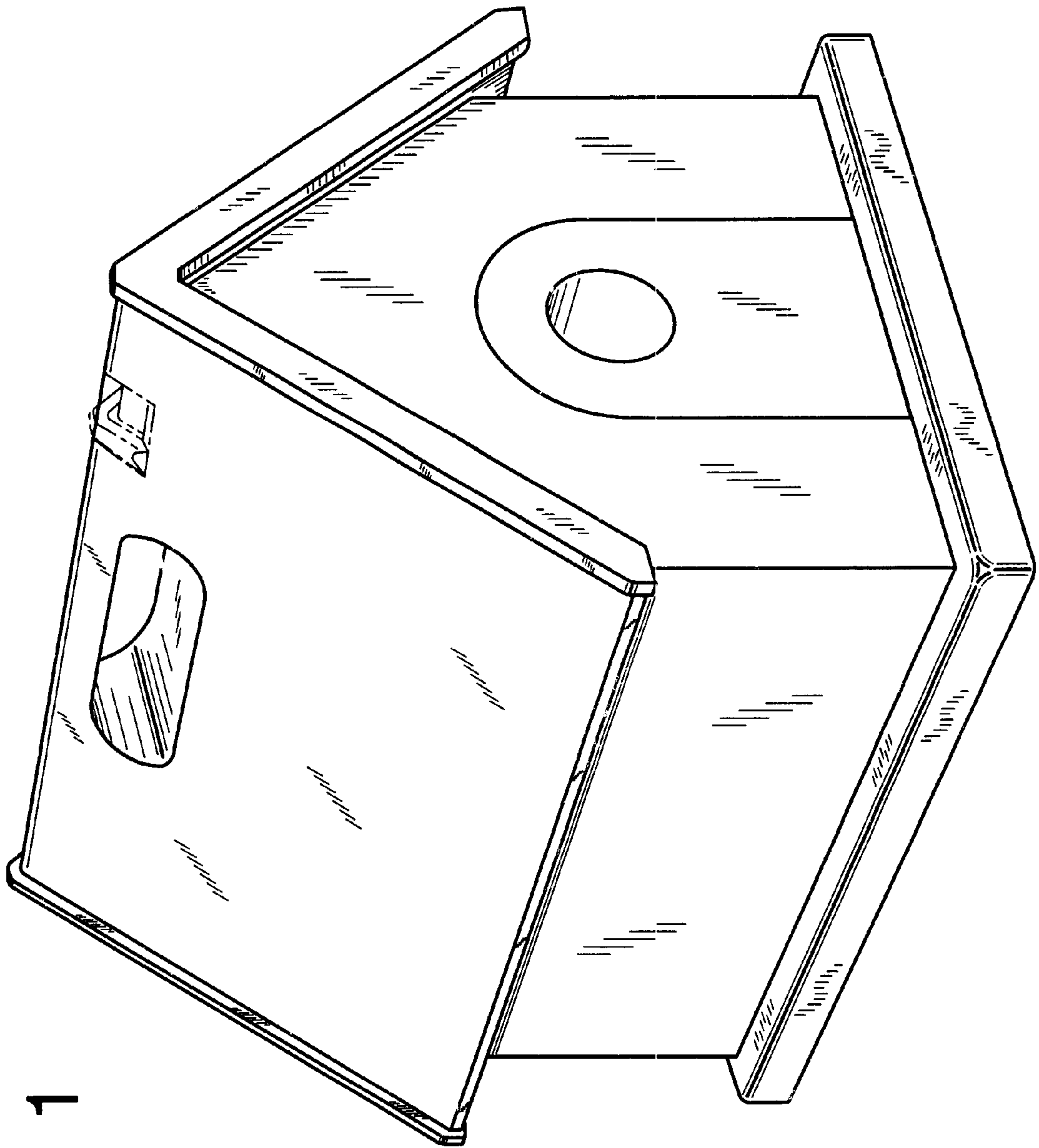

FIG. 1

FIG. 2

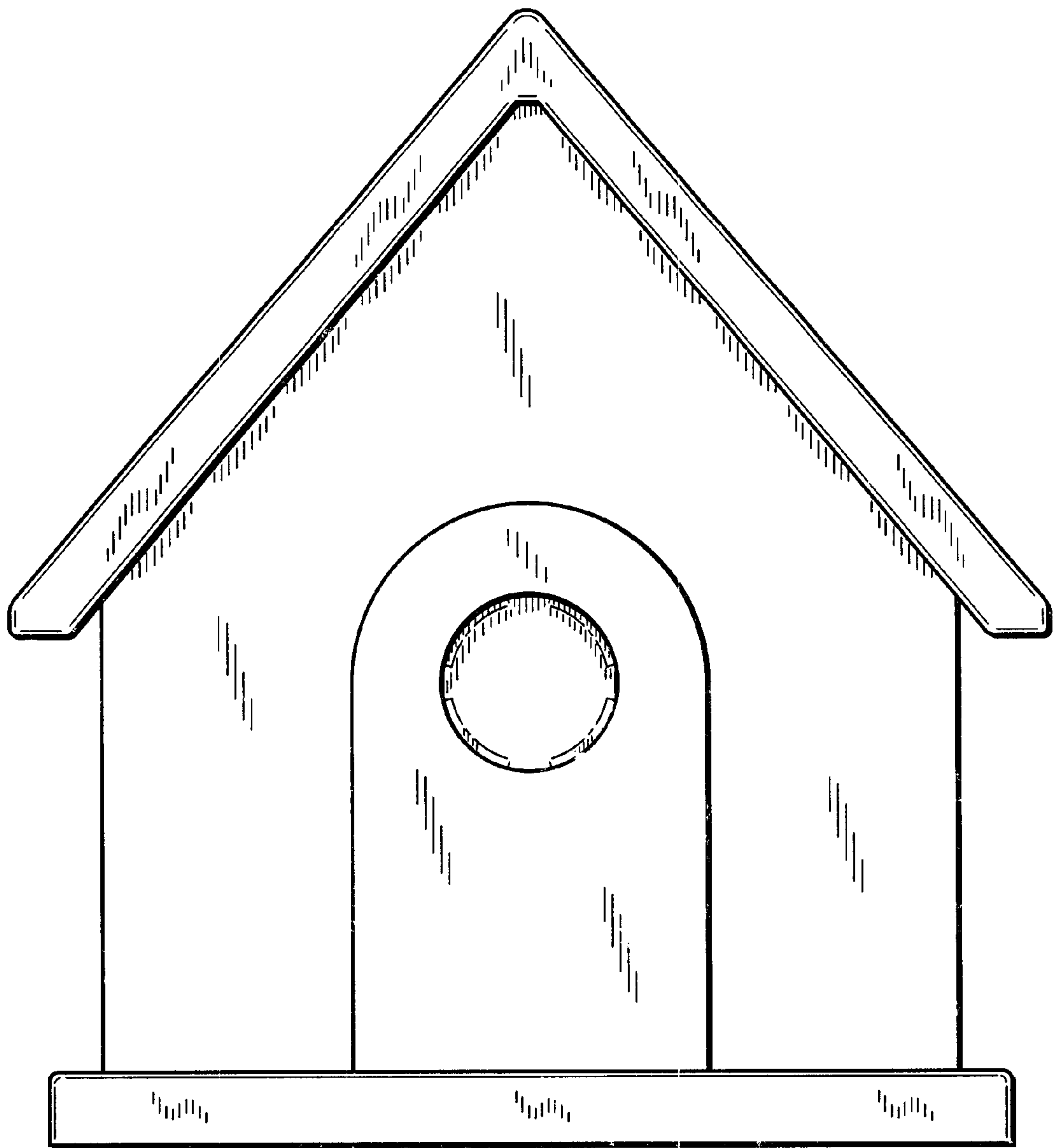

FIG. 3

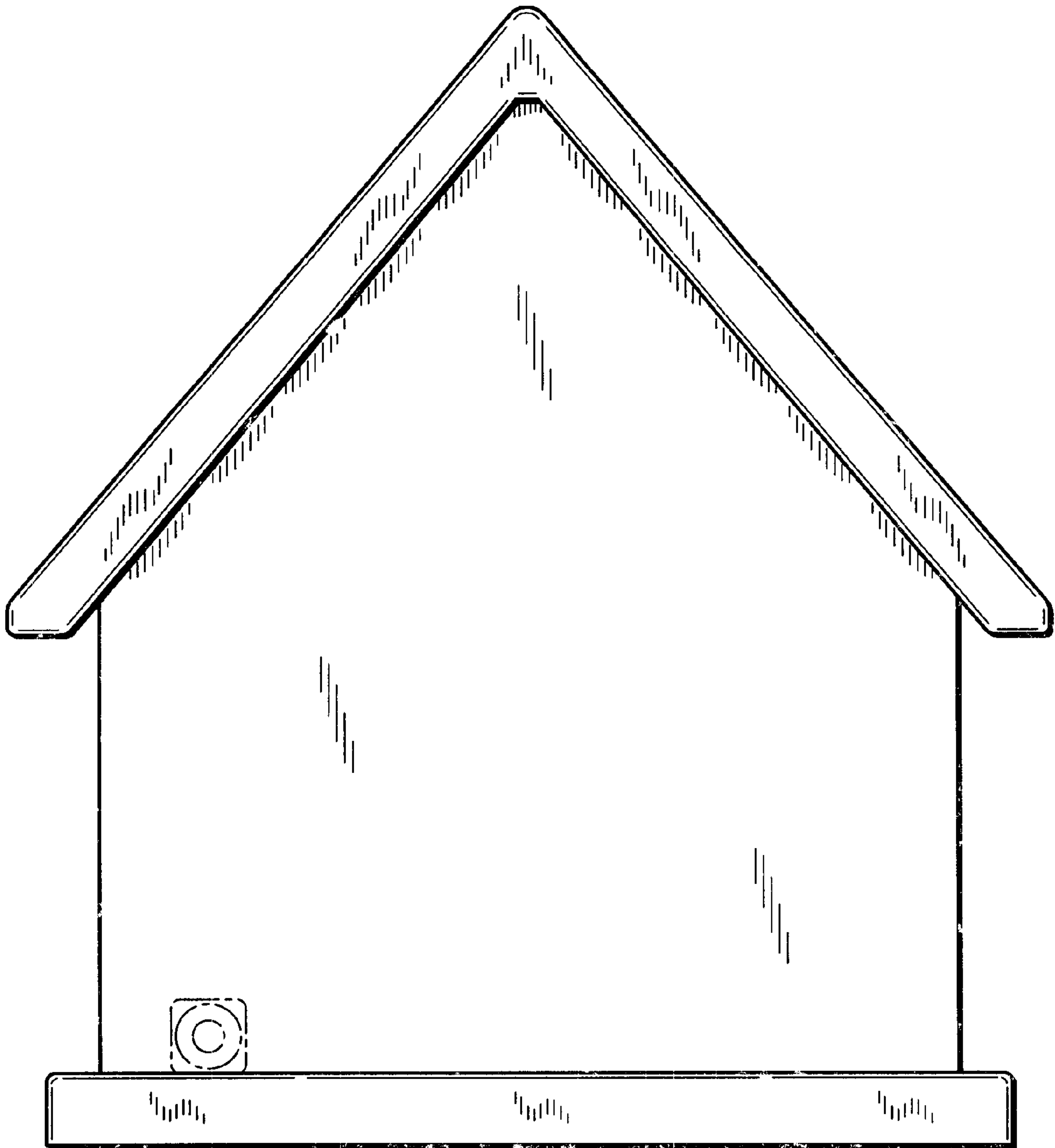

FIG. 4

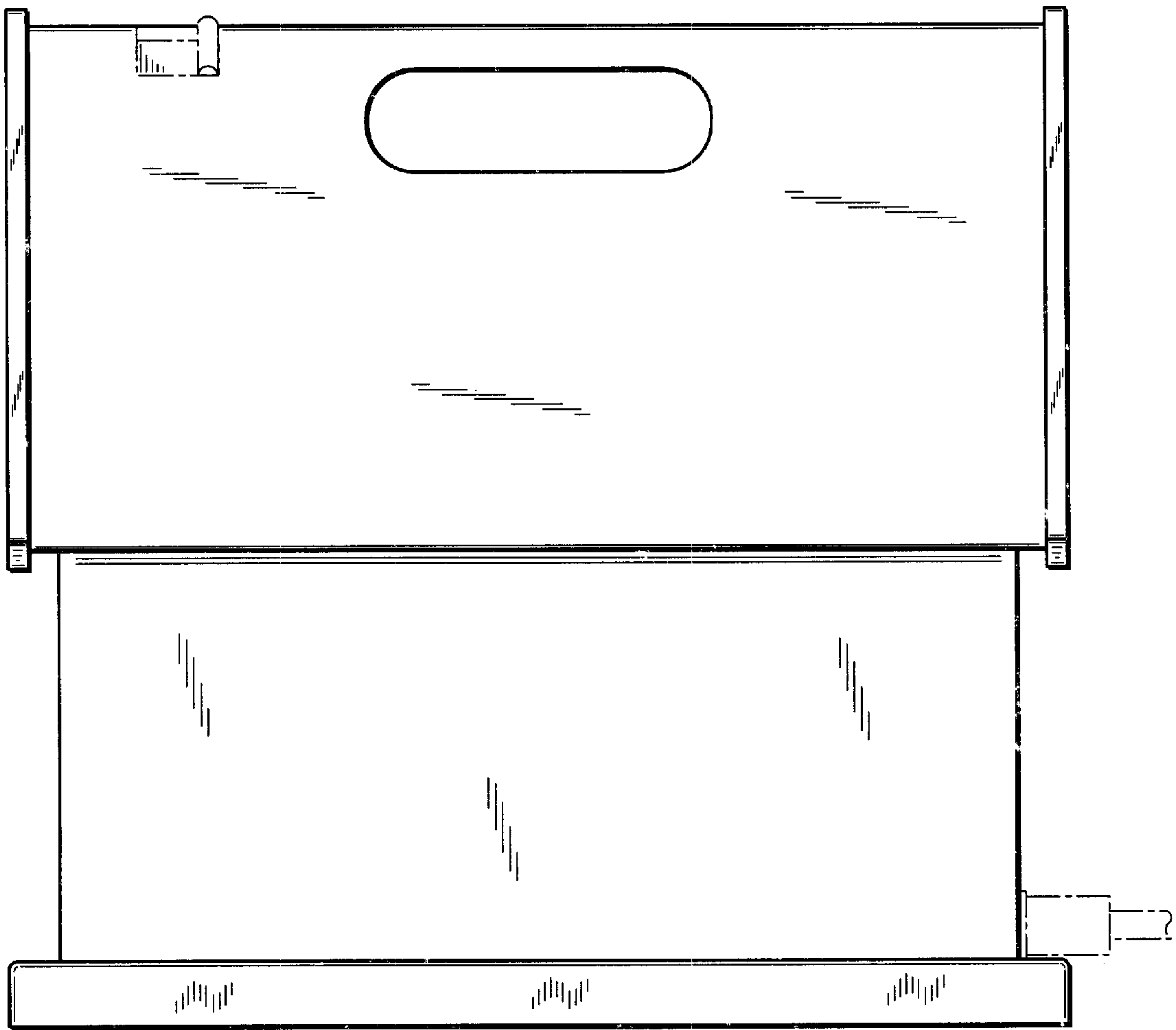

FIG. 5

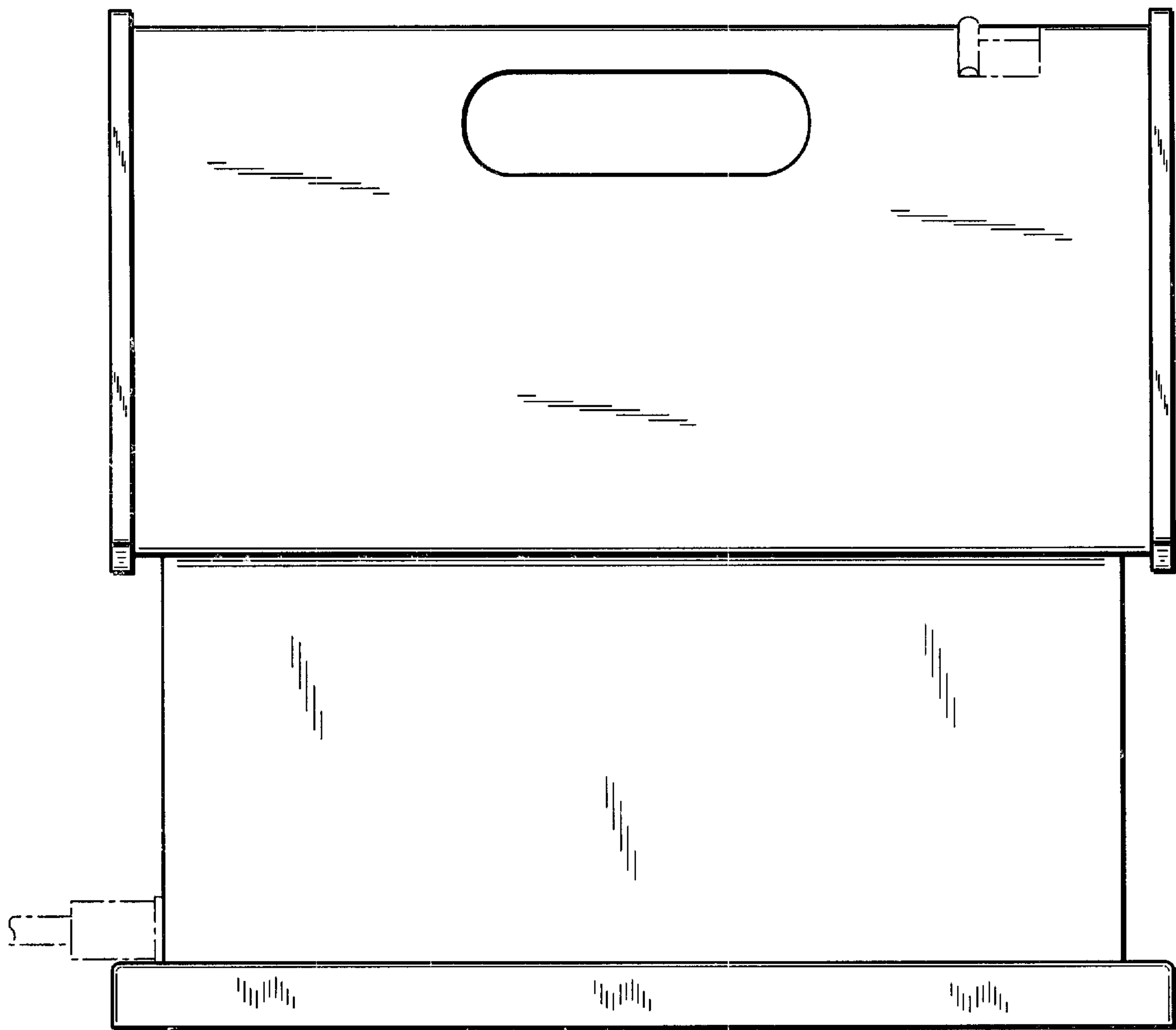

FIG. 6

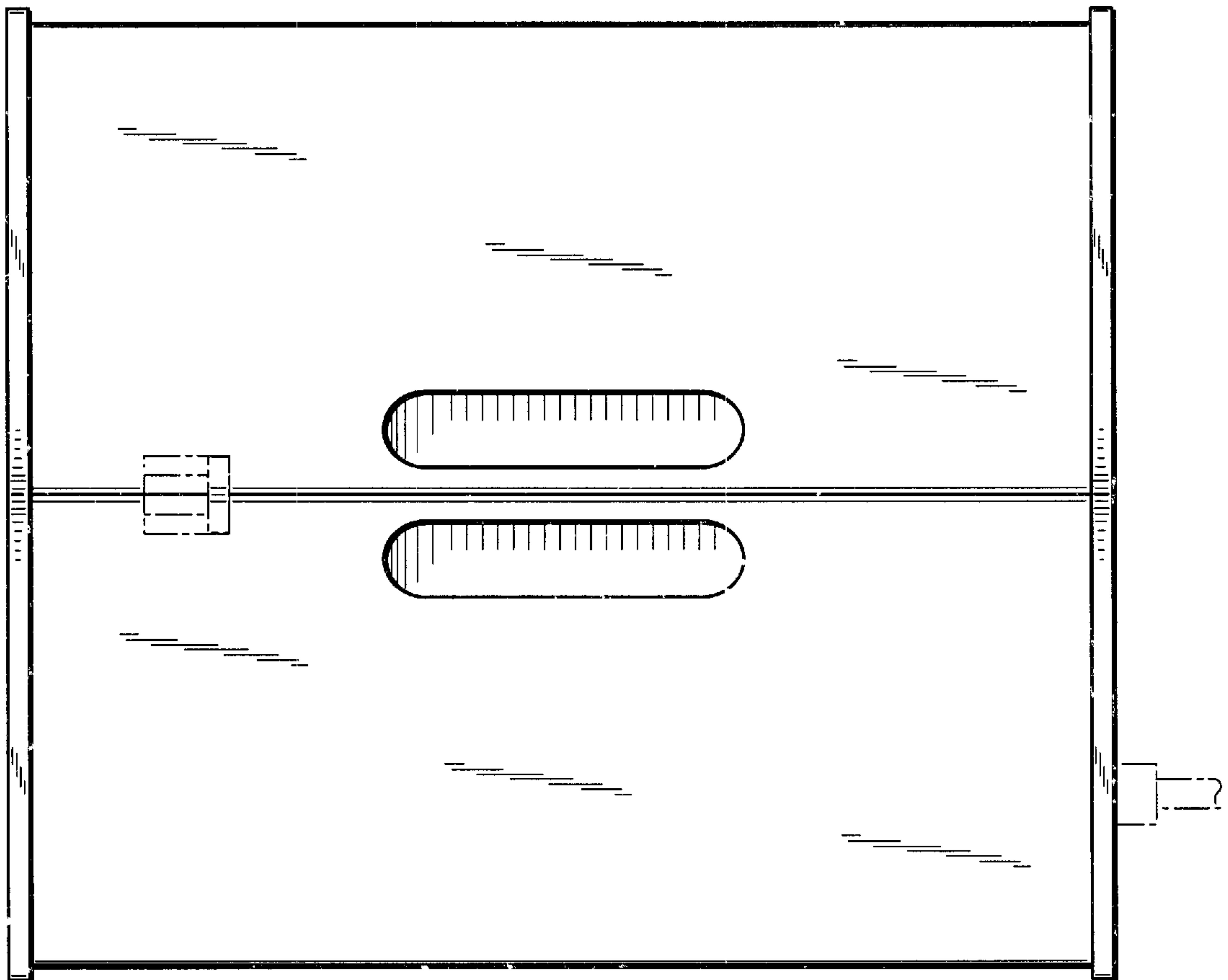



FIG. 7

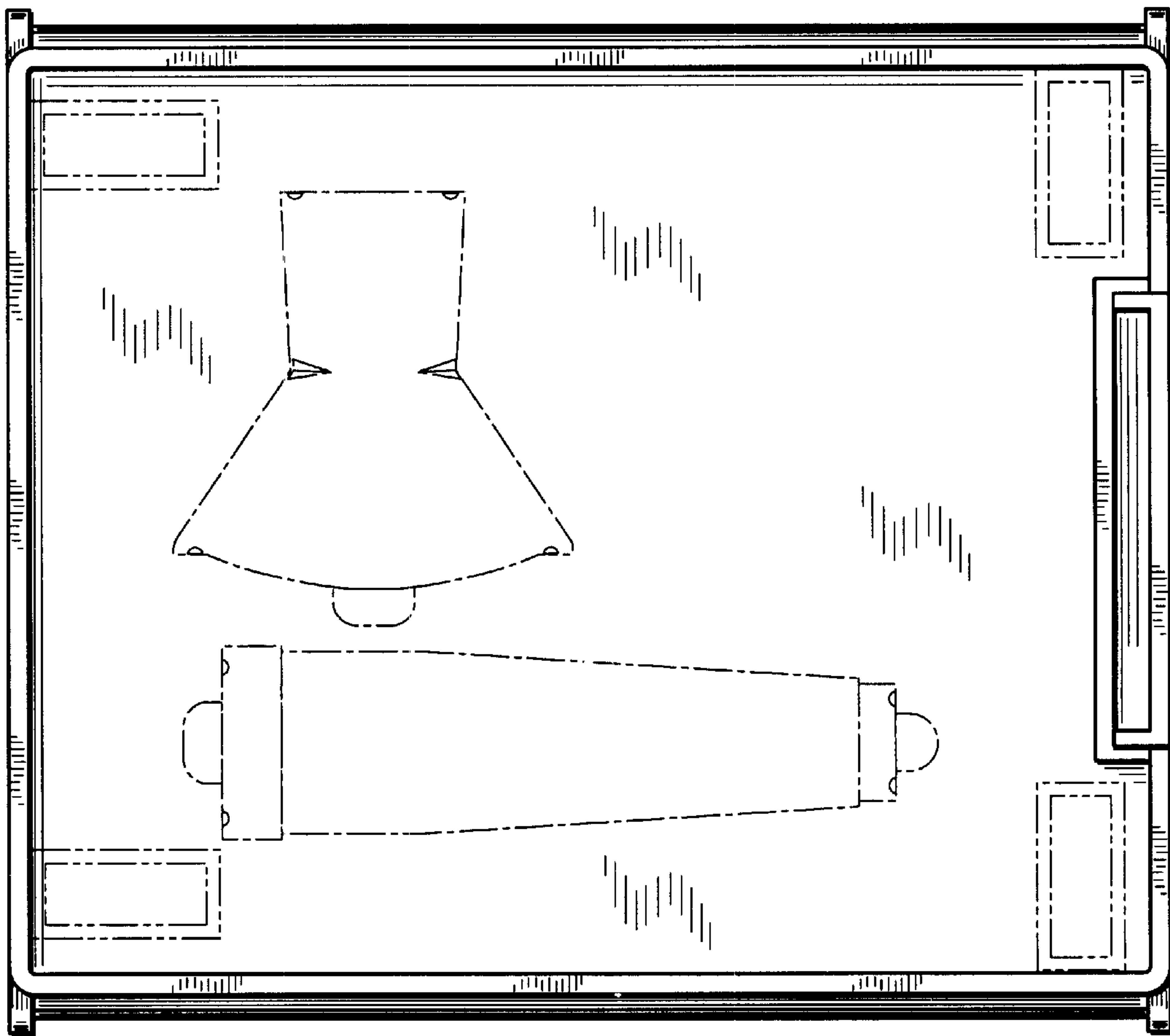



FIG. 8

