



US00D486260S

(12) **United States Design Patent**
Christianson et al.

(10) **Patent No.:** **US D486,260 S**
(45) **Date of Patent:** **** Feb. 3, 2004**

(54) **BOOKLIGHT**

(75) Inventors: **Tristan M. Christianson**, San Francisco, CA (US); **Mark G. Martin**, Monrovia, CA (US)

(73) Assignee: **Sharper Image Corporation**, San Francisco, CA (US)

(**) Term: **14 Years**

(21) Appl. No.: **29/180,091**

(22) Filed: **Apr. 18, 2003**

(51) **LOC (7) Cl.** **26-05**

(52) **U.S. Cl.** **D26/60**

(58) **Field of Search** D26/60-66; 362/98, 362/99, 191, 281-287, 269, 396, 418, 419, 427, 428, 430

(56) **References Cited**

U.S. PATENT DOCUMENTS

5,280,416	A	*	1/1994	Hartley et al.	362/98
D397,468	S	*	8/1998	Zeller	D26/60
D407,517	S	*	3/1999	Zeller	D26/60
D423,130	S		4/2000	Kung	D26/60
6,213,618	B1	*	4/2001	Dobbin et al.	362/99
D446,873	S		8/2001	Fisher et al.	D26/60
6,361,184	B1	*	3/2002	Hallgrimsson et al.	362/427
D464,755	S		10/2002	Harris et al.	D26/60

OTHER PUBLICATIONS

“The Sharper Image” catalog, published by Sharper Image Corporation “Father’s Day 2003”, p. 26, “Hign-Brightness Dual LED Booklight”.

Webpage download on May 27, 2003 from www.sharper-image.com/us/en/catalog/productview.jhtml.

Webpage download on Jul. 22, 2003 from www.amazon.com, Xelco “itty bitty” Book Light.

Webpage download on Jul. 22, 2003 from www.Giftguys.com, Personal Reading Lights.

Webpage download on Jul. 23, 2003 from www.bn.com, Barnes & Noble, Fliplite Junior Booklight.

* cited by examiner

Primary Examiner—Clare E Heflin

(74) *Attorney, Agent, or Firm*—Fliesler Dubb Meyer & Lovejoy LLP

(57) **CLAIM**

The ornamental design for a booklight, as shown and described.

DESCRIPTION

FIG. 1 is a front open perspective view of a book light showing our new design;

FIG. 2 is a rear open perspective view thereof;

FIG. 3 is a right side open view thereof;

FIG. 4 is a left side open view thereof;

FIG. 5 is a rear open view thereof;

FIG. 6 is a front open view thereof;

FIG. 7 is a top open view thereof;

FIG. 8 is a bottom open view thereof;

FIG. 9 is a front closed perspective view thereof;

FIG. 10 is a rear closed perspective view thereof;

FIG. 11 is a right side closed view thereof;

FIG. 12 is a left side closed view thereof;

FIG. 13 is a rear closed view thereof;

FIG. 14 is a front closed view thereof;

FIG. 15 is a top closed view thereof; and,

FIG. 16 is a bottom closed view thereof.

1 Claim, 6 Drawing Sheets

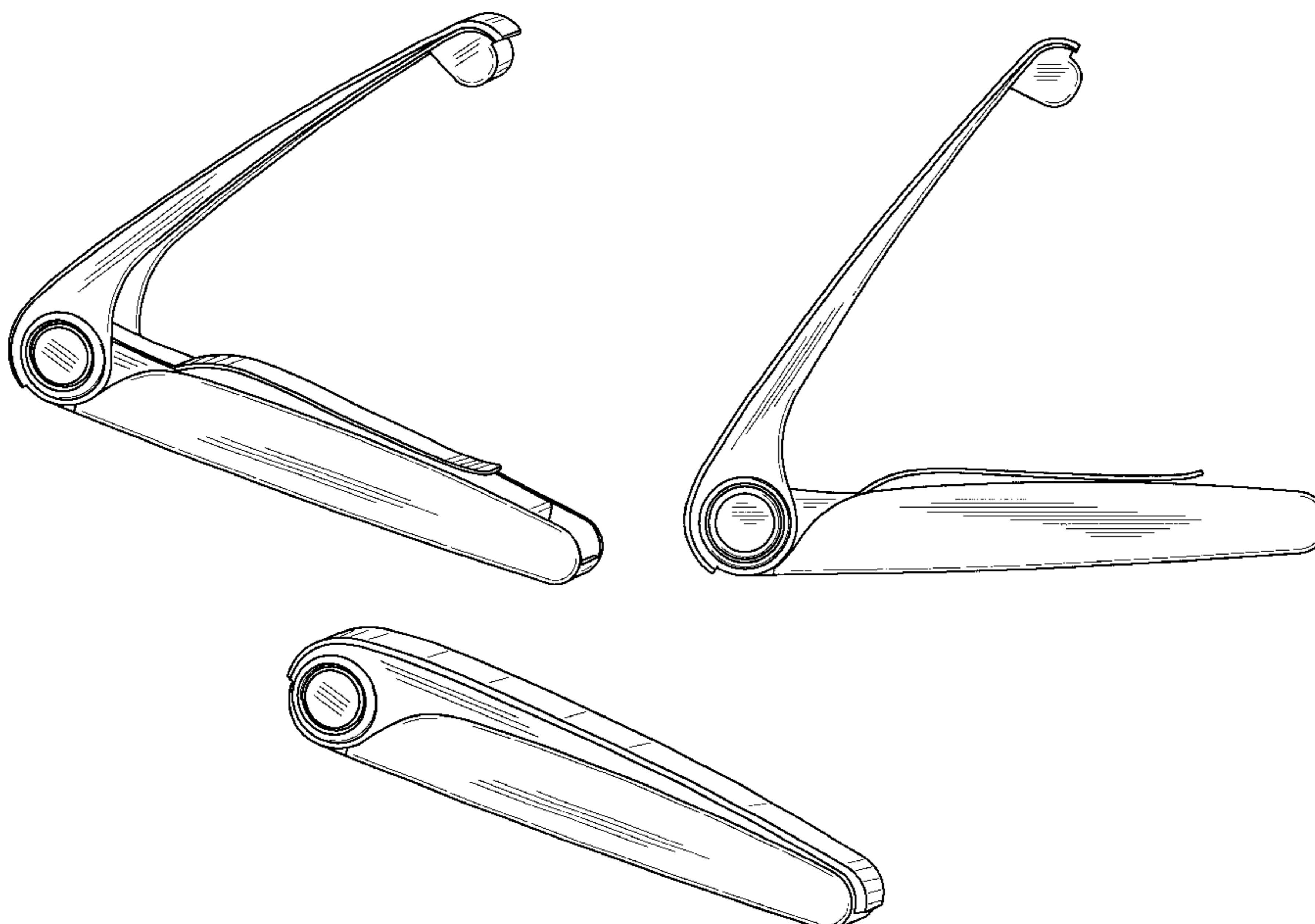

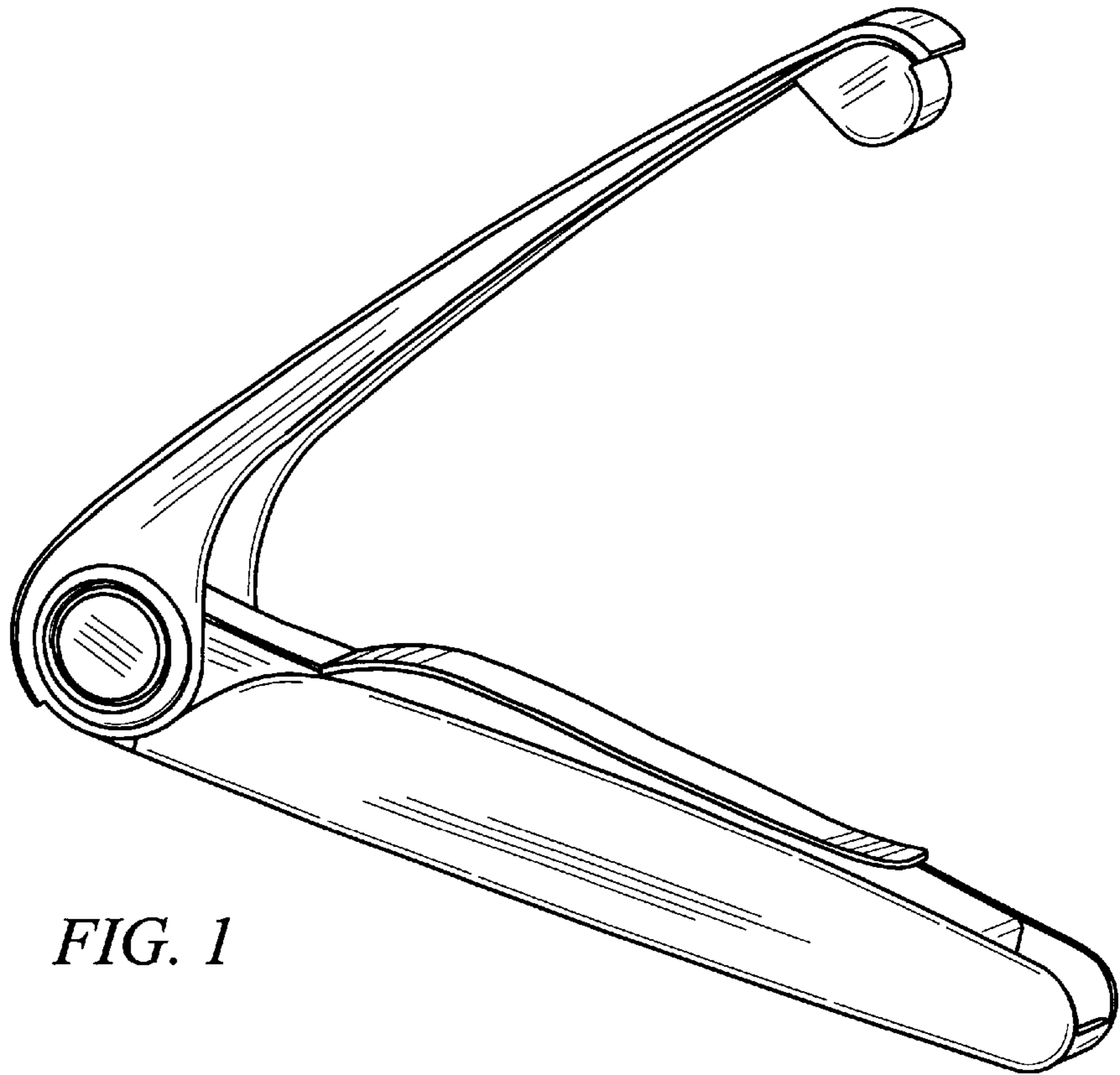

FIG. 1

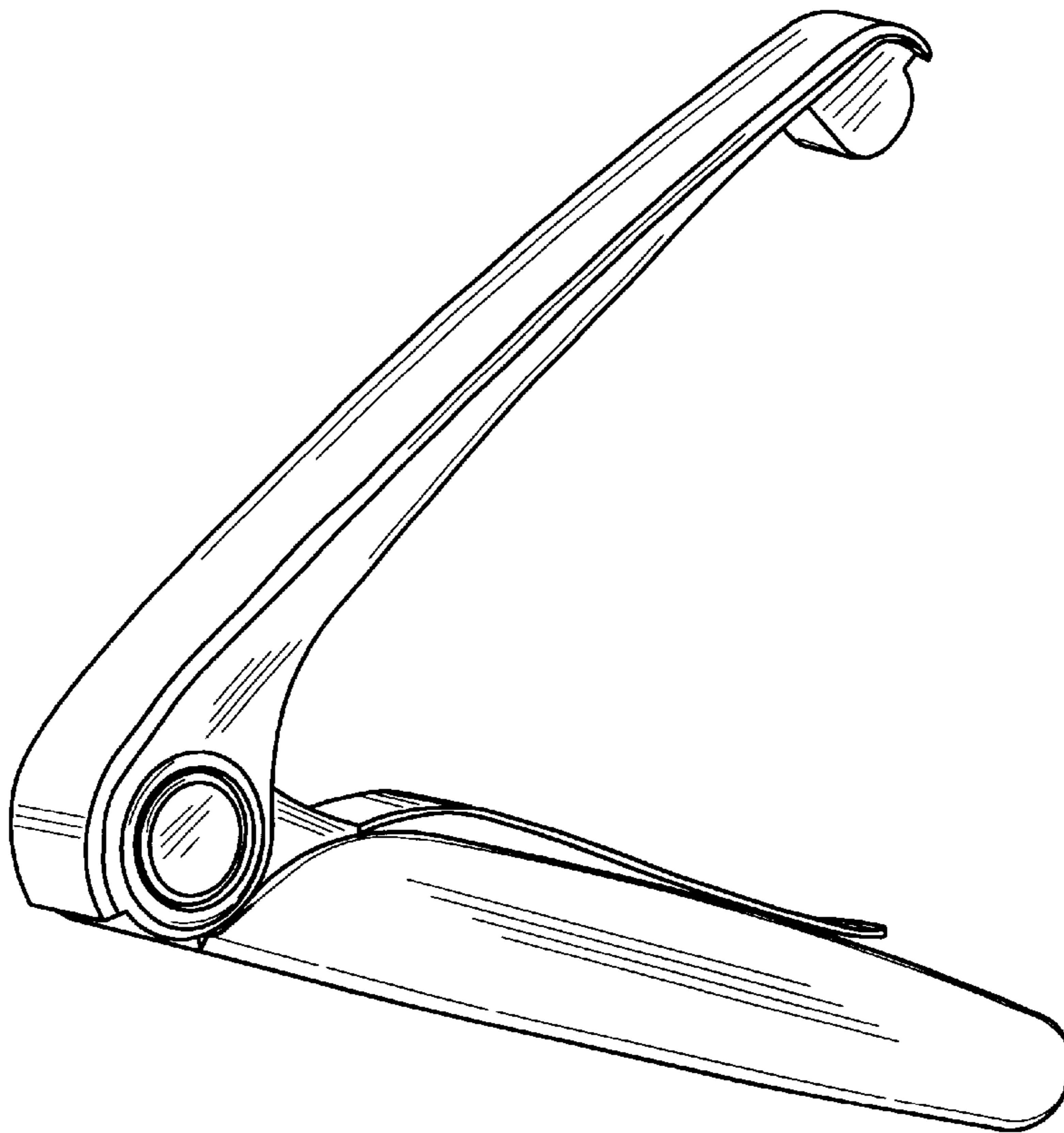

FIG. 2

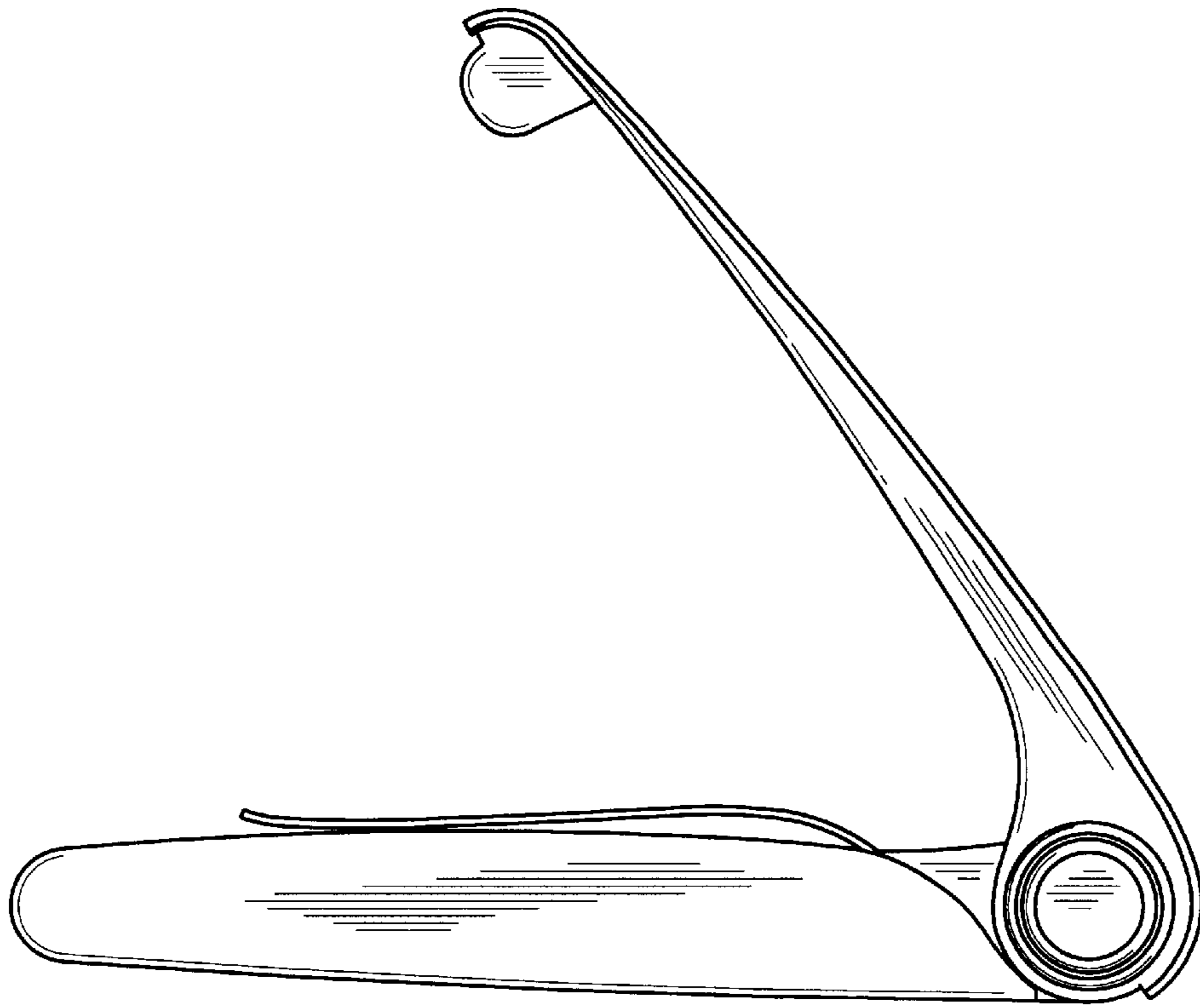

FIG. 3

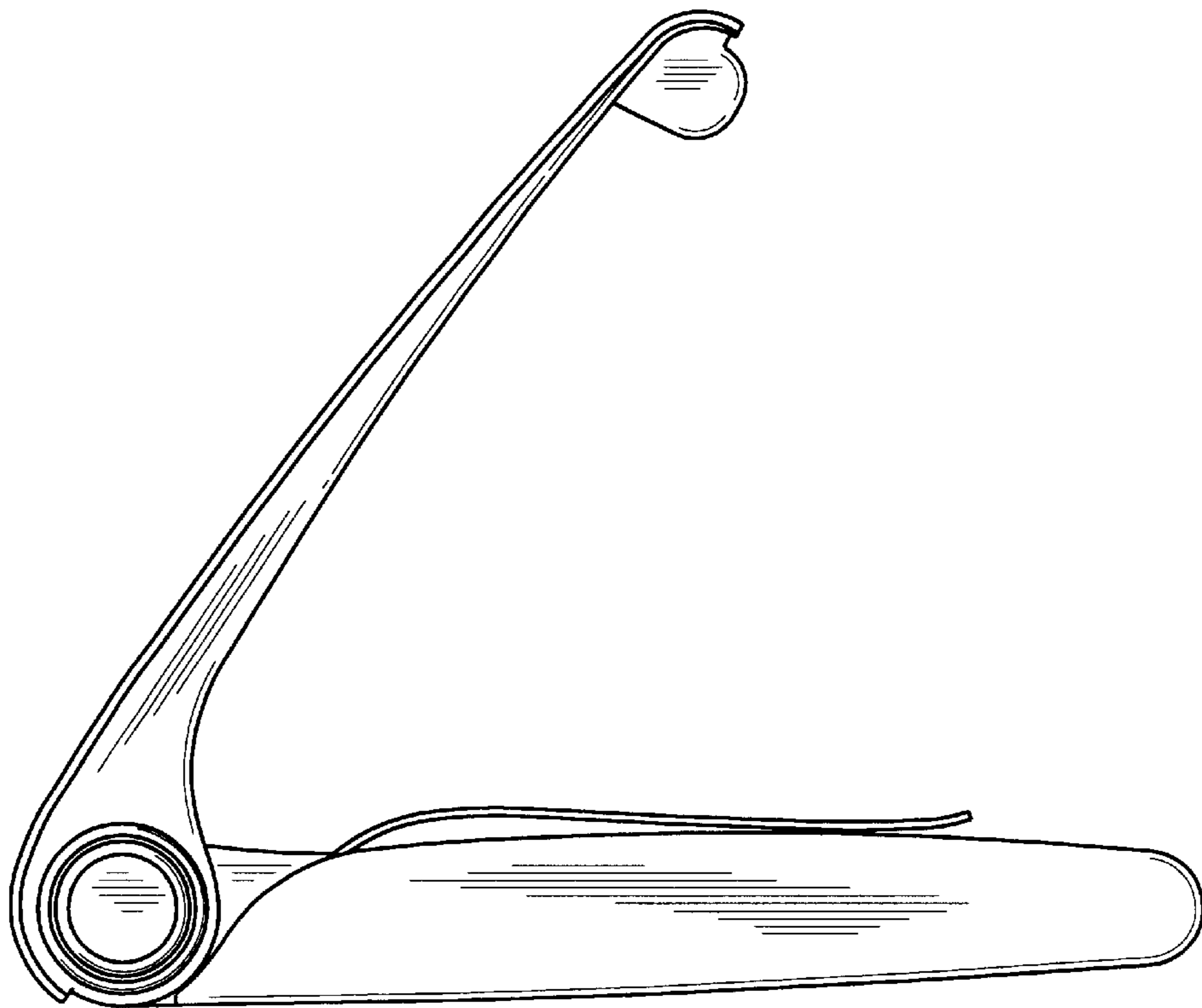

FIG. 4

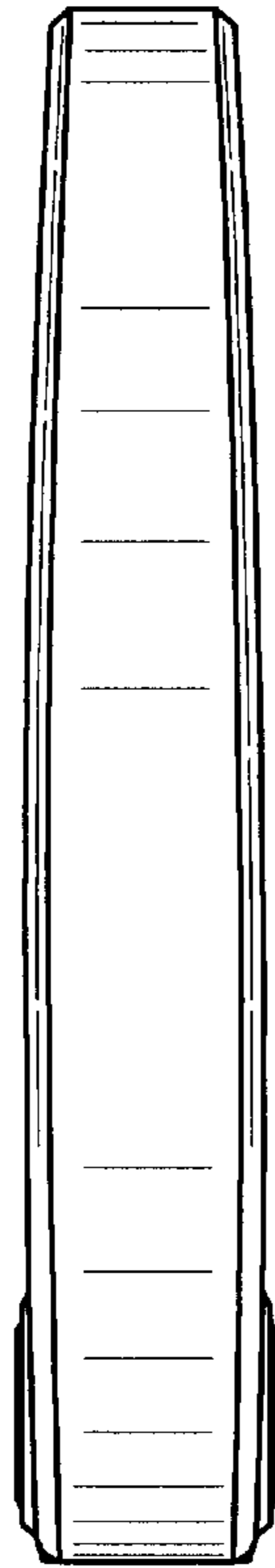

FIG. 5

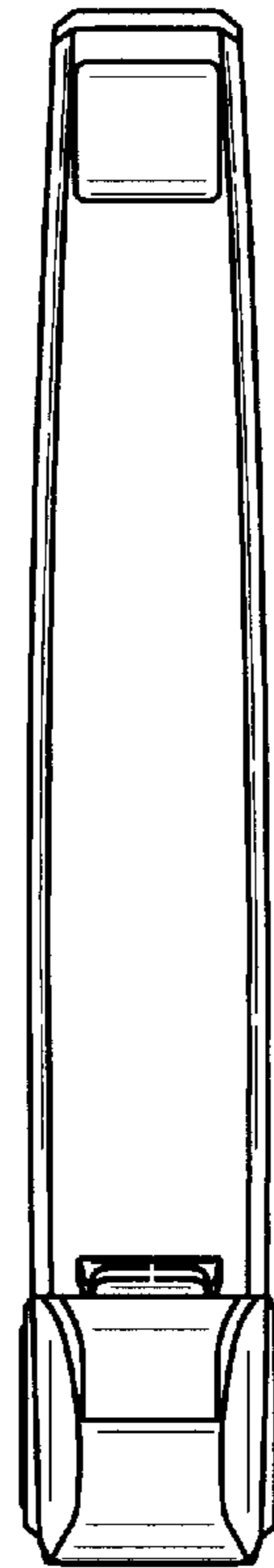

FIG. 6

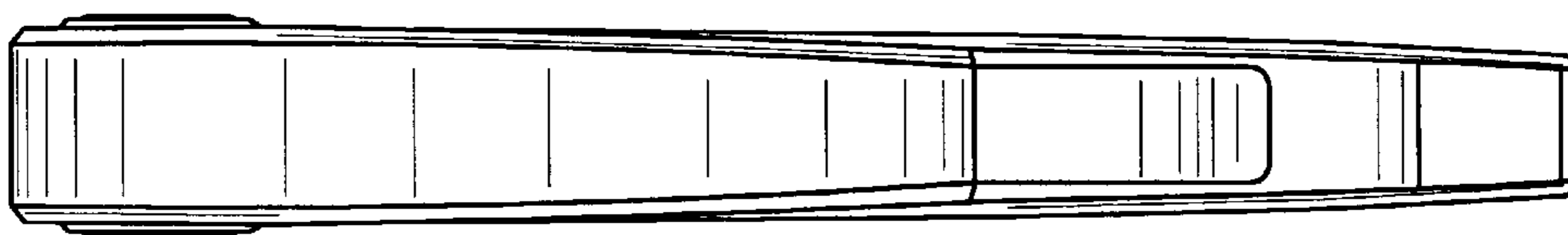

FIG. 7

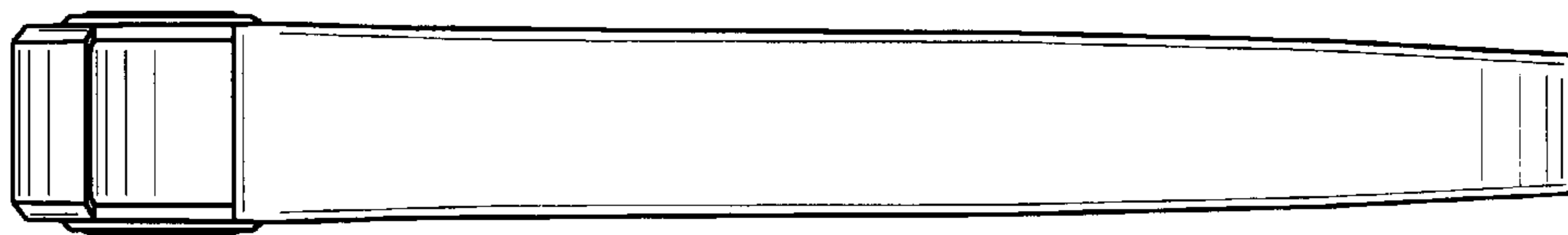

FIG. 8

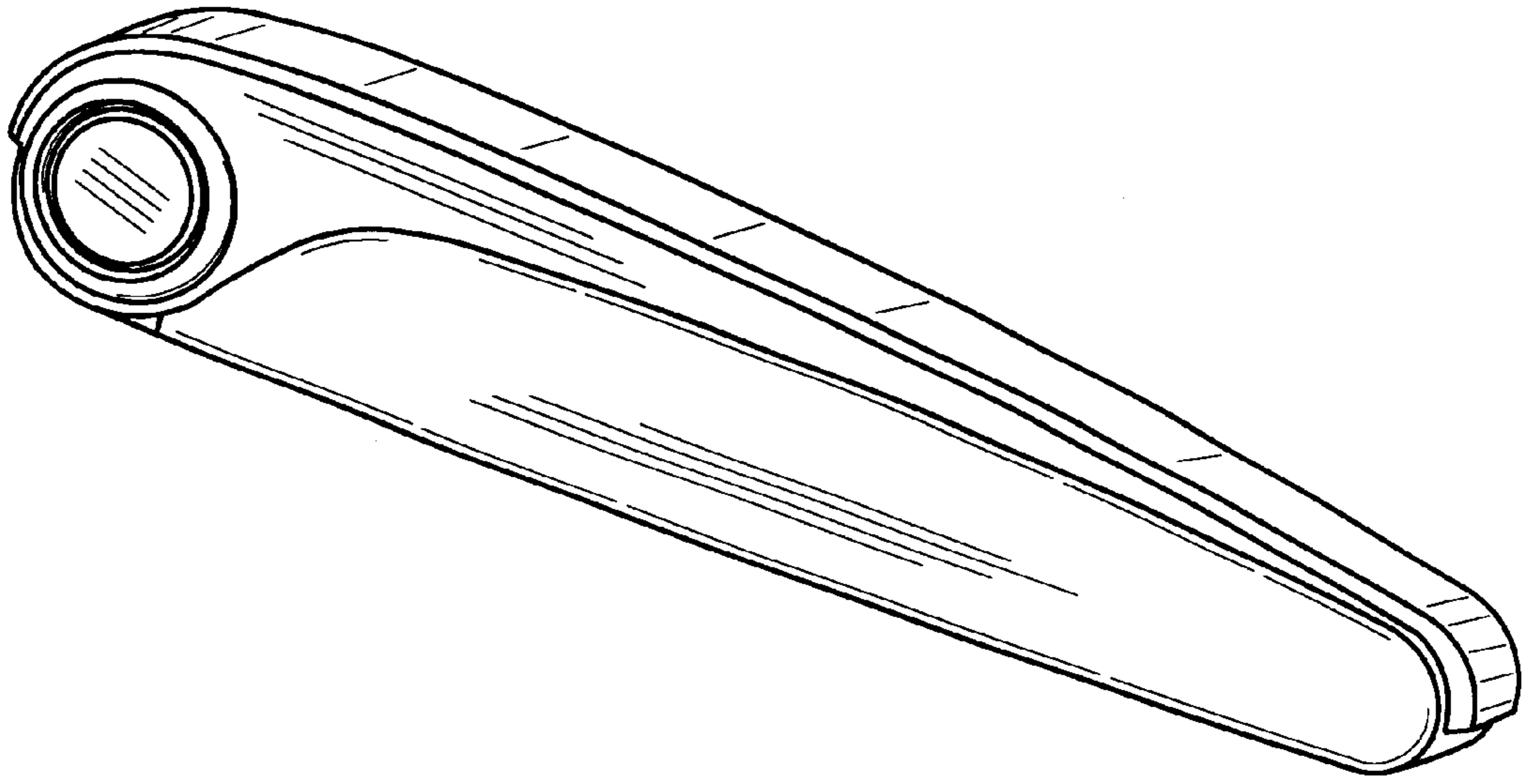

FIG. 9

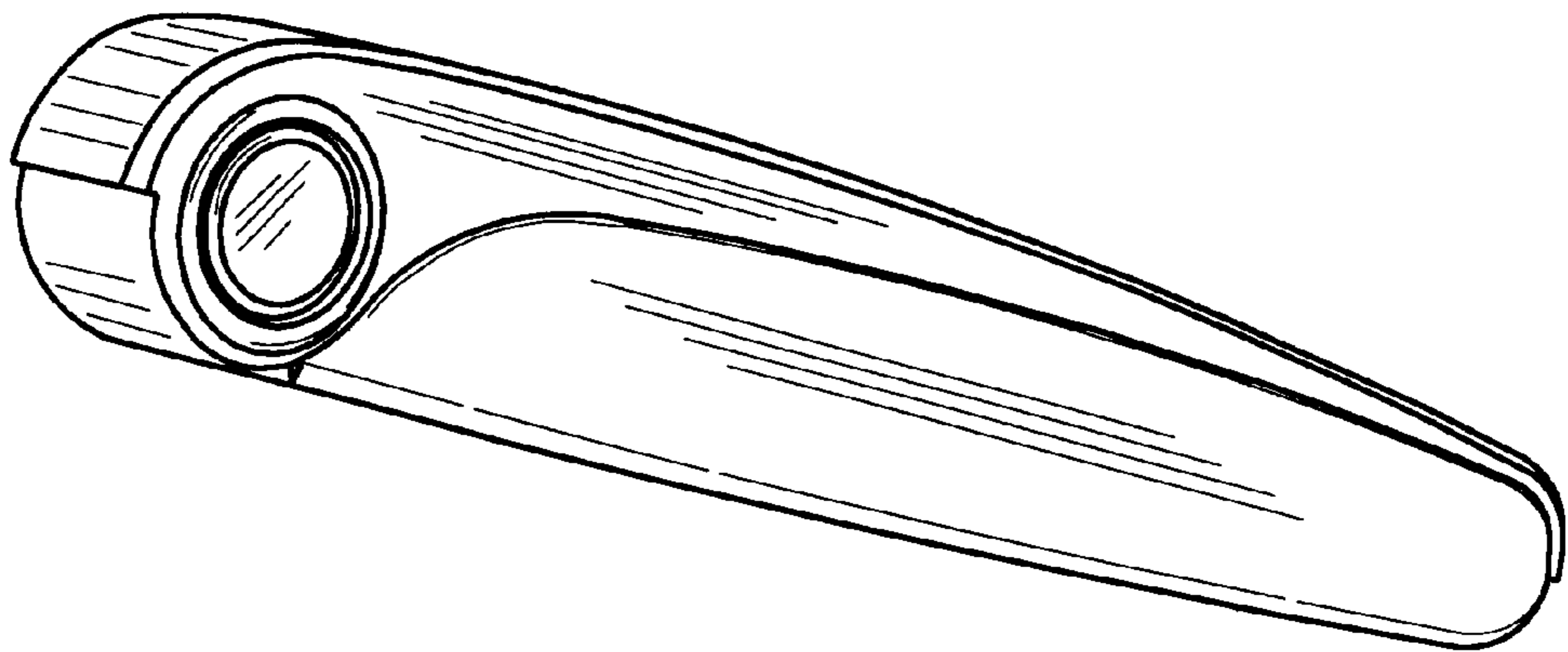

FIG. 10

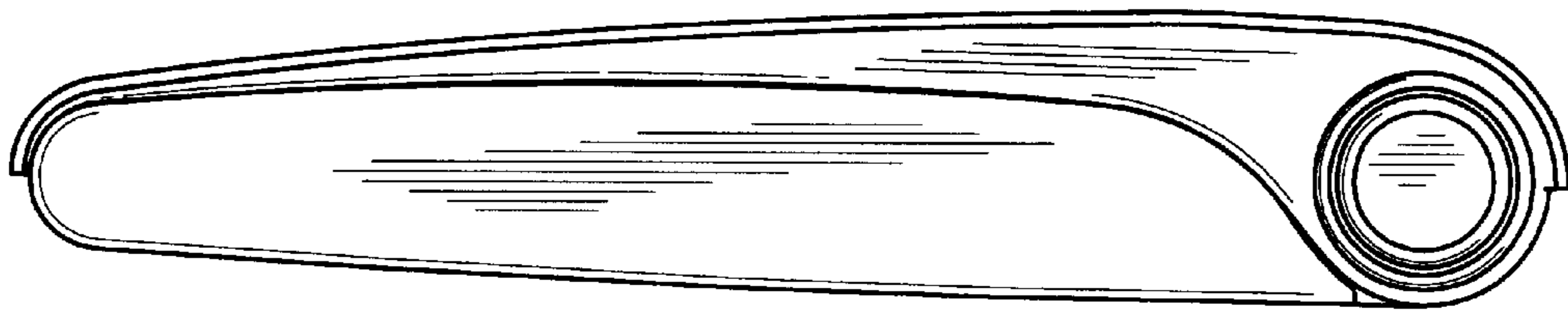

FIG. 11

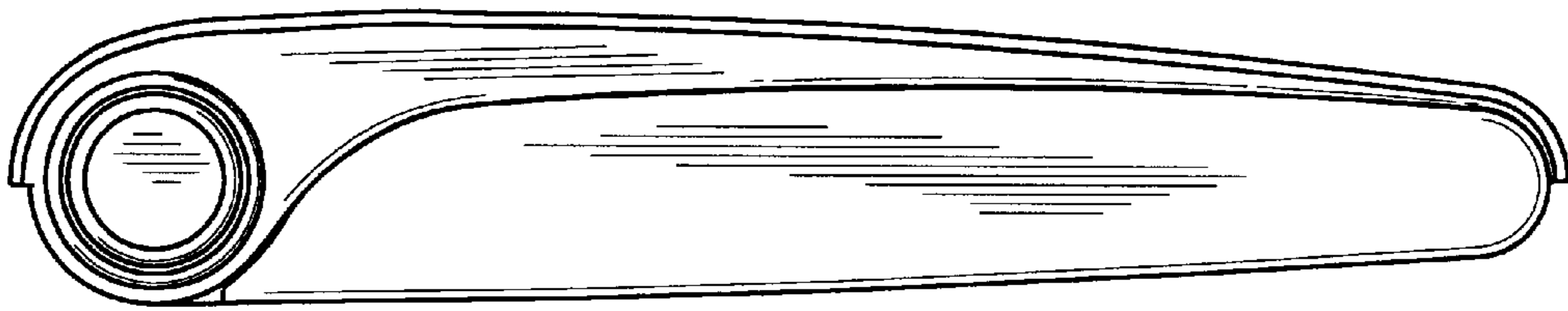

FIG. 12

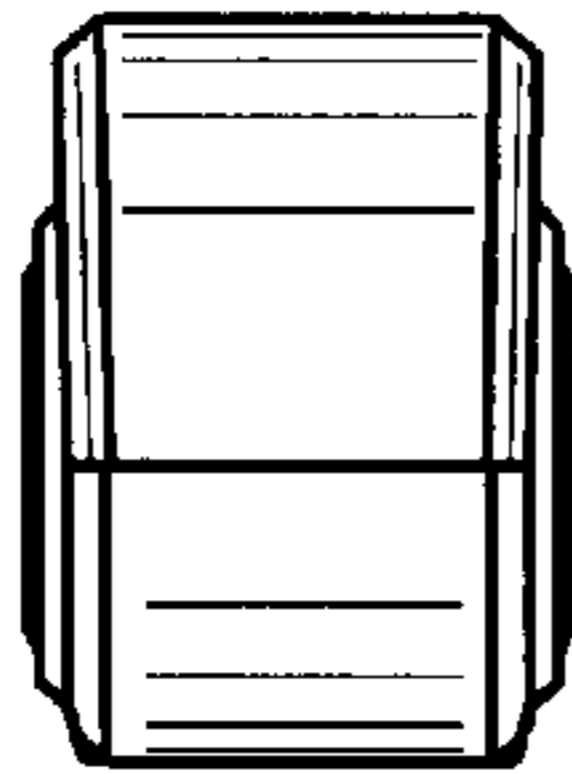

FIG. 13

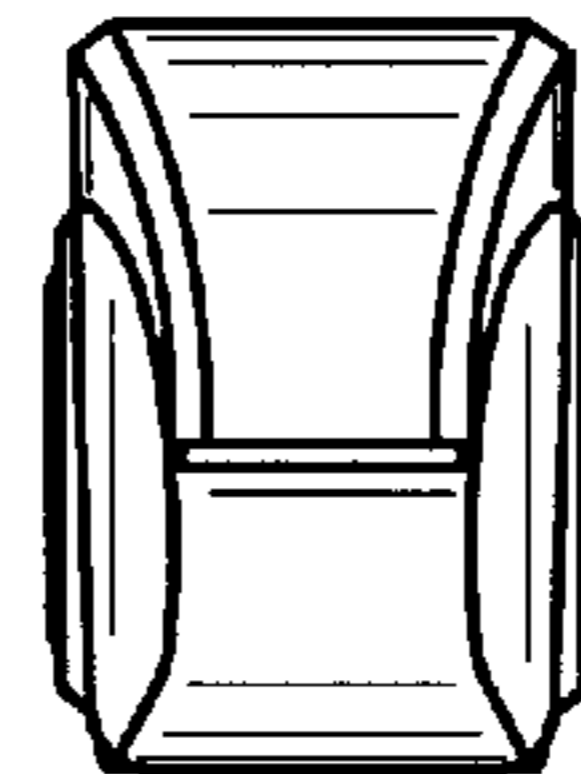

FIG. 14

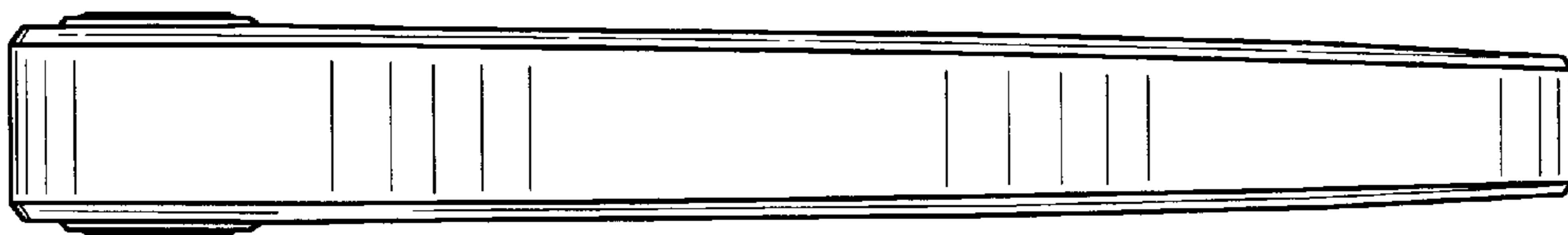

FIG. 15

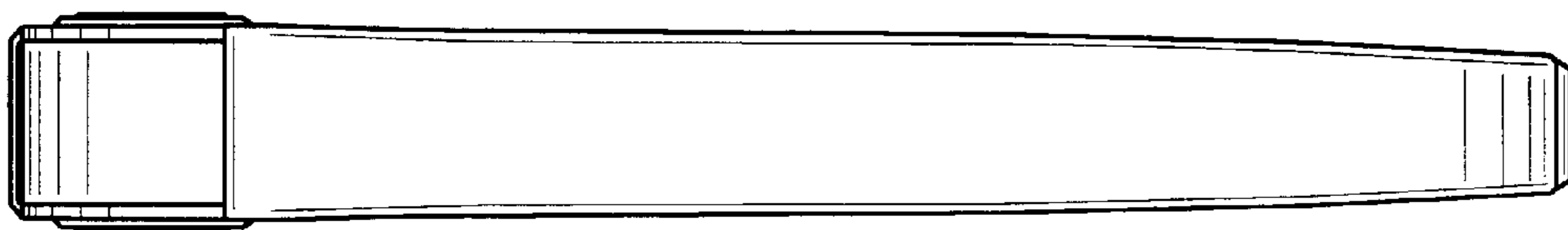

FIG. 16