



US00D486256S

(12) **United States Design Patent**
Yuen

(10) **Patent No.:** **US D486,256 S**

(45) **Date of Patent:** **** Feb. 3, 2004**

(54) **RECHARGEABLE LIGHT**

D403,446 S * 12/1998 Lynch et al. D26/37

D407,170 S * 3/1999 Yuen D26/37

D407,509 S * 3/1999 Yuen D26/37

(75) Inventor: **John Se-Kit Yuen**, Kowloon (HK)

(73) Assignee: **John Manufacturing Limited**,
Kowloon (HK)

* cited by examiner

(**) Term: **14 Years**

Primary Examiner—Marcus A. Jackson

(74) *Attorney, Agent, or Firm*—Mattingly, Stanger &
Malur, P.C.

(21) Appl. No.: **29/173,928**

(57) **CLAIM**

(22) Filed: **Jan. 9, 2003**

The ornamental design for a “rechargeable light”, as shown
and described.

(30) **Foreign Application Priority Data**

Jul. 12, 2002 (GB) 3005292

DESCRIPTION

(51) **LOC (7) Cl.** **26-02**

FIG. 1 is a front view of a rechargeable light showing my
new design;

(52) **U.S. Cl.** **D26/37**

FIG. 2 is a rear view thereof;

(58) **Field of Search** D26/37–50; 362/157,
362/158, 171, 172, 173, 183–208

FIG. 3 is a left side view thereof;

FIG. 4 is a right side thereof;

FIG. 5 is a plan view thereof; and,

FIG. 6 is an underneath plan view thereof.

(56) **References Cited**

U.S. PATENT DOCUMENTS

D392,757 S * 3/1998 Burns D26/37

1 Claim, 3 Drawing Sheets

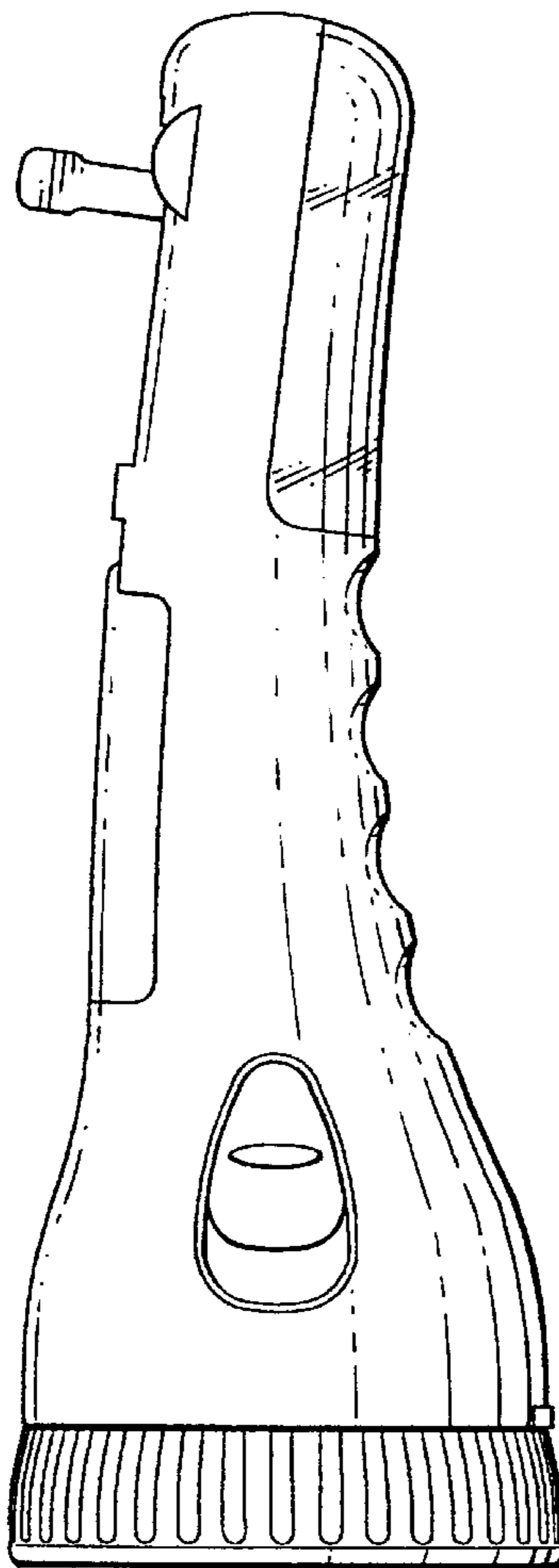

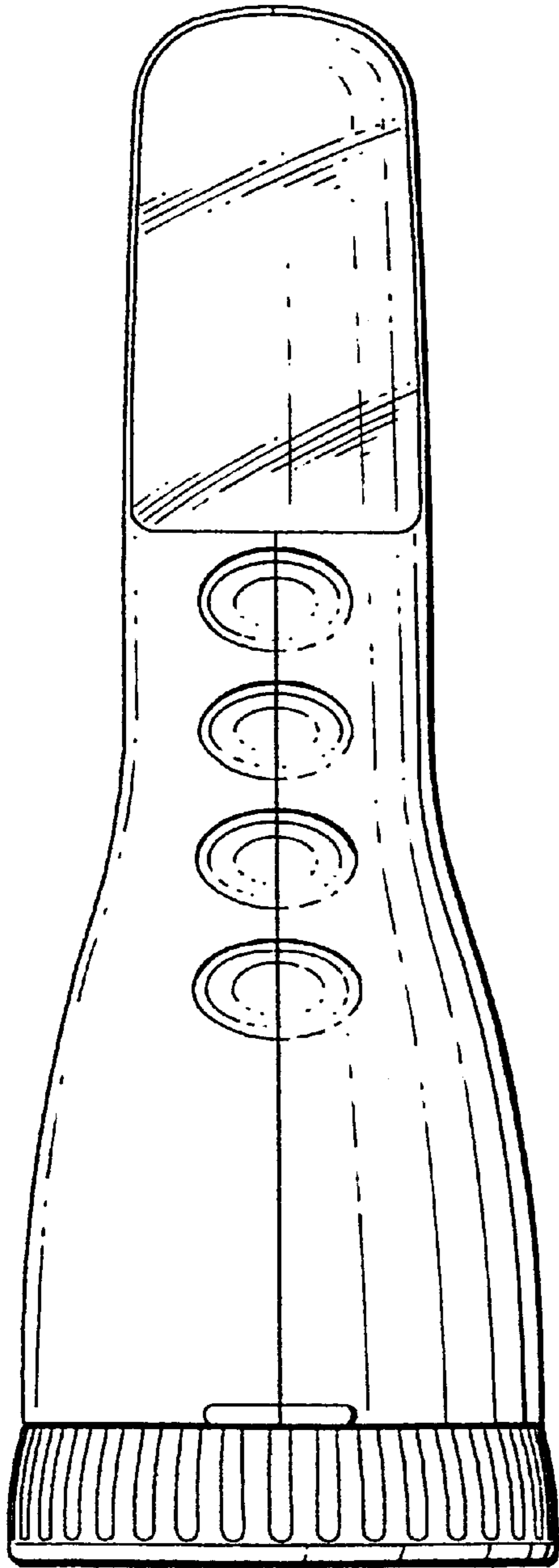

FIG. 1

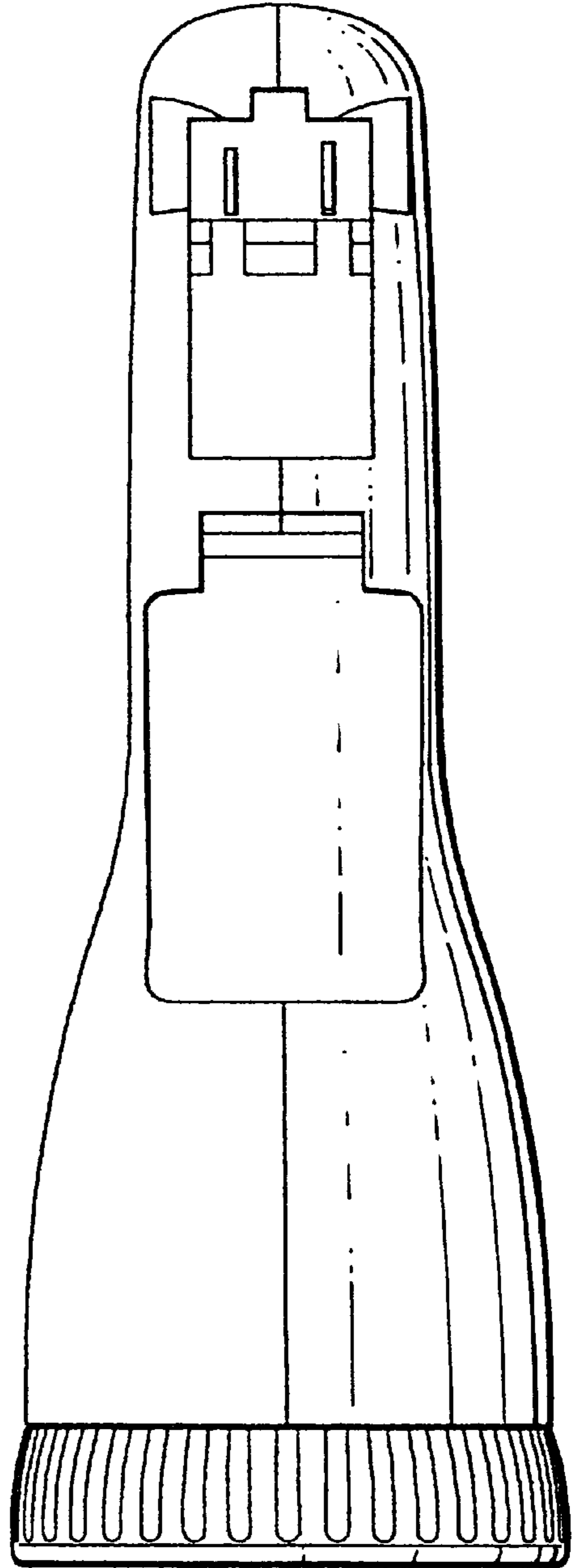

FIG. 2

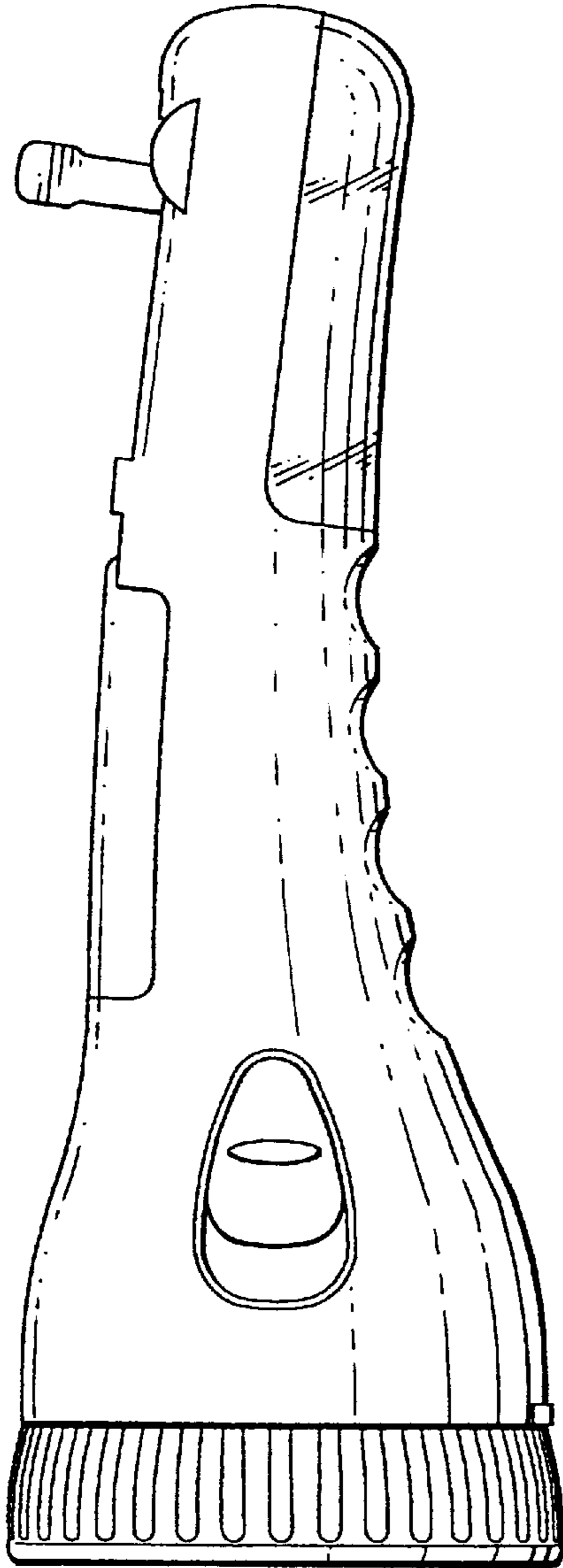

FIG. 3

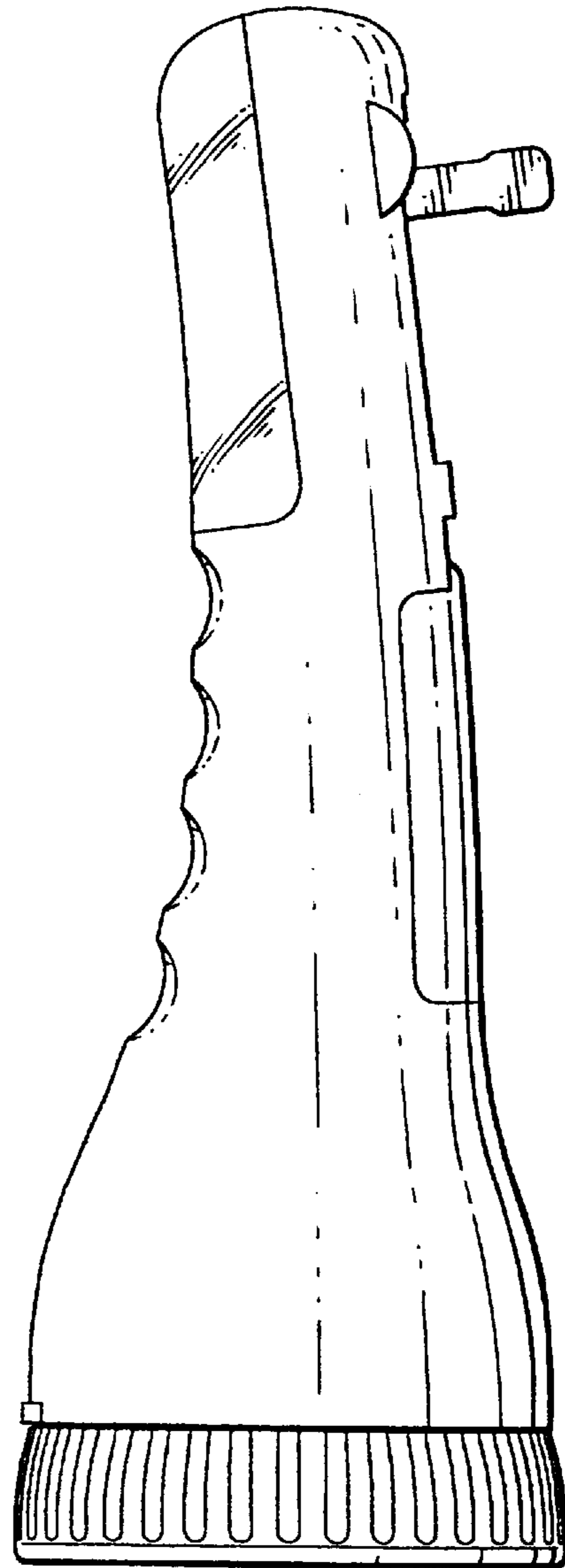

FIG. 4

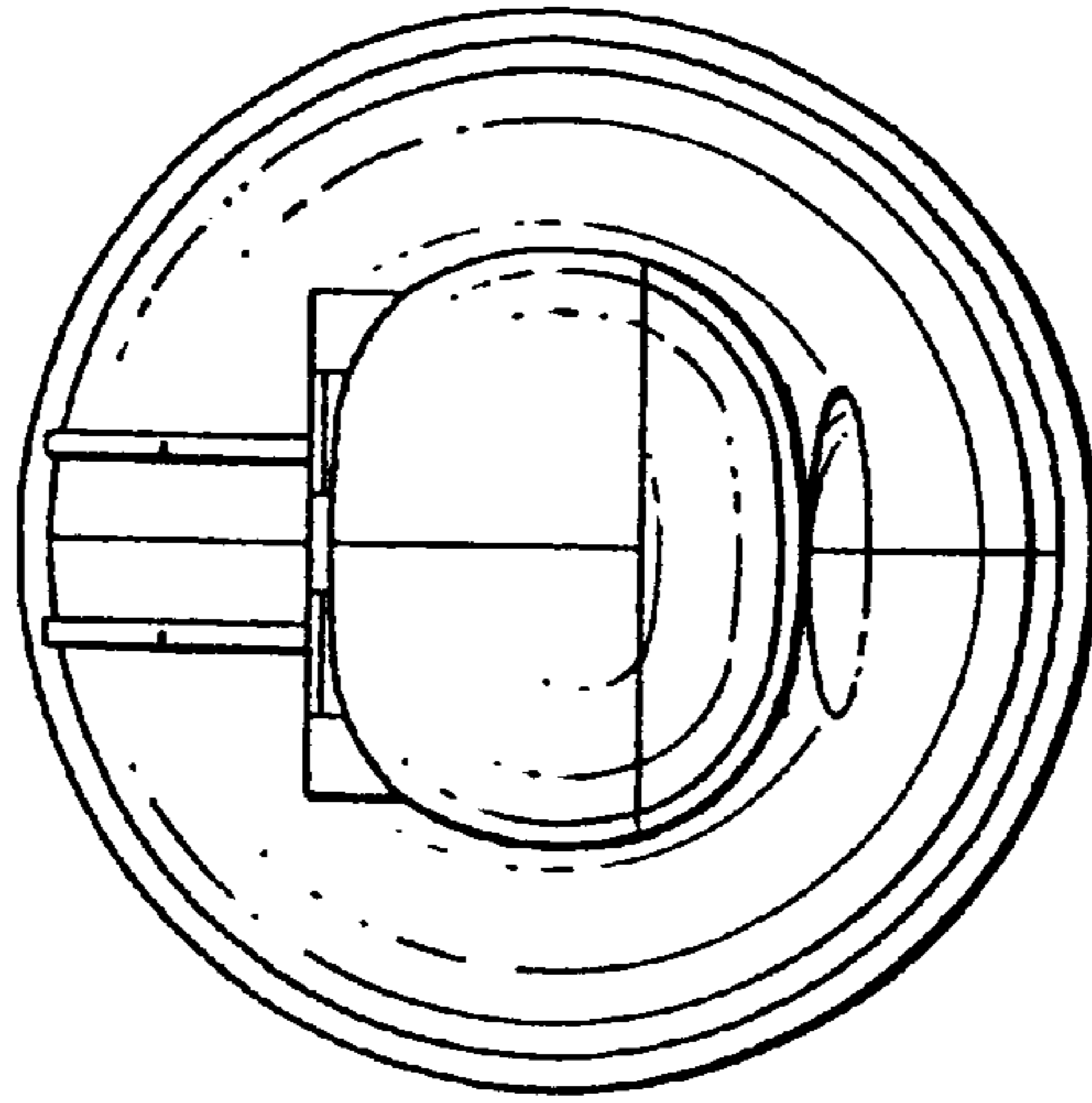

FIG. 5

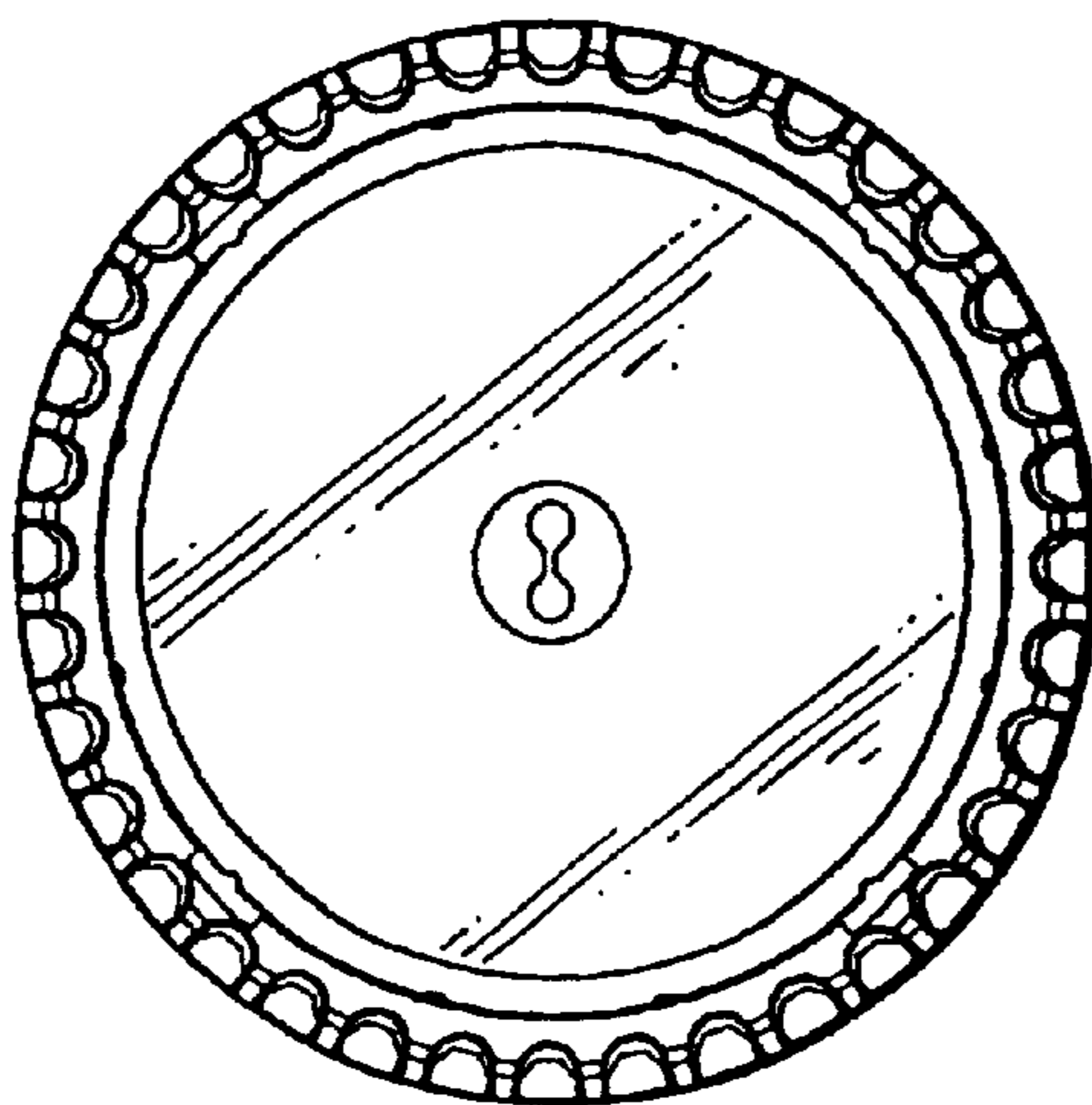

FIG. 6